

Σ-7シリーズ ACサーボドライブ オプションベースユニット 取扱説明書

形式：JEPMC-OP3C01-E

対象サーボパック形式：SGD7C

製品を安全にお使いいただくために、本書を必ずお読みください。

また、本書をお手元に保管していただくとともに、最終的に本製品をご使用になるユーザー様のお手元に確実に届けられるよう、お取り計らい願います。

Σ-7-Series AC Servo Drive Option Base Unit INSTRUCTIONS

Model: JEPMC-OP3C01-E

Applicable SERVOPACK Model: SGD7C

To properly use the product, read this manual thoroughly and retain for easy reference, inspection, and maintenance. Ensure the end user receives this manual.

Entraînement de servomécanisme CA modèles Σ-7 Unité de base en option INSTRUCTIONS

Modèle : JEPMC-O P3C01-E

Modèle de SERVOPACK applicable : SGD7C

Pour utiliser correctement le produit, lisez attentivement ce manuel. Conservez-le comme références et pour les cas d'inspections et de maintenance. Assurez-vous que l'utilisateur final reçoive ce manuel.

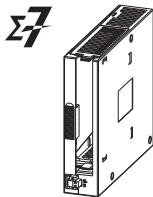

Copyright © 2016 YASKAWA ELECTRIC CORPORATION

All rights reserved. No part of this publication may be reproduced, stored in a retrieval system, or transmitted, in any form, or by any means, mechanical, electronic, photocopying, recording, or otherwise, without the prior written permission of Yaskawa. No patent liability is assumed with respect to the use of the information contained herein. Moreover, because Yaskawa is constantly striving to improve its high-quality products, the information contained in this manual is subject to change without notice. Every precaution has been taken in the preparation of this manual. Nevertheless, Yaskawa assumes no responsibility for errors or omissions. Neither is any liability assumed for damages resulting from the use of the information contained in this publication.

Safety Precautions

◆ Safety Information

To prevent personal injury and equipment damage in advance, the following signal words are used to indicate safety precautions in this document. The signal words are used to classify the hazards and the degree of damage or injury that may occur if a product is used incorrectly. Information marked as shown below is important for safety. Always read this information and heed the precautions that are provided.



DANGER

- Indicates precautions that, if not heeded, are likely to result in loss of life, serious injury, or fire.



WARNING

- Indicates precautions that, if not heeded, could result in loss of life, serious injury, or fire.



CAUTION

- Indicates precautions that, if not heeded, could result in relatively serious or minor injury, or in fire.

NOTICE

- Indicates precautions that, if not heeded, could result in property damage.

◆ Safety Precautions That Must Always Be Observed

■ General Precautions



WARNING

- Read and understand this manual to ensure the safe usage of the product.
- Keep this manual in a safe, convenient place so that it can be referred to whenever necessary. Make sure that it is delivered to the final user of the product.
- The installation must be suitable and it must be performed only by an experienced technician.
There is a risk of electrical shock or injury.
- Before connecting the machine and starting operation, make sure that an emergency stop procedure has been provided and is working correctly.
There is a risk of injury.
- Do not approach the machine after a momentary interruption to the power supply. When power is restored, the product and the device connected to it may start operation suddenly. Provide safety measures in advance to ensure human safety when operation restarts.
There is a risk of injury.
- Do not touch anything inside the product.
There is a risk of electrical shock.
- Do not remove the front cover, cables, connector, or options while power is being supplied.
There is a risk of electrical shock, malfunction, or damage.
- Do not damage, pull on, apply excessive force to, place heavy objects on, or pinch the cables.
There is a risk of electrical shock, operational failure of the product, or burning.
- Do not attempt to modify the product in any way.
There is a risk of injury or device damage.

■ Storage and Transportation Precautions

CAUTION

- Do not store the product in any of the following locations.
 - Locations that are subject to direct sunlight
 - Locations that are subject to ambient temperatures that exceed the storage conditions
 - Locations that are subject to ambient humidity that exceeds the storage conditions
 - Locations that are subject to rapid temperature changes and condensation
 - Locations that are subject to corrosive or inflammable gas
 - Locations that are subject to excessive dust, dirt, salt, or metallic powder
 - Locations that are subject to water, oil, or chemicals
 - Locations that are subject to vibration or shockThere is a risk of fire, electrical shock, or device damage.
- Hold onto the main body of the product when transporting it.
Holding the cables or connectors may damage them or result in injury.
- Do not overload the product during transportation. (Follow all instructions.)
There is a risk of injury or an accident.
- Never subject the product to an atmosphere containing halogen (fluorine, chlorine, bromine, or iodine) during transportation.
There is a risk of malfunction or damage.
- If disinfectants or insecticides must be used to treat packing materials such as wooden frames, pallets, or plywood, the packing materials must be treated before the product is packaged, and methods other than fumigation must be used.
Example: Heat treatment, where materials are kiln-dried to a core temperature of 56°C for 30 minutes or more.
If the electronic products, which include stand-alone products and products installed in machines, are packed with fumigated wooden materials, the electrical components may be greatly damaged by the gases or fumes resulting from the fumigation process. In particular, disinfectants containing halogen, which includes chlorine, fluorine, bromine, or iodine can contribute to the erosion of the capacitors.

■ Installation Precautions

CAUTION

- **Do not install the product in any of the following locations.**
 - Locations that are subject to direct sunlight
 - Locations that are subject to ambient temperatures that exceed the operating conditions
 - Locations that are subject to ambient humidity that exceeds the operating conditions
 - Locations that are subject to rapid temperature changes and condensation
 - Locations that are subject to corrosive or inflammable gas
 - Locations that are subject to excessive dust, dirt, salt, or metallic powder
 - Locations that are subject to water, oil, or chemicals
 - Locations that are subject to vibration or shock
There is a risk of fire, electrical shock, or device damage.
- **Never install the product in an atmosphere containing halogen (fluorine, chlorine, bromine, or iodine).**
There is a risk of malfunction or damage.
- **Do not step on the product or place heavy objects on the product.**
There is a risk of injury or an accident.
- **Do not block the air exhaust ports on the product. Do not allow foreign objects to enter the product.**
There is a risk of internal element deterioration, malfunction, or fire.
- **Always mount the product in the specified orientation.**
There is a risk of malfunction.
- **Leave the specified amount of space between the product, and the interior surface of the control panel and other devices.**
There is a risk of fire or malfunction.
- **Do not subject the product to strong shock.**
There is a risk of malfunction.

■ Wiring Precautions



CAUTION

- Check the wiring to be sure it has been performed correctly.
There is a risk of motor run-away, injury, or accidents.
- Always use a power supply of the specified voltage.
There is a risk of fire or accident.
- In places with poor power supply conditions, ensure that the input power is supplied within the specified voltage range.
There is a risk of device damage.
- Install breakers and other safety measures to provide protection against shorts in external wiring.
There is a risk of fire.
- Provide sufficient shielding when using the product in the following locations.
 - Locations that are subject to noise, such as from static electricity
 - Locations that are subject to strong electromagnetic or magnetic fields
 - Locations that are subject to radiation
 - Locations that are near power linesThere is a risk of device damage.
- Configure the circuits to turn ON the control power supply for the SERVOPACK before the 24-V I/O power supply.
If the control power supply for the SERVOPACK is turned ON after the external power supply, e.g., the 24-V I/O power supply, the outputs from the Option Module may momentarily turn ON when the control power supply for the SERVOPACK turns ON. This can result in unexpected operation that may cause injury or device damage.
- Provide emergency stop circuits, interlock circuits, limit circuits, and any other required safety measures in control circuits outside of the product.
There is a risk of injury or device damage.
- If you use MECHATROLINK I/O Modules, use the establishment of MECHATROLINK communications as an interlock output condition.
There is a risk of device damage.

CAUTION

- Select the I/O signal wires for external wiring to connect the product to external devices based on the following criteria:
 - Mechanical strength
 - Noise interference
 - Wiring distance
 - Signal voltage
- Wire the 24-VDC power supply for the Option Base Unit so that it can be turned ON and OFF from the input (AC) side.
There is a risk of failure if you turn the 24-VDC power supply ON and OFF from its output (DC) side.
- Wire the power supply connector for the Option Base Unit so that the sheath is not exposed.
- Separate the I/O signal cables for control circuits from the power cables both inside and outside the control panel to reduce the influence of noise from the power cables.
If the I/O signal lines and power lines are not separated properly, malfunction may occur.

Example of Separated Cables

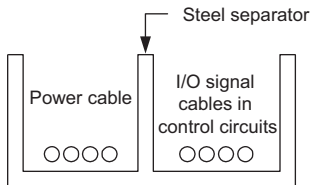

■ Operation Precautions



CAUTION

- Follow the procedures and instructions in the user's manuals for the relevant products to perform normal operation and trial operation. Operating mistakes while the Servomotor and machine are connected may damage the machine or even cause accidents resulting in injury or death.
- Implement interlock signals and other safety circuits external to the product to ensure safety in the overall system even if the following conditions occur.
 - Product failure or errors caused by external factors
 - Shutdown of operation due to product detection of an error in self-diagnosis and the subsequent turning OFF or holding of output signals
 - Holding of the ON or OFF status of outputs from the product due to fusing or burning of output relays or damage to output transistors
 - Voltage drops from overloads or short-circuits in the 24-V output from the product and the subsequent inability to output signals
 - Unexpected outputs due to errors in the power supply, I/O, or memory that cannot be detected by the product through self-diagnosisThere is a risk of injury, device damage, or burning.

■ Maintenance and Inspection Precautions



CAUTION

- Do not attempt to disassemble or repair the product. There is a risk of electrical shock, injury, or device damage.
- Do not change any wiring while power is being supplied. There is a risk of electrical shock, injury, or device damage.

■ Disposal Precautions

- Dispose of the product as general industrial waste.

■ Other General Precautions

- The products shown in the illustrations in this manual are sometimes shown without covers or protective guards. Always replace the cover or protective guard as specified first, and then operate the products in accordance with the manual.
- The illustrations that are presented in this manual are typical examples and may not match the product you received.
- If the manual must be ordered due to loss or damage, inform your nearest Yaskawa representative or one of the offices listed on the back of this manual.

Warranty

◆ Details of Warranty

■ Warranty Period

The warranty period for a product that was purchased (hereinafter called “delivered product”) is one year from the time of delivery to the location specified by the customer or 18 months from the time of shipment from the Yaskawa factory, whichever is sooner.

■ Warranty Scope

Yaskawa shall replace or repair a defective product free of charge if a defect attributable to Yaskawa occurs during the warranty period above. This warranty does not cover defects caused by the delivered product reaching the end of its service life and replacement of parts that require replacement or that have a limited service life.

This warranty does not cover failures that result from any of the following causes.

- Improper handling, abuse, or use in unsuitable conditions or in environments not described in product catalogs or manuals, or in any separately agreed-upon specifications
- Causes not attributable to the delivered product itself
- Modifications or repairs not performed by Yaskawa
- Use of the delivered product in a manner in which it was not originally intended
- Causes that were not foreseeable with the scientific and technological understanding at the time of shipment from Yaskawa
- Events for which Yaskawa is not responsible, such as natural or human-made disasters

◆ Limitations of Liability

- Yaskawa shall in no event be responsible for any damage or loss of opportunity to the customer that arises due to failure of the delivered product.
- Yaskawa shall not be responsible for any programs (including parameter settings) or the results of program execution of the programs provided by the user or by a third party for use with programmable Yaskawa products.
- The information described in product catalogs or manuals is provided for the purpose of the customer purchasing the appropriate product for the intended application. The use thereof does not guarantee that there are no infringements of intellectual property rights or other proprietary rights of Yaskawa or third parties, nor does it construe a license.
- Yaskawa shall not be responsible for any damage arising from infringements of intellectual property rights or other proprietary rights of third parties as a result of using the information described in catalogs or manuals.

◆ Suitability for Use

- It is the customer's responsibility to confirm conformity with any standards, codes, or regulations that apply if the Yaskawa product is used in combination with any other products.
- The customer must confirm that the Yaskawa product is suitable for the systems, machines, and equipment used by the customer.
- Consult with Yaskawa to determine whether use in the following applications is acceptable. If use in the application is acceptable, use the product with extra allowance in ratings and specifications, and provide safety measures to minimize hazards in the event of failure.
 - Outdoor use, use involving potential chemical contamination or electrical interference, or use in conditions or environments not described in product catalogs or manuals
 - Nuclear energy control systems, combustion systems, railroad systems, aviation systems, vehicle systems, medical equipment, amusement machines, and installations subject to separate industry or government regulations
 - Systems, machines, and equipment that may present a risk to life or property
 - Systems that require a high degree of reliability, such as systems that supply gas, water, or electricity, or systems that operate continuously 24 hours a day
 - Other systems that require a similar high degree of safety
- Never use the product for an application involving serious risk to life or property without first ensuring that the system is designed to secure the required level of safety with risk warnings and redundancy, and that the Yaskawa product is properly rated and installed.
- The circuit examples and other application examples described in product catalogs and manuals are for reference. Check the functionality and safety of the actual devices and equipment to be used before using the product.
- Read and understand all use prohibitions and precautions, and operate the Yaskawa product correctly to prevent accidental harm to third parties.

◆ Specifications Change

The names, specifications, appearance, and accessories of products in product catalogs and manuals may be changed at any time based on improvements and other reasons. The next editions of the revised catalogs or manuals will be published with updated code numbers. Consult with your Yaskawa representative to confirm the actual specifications before purchasing a product.

Contents

Safety Precautions	1
Warranty	8

1 Confirmations Upon Delivery 12

1.1 Nameplate	12
-------------------------	----

2 Specifications 14

2.1 Installation and Operating Conditions	14
2.2 Specifications	15
2.3 Appearance and Part Names	16
2.4 External Dimensions	17
2.5 Option Modules	18

3 Installation 20

3.1 Precautions for the Installation Location	20
3.2 Mounting Interval	21
3.3 Connecting an Option Base Unit	23
3.4 Installing an Option Module	24
3.5 Replacing an Option Module	25

4 Wiring 28

4.1 Power Supply Connector	28
4.2 Connection Method	28

5 Inspections 30

5.1 Daily Inspections	30
5.2 Periodic Inspections	31
5.3 Replacement Guidelines for Product Parts	32

6 Compliance with EC Directives 33

6.1 Compliance with the EMC Directive 33

6.2 Compliance with the Low Voltage Directive 34

7 Compliance with UL/cUL Standards 35

Revision History. 36

1 Confirmations Upon Delivery

Please confirm the following items as soon as you receive the product.

Item	Confirmation Method
Have you received the correct product as ordered?	Check the model number on the nameplate on the side of the product. Check all accessories as well.
Is the product damaged in any way?	Check the appearance of the entire product for any damage that might have occurred during shipment.

If you find any problems with the above items, contact the place of purchase or your Yaskawa representative immediately.

1.1 Nameplate

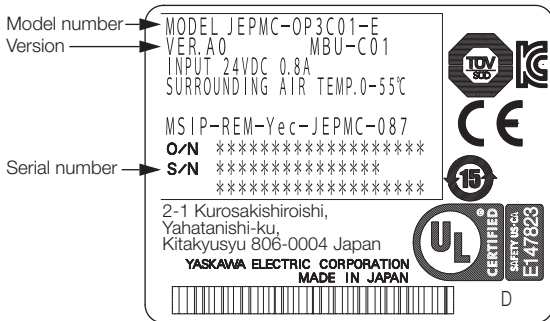

Interpreting Manufacturing Year and Month

The manufacturing year and month are given as part of the serial number.

S/N D 0 1 4 3 H 0 9 5 6 1 0 0 0 4

3rd+4th
digits

5th digit

3rd+4th
digits

Manufacturing Year

The last two digits of the manufacturing year are given.

Example

15: 2015

16: 2016

5th digit

Manufacturing Month

The manufacturing month is given using the codes listed in the following table.

Code	Manufacturing Month
1	January
2	February
3	March
4	April
5	May
6	June
7	July
8	August
9	September
X	October
Y	November
Z	December

2 Specifications

2.1 Installation and Operating Conditions

The installation and operating conditions for the Option Base Unit are given in the following table.

Item		Specification
Environmental Conditions	Surrounding Air Temperature	0°C to 55°C
	Storage Temperature	-25°C to 85°C
	Surrounding Air Humidity	10% to 95% relative humidity (with no condensation)
	Storage Humidity	10% to 95% relative humidity (with no condensation)
	Degree of Protection	IP20
	Pollution Degree	2 <ul style="list-style-type: none"> • Must be no corrosive or flammable gases. • Must be no exposure to water, oil, or chemicals. • Must be no dust, salts, or iron dust.
	Corrosive Gas	There must be no combustible or corrosive gas.
	Operating Altitude	2,000 m max.
Mechanical Operating Conditions	Vibration Resistance	4.9 m/s ²
	Shock Resistance	19.6 m/s ²
Electrical Operating Conditions	Noise Resistance	Conforms to EN 61000-6-2, EN 61000-6-4, EN 61800-3, and EN 55011 (Group 1, Class A). Power supply noise (FT noise): ±2 kV min. for one minute Radiation noise (FT noise): ±1 kV min. for one minute Ground noise (impulse noise): ±1 kV min. for 10 minutes Electrostatic noise (contact discharge method): ±6 kV min. 10 times

Continued on next page.

Continued from previous page.

Item		Specification
Installation Conditions	Ground	Ground to 100 Ω max.
	Cooling Method	Natural cooling
Other Specifications		Do not use the SERVOPACK in the following locations: Locations subject to static electricity noise, strong electromagnetic/magnetic fields, or radioactivity.

2.2 Specifications

The specifications of the Option Base Unit are listed in the following table.

Item		Specification
Model		JEPMC-OP3C01-E
Number of Slots		1
Applicable Modules		MP2000-series Option Modules
Power Supply Section	Input Voltage	24 VDC
	Allowable Input Voltage Range	19.2 to 28.8 VDC
	Input Current	0.8 A (at rated input/output)
	Allowable Power Loss Time	1 ms
	Rated Voltage	5.15 V
	Rated Current	3.0 A
	Output Current Range	0 to 3.0 A
	Rated Voltage Accuracy	5.15 V \pm 2% max. (5.05 to 5.25 V)
Connectors		Power supply connector

2.3 Appearance and Part Names

The following figure shows the appearance of the Option Base Unit and a part name.

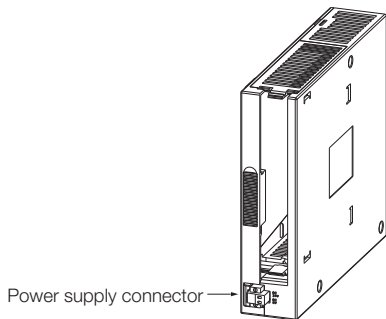

2.4 External Dimensions

The dimensions of the Option Base Unit are given in the following figure.

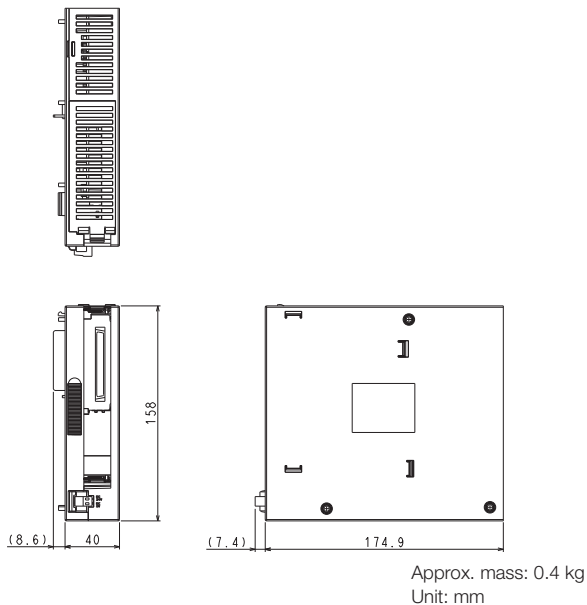

2.5 Option Modules

The following table lists Option Modules that can be mounted on the Base Unit.

Type	Abbreviation	Model Number	Description
Communications Modules	217IF-01	JAPMC-CM2310-E	RS-232C/RS-422 communications
	218IF-01	JAPMC-CM2300-E	RS-232C/Ethernet communications (10Base-T)
	218IF-02	JAPMC-CM2302-E	RS-232C/Ethernet communications (100Base-TX/10Base-T)
	260IF-01	JAPMC-CM2320-E	RS-232C/DeviceNet communications
	261IF-01	JAPMC-CM2330-E	RS-232C/PROFIBUS communications
	262IF-01	JAPMC-CM2303-E	FL-net communications
	263IF-01	JAPMC-CM2304-E	EtherNet/IP communications
	264IF-01	JAPMC-CM2305-E	EtherCAT (EtherCAT slave)
	265IF-01	JAPMC-CM2390-E	CompoNet (I/O communications and message communications)
	266IF-01	JAPMC-CM2306-E	PROFINET (PROFINET master)
	266IF-02	JAPMC-CM2307-E	PROFINET (PROFINET slave)
	267IF-01	JAPMC-CM23A0-E	CC-Link (CC-Link master)
	AFMP-01	-	Anywire-Master DB by Anywire Corporation
	AFMP-02-C	-	CC-Link by Anywire Corporation
	AFMP-02-CA	-	CC-Link and Anywire-Master DB by Anywire Corporation

Continued on next page.

Continued from previous page.

Type	Abbreviation	Model Number	Description
Communi- cations Modules	MPANL00-0	-	A-net/A-Link by ALGO System
	MPALL00-0	-	A-Link/ALink by Algo System
	MPAL000-0	-	A-Link by ALGO System
	MPAN000-0	-	A-net by ALGO System
	MPCUNET-0	-	CUnet by Algo System
	MPHLS-01	-	HLS by M-System Co., Ltd.
I/O Modules	LIO-01	JAPMC- IO2300-E	16 inputs, 16 sink outputs, 1 pulse-train input
	LIO-02	JAPMC- IO2301-E	16 inputs, 16 source outputs, 1 pulse-train input
	LIO-04	JAPMC- IO2303-E	32 inputs, 32 sink outputs
	LIO-05	JAPMC- IO2304-E	32 inputs, 32 source outputs
	LIO-06	JAPMC- IO2305-E	8 digital inputs, 8 digital sink outputs 1 analog input channel and 1 analog output channel 1 pulse-train counter channel
	DO-01	JAPMC- DO2300-E	64 sink outputs
	AI-01	JAPMC- AN2300-E	8 analog input channels
	AO-01	JAPMC- AN2310-E	4 analog output channels
	CNTR-01	JAPMC- PL2300-E	2 counter channels, selection of 2 input circuits: 5-V differential or 12 V

3 Installation

3.1 Precautions for the Installation Location

Precautions for the installation location are given in the following table.

Installation Condition	Installation Precautions
Installation in a control panel	<ul style="list-style-type: none"> • Design the control panel size, product location, and cooling method so that the ambient temperature around the product does not exceed 55°C. • If you install products side by side, install a cooling fan above them. • Provide gaps above and below the product.
Installation near heat-generating objects	<p>Suppress temperature increases due to radiant heat or convection from the heat-generating object so that the ambient temperature around the product does not exceed 55°C.</p>
Installation near sources of vibration	<p>Install a vibration-absorbing device on the installation surface for the product to prevent vibration from reaching the product.</p>
Installation in locations subject to corrosive gas	<p>Take measures to prevent corrosive gas from entering the product. Although the product would not be affected immediately, the product or contact devices may fail in the future if exposed to corrosive gas.</p>
Others	<ul style="list-style-type: none"> • Do not install the product in locations that are subject to high temperatures or high humidity, or subject to excessive amounts of dust, dirt, or iron powder. • Do not subject the product to freezing or condensation. • For long-term reliability, use the product at an ambient temperature of 45°C or less.

3.2 Mounting Interval

Installing One SERVOPACK in a Control Panel

Provide the following spaces around the SERVOPACK.

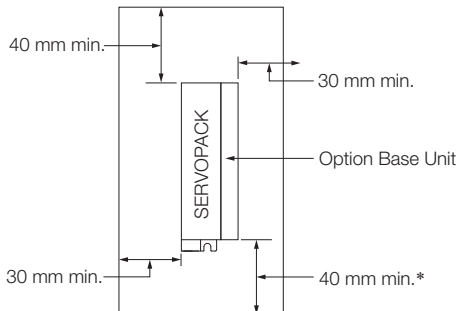

* For this dimension, ignore items protruding from the main body of the SERVOPACK.

Installing More Than One SERVOPACK in a Control Panel

Provide the following intervals between the SERVOPACKs and spaces around the SERVOPACKs.



Install cooling fans above the SERVOPACKs so that hot spots do not occur around the SERVOPACKs. Provide sufficient intervals and spaces as shown in the following figure to enable cooling by the fans and natural convection.

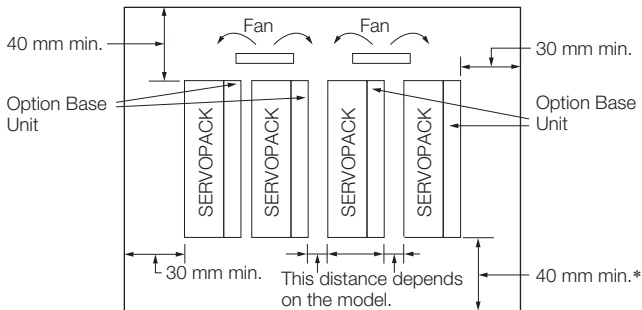

* For this dimension, ignore items protruding from the main body of the SERVOPACK.

The space required on the right side of a SERVOPACK (when looking at the SERVOPACK from the front) depends on the SERVOPACK models. Refer to the following table.

SERVOPACK Model	Space on Right Side	Cooling Fan Installation Conditions
		10 mm above SERVOPACK's Top Surface
SGD7C	5 mm min.	Air speed: 1.0 m/s min.

3.3 Connecting an Option Base Unit

Use the following procedure to connect an Option Base Unit.

1. Remove the connector covers from the SERVOPACK and the Option Base Unit.

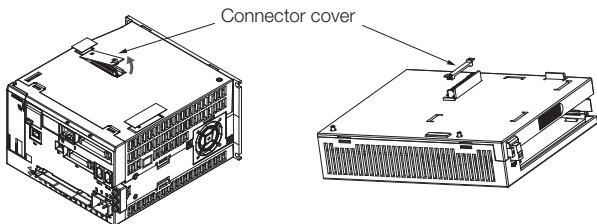

2. Remove the two insulating seals from the SERVOPACK.

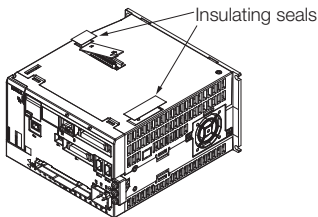

3. Hold the Option Base Unit on both sides and securely insert the connector on it into the connector on the SERVOPACK.
4. Secure the Option Base Unit with three screws.
(Tightening torque: 0.49 N·m)

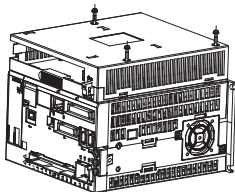

3.4 Installing an Option Module

Use the following procedure to install an Option Module.

1. Hold the top and bottom of the Option Module to be installed, line up the Module with the left side of the guide rail inside the option slot, and then insert the Module straight in.

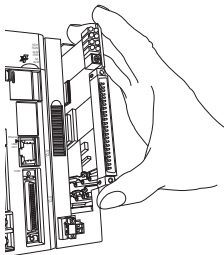

2. After the Option Module is completely inserted, place your hand on the front of the Option Module and press the Option Module firmly until it mates with the Mounting Base connectors in the Unit. The front of the Option Module and the tabs will be aligned if the Option Module has been installed properly.
3. Place the hole on the bottom of the panel of the Option Module onto the tab on the bottom of the Unit. Next, hook the hole at the top of the panel of the Option Module onto the tab on the Unit.

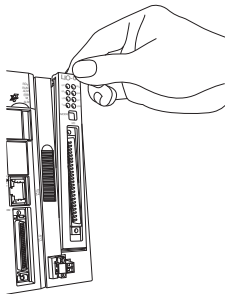

This completes the installation procedure.

3.5 Replacing an Option Module

Use the following procedure to replace an Option Module.



Always create a backup before replacing an Option Module. Back up the program from the SEVOPACK to the PC using the MPE720.

1. Turn OFF the power supply and disconnect all cables from the SEVOPACK.
2. Remove the tool from the Option Base Unit.

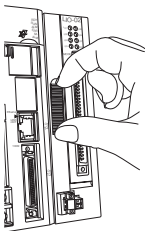

3. Insert the protruding part of the tool into the slot on top of the Option Module panel to unhook the tab.

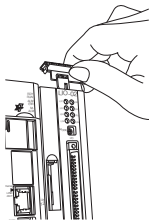

Unhook the bottom tab in the same way.

3 Installation

4. Pull the top of the Option Module panel toward you and remove it. A notch on the Option Module will be visible from the gap of the panel. Hook the round knob on the tool into the notch in the Option Module.

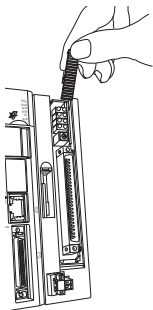

5. Hold the center of the tool, and turn it around the round knob while pushing it toward the back to disconnect the Module from the Mounting Base connectors. Then, pull the Module forward.



6. Hold the Option Module at the top and bottom and pull it straight out. Hold the edges of the Module and avoid touching the components on the Module.

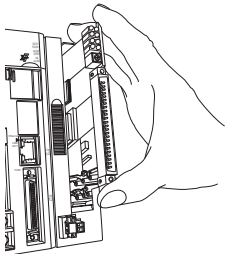

Note: Put the Module that you removed into the bag that was supplied when you purchased it and store the Module in this bag.

7. Install the Option Module that you want to use.
 [3.4 Installing an Option Module on page 24](#)

4 Wiring

4.1 Power Supply Connector



Type	Model	Manufacturer
Terminal block connector with screw connections	BL3.5/2F-AU	Weidmüller Interface GmbH & Co. KG

Pin Assignments

Signal name	Description
24 VDC	Power input wire for 24 VDC
0 VDC	Power input wire for 0 VDC

4.2 Connection Method

Use the following procedure to connect the 24-VDC power supply to the power supply connector.

1. Prepare an AWG24 to AWG20 (0.2 mm^2 to 0.51 mm^2) twisted-pair cable.
2. Remove the sheath for approximately 6.5 mm from the end of the cable.

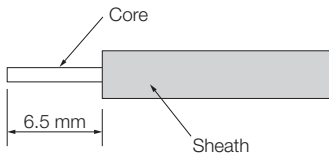

3. Remove the plug from the power supply connector.

4. Insert the cores of the cable all the way into the openings in the plug and then tighten the screws to a tightening torque of approximately 0.2 to 0.25 N-m.

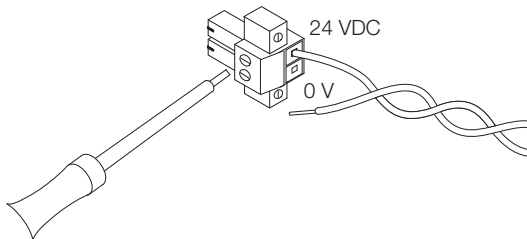

5. Connect the wires as shown in the following diagram.

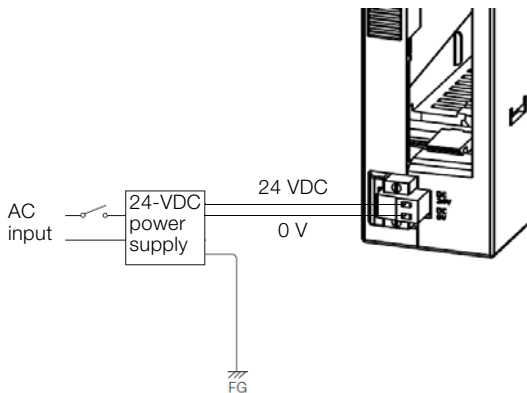

Important

- For a 24-VDC power supply, use a power supply device with double insulation or reinforced insulation.
- Turn ON the 24-V power supply either simultaneously with or after you turn ON the control power supply to the SERVOPACK.
- Do not turn the 24-V power supply to the Option Base Unit and the control power supply to the SERVOPACK OFF and ON again separately.

5 Inspections

Perform inspections and part replacements according to the information that is provided in this section.

5.1 Daily Inspections

The daily inspection items are given in the following table.

Inspection Item		Description	Criteria	Correction
Installation condition		Loose screws or covers	All screws and covers must be secure.	Tighten the screws.
Connection conditions		Loose terminal screws	Screws must not be loose.	Tighten the terminal screws.
		Connectors	Connectors must not be loose.	Tighten the lock screws on the connectors.
		Separation between crimped terminals	Suitable gaps must be maintained.	Correct the gaps.
Indicators	POWER indicator	Check the status when power is ON.	Must be lit. (Otherwise, there is an error.)	Refer to the relevant manual.*

*  Σ -7-Series AC Servo Drive Σ -7C SERVOPACK Product Manual (Manual No.: SIEP S800002 04)

5.2 Periodic Inspections

Perform the following inspections at least once a year.

Inspection Item		Inspection Period	Description	Correction
Ambient conditions	Ambient temperature*	At least 1 or 2 times every 6 to 12 months	Measure the temperature and humidity with a hydrometer and thermometer and measure corrosive gas. They must be within specifications.	Remove sources of contamination or improve the installation environment.
	Ambient humidity			
	Atmosphere			
Visual exterior inspection		At least 1 time a year	There must be no dirt, dust, oil, or other foreign matter on the product.	Clean the product with air or a cloth.
Loose screws			There must be no looseness in terminal screws or connector lock screws.	Tighten the screws.

* If the product is installed in a panel, the temperature inside the panel is the ambient temperature.

5.3 Replacement Guidelines for Product Parts

Electrical and electronic parts have a limited service life due to mechanical wear and deterioration over time. Perform periodic inspections for preventive maintenance.

Contact your Yaskawa representative for replacements based on the standard replacement periods that are given in the following table. Yaskawa will inspect your product and determine if part replacement is required.

Part Name	Standard Replacement Period	Application Conditions
Aluminum electrolytic capacitors on PCBs	10 years	Ambient temperature: 40°C or less

6 Compliance with EC Directives

6.1 Compliance with the EMC Directive

This section gives the installation conditions that were used for EMC certification testing.

The EMC installation conditions that are given here are the conditions that were used to pass testing criteria at Yaskawa. The EMC level may change under other conditions, such as the actual installation structure and wiring conditions. These Yaskawa products are designed to be built into equipment. Therefore, you must implement EMC measures and confirm compliance for the final equipment.

The applicable standards are EN 55011 group 1 class A, EN 61000-6-2, EN 61000-6-4, and EN 61800-3 (category C2, second environment).

- Three-Phase, 200 VAC

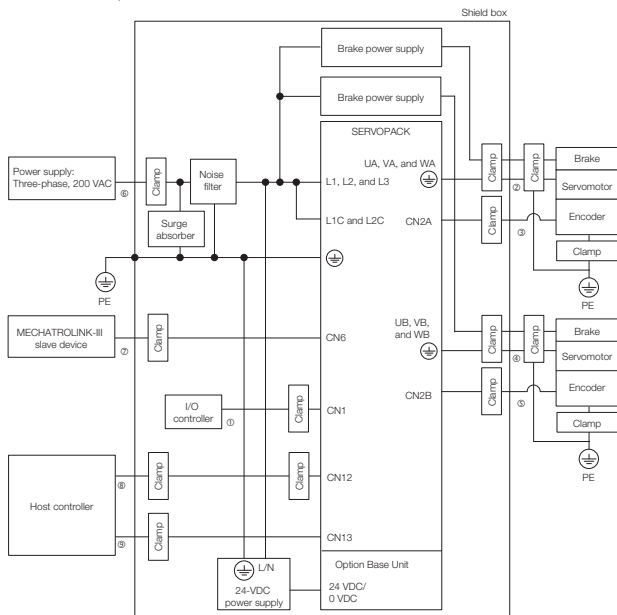

6 Compliance with EC Directives

Symbol	Cable Name	Specification
①	I/O Signal Cable (CN1)	Shielded cable
②	Motor Main Circuit Cable for axis A	Shielded cable
③	Encoder Cable for axis A	Shielded cable
④	Motor Main Circuit Cable for axis B	Shielded cable
⑤	Encoder Cable for axis B	Shielded cable
⑥	Main Circuit Power Cable	Shielded cable
⑦	MECHATROLINK-III Communications Cable	Shielded cable
⑧	Ethernet cable	Shielded cable
⑨	I/O Signal Cable (CN13)	Shielded cable

6.2 Compliance with the Low Voltage Directive

The product complies with the following Low Voltage Directives: EN61800-5-1, EN50178.

7 Compliance with UL/cUL Standards

The product complies with the following UL standards.

- UL: UL 61800-5-1 (E147823)
- cUL: CSA C22.2 No.274

UL Certification Mark:



File No.: E147823

Revision History

The revision dates and numbers of the revised manuals are given on the bottom of the back cover.

MANUAL NO. TOMP C880725 26A <1>-0
Published in Japan November 2016

WEB revision number
Revision number
Date of publication

Date of Publication	Rev. No.	WEB. Rev. No.	Section	Revised Contents
November 2016	<1>	0	Last page of the manual	Addition: Information on hazardous substances in controllers
May 2016	-	-	-	First edition

Σ-7-Series AC Servo Drive Option Base Unit INSTRUCTIONS

IRUMA BUSINESS CENTER (SOLUTION CENTER)

480, Kamifujsawa, Iruma, Saitama, 358-8555, Japan
Phone 81-4-2962-5151 Fax 81-4-2962-6138
<http://www.yaskawa.co.jp>

YASKAWA AMERICA, INC.

2121, Norman Drive South, Waukegan, IL 60085, U.S.A.
Phone 1-800-YASKAWA (927-5292) or 1-847-887-7000 Fax 1-847-887-7310
<http://www.yaskawa.com>

YASKAWA ELÉTRICO DO BRASIL LTDA.

777, Avenida Piraporinha, Diadema, São Paulo, 09950-000, Brasil
Phone 55-11-3585-1100 Fax 55-11-3585-1187
<http://www.yaskawa.com.br>

YASKAWA EUROPE GmbH

185, Hauptstraße, Eschborn, 65760, Germany
Phone 49-6196-569-300 Fax 49-6196-569-398
<http://www.yaskawa.eu.com>

YASKAWA ELECTRIC KOREA CORPORATION

9F, Kyobo Securities Bldg. 26-4, Yeouido-dong, Yeongdeungpo-gu, Seoul, 150-737, Korea
Phone 82-2-784-7844 Fax 82-2-784-8495
<http://www.yaskawa.co.kr>

YASKAWA ELECTRIC (SINGAPORE) PTE. LTD.

151, Lorong Chuan, #04-02A, New Tech Park, 556741, Singapore
Phone 65-6282-3003 Fax 65-6289-3003
<http://www.yaskawa.com.sg>

YASKAWA ELECTRIC (THAILAND) CO., LTD.

59, 1st-5th Floor, Flourish Building, Soi Ratchadapisek 18, Ratchadapisek Road, Huaykwang, Bangkok, 10310, Thailand
Phone 66-2-017-0099 Fax 66-2-017-0799
<http://www.yaskawa.co.th>

YASKAWA ELECTRIC (CHINA) CO., LTD.

22F, One Corporate Avenue, No.222, Hubin Road, Shanghai, 200021, China
Phone 86-21-5385-2200 Fax 86-21-5385-3299
<http://www.yaskawa.com.cn>

YASKAWA ELECTRIC (CHINA) CO., LTD. BEIJING OFFICE

Room 1011, Tower W3 Oriental Plaza, No.1, East Chang An Ave.,
Dong Cheng District, Beijing, 100738, China
Phone 86-10-8518-4086 Fax 86-10-8518-4082

YASKAWA ELECTRIC TAIWAN CORPORATION

9F, 16, Nanking E. Rd., Sec. 3, Taipei, 104, Taiwan
Phone 886-2-2502-5003 Fax 886-2-2505-1280

YASKAWA

YASKAWA ELECTRIC CORPORATION

In the event that the end user of this product is to be the military and said product is to be employed in any weapons systems or the manufacture thereof, the export will fall under the relevant regulations as stipulated in the Foreign Exchange and Foreign Trade Regulations. Therefore, be sure to follow all procedures and submit all relevant documentation according to any and all rules, regulations and laws that may apply. Specifications are subject to change without notice for ongoing product modifications and improvements.
© 2016 YASKAWA ELECTRIC CORPORATION

MANUAL NO. TOMP C880725 26A <1>-0
Published in Japan November 2016
15-8-11
Original instructions

控制器中含有有害物质的信息

コントローラの有害物質含有情報

Information on hazardous substances in controllers

本资料根据中国《电器电子产品有害物质限制使用管理办法》制定。

本資料は、中国「電器電子製品有害物質使用制限管理弁法」に基づいて記載しています。

This is based on the “Management Methods for the Restriction of the Use of Hazardous Substances in Electrical and Electronic Products.”

产品中有害物质的名称及含量
製品中の有害物質名称及び含有量
Contents of hazardous substances in products

部件名称 部位名称 Parts Name	有害物质 有害物質 Hazardous substances					
	铅 鉛 Lead (Pb)	汞 水銀 Mercury (Hg)	镉 カドミ ウム Cadmium (Cd)	六价铬 6価クロム Hexavalent chromium (Cr VI)	多溴联苯 ポリ臭化 ビフェニル Polybromina ted biphenyls (PBB)	多溴二苯醚 ポリ臭化 ジフェニル エーテル Polybrominated diphenyl ethers (PBDE)
实装 基板 実装 基板 Circuit Board	×	○	○	○	○	○
外壳 ケース Case	○	○	○	○	○	○

本表格依据 SJ/T 11364 的规定编制。

本表は SJ/T 11364 の規定により作成したものです。

This table has been prepared in accordance with the provisions outlined in SJ/T11364.

○：表示该有害物质在该部件所有均质材料中的含量均在 GB/T 26572 规定的限量要求以下。

×：表示该有害物质至少在该部件的某一均质材料中的含量超出 GB/T 26572 规定的限量要求。

- ：該当部品全ての均質材料による有害物質の含有量が GB/T 26572 に定める限度量の要求以下であることを示します。
- ×：該当部品中の少なくとも1種類の均質材料における当該有害物質の含有量が、GB/T 26572 に定める限度量を上回っていることを示します。
- ： Indicates that said hazardous substance contained in all of the homogeneous materials for this part is below or equal to the limit requirement of GB/T 26572.
- ×： Indicates that said hazardous substance contained in at least one of the homogeneous materials used for this part is above the limit requirement of GB/T 26572.

注：本產品符合歐洲的 RoHS 指令。

上表中的“×”表示含有歐盟 RoHS 指令豁免的有害物質。

注記：本製品は欧州の RoHS 指令に適合しています。

上記表の“×”は、欧州 RoHS 指令の適用除外である有害物質を含むことを示します。

Note : This product complies with EU RoHS directives.

In the above table, “×” indicates that hazardous substances that are exempt from EU RoHS directives are contained.