

Σ -7-Series AC Servo Drive

Σ -7S SERVOPACK with FT/EX Specification for Tracking Application Product Manual

Model: SGD7S-□□□A00□□□□F19□, -□□□A20□□□□F19□

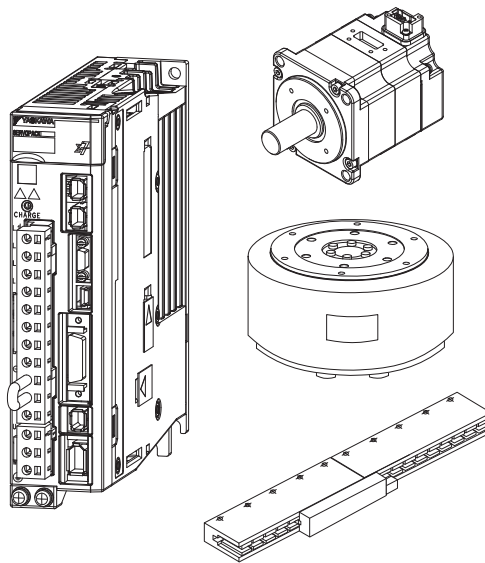

Basic Information on SERVOPACKs	1
SERVOPACK Ratings and Specifications	2
Less-Deviation Control	3
Maintenance	4
Parameter Lists	5

Copyright © 2015 YASKAWA ELECTRIC CORPORATION

All rights reserved. No part of this publication may be reproduced, stored in a retrieval system, or transmitted, in any form, or by any means, mechanical, electronic, photocopying, recording, or otherwise, without the prior written permission of Yaskawa. No patent liability is assumed with respect to the use of the information contained herein. Moreover, because Yaskawa is constantly striving to improve its high-quality products, the information contained in this manual is subject to change without notice. Every precaution has been taken in the preparation of this manual. Nevertheless, Yaskawa assumes no responsibility for errors or omissions. Neither is any liability assumed for damages resulting from the use of the information contained in this publication.

About this Manual

This manual describes the tracking application option for Σ -7-Series AC Servo Drive Σ -7S SERVOPACKs.

Read and understand this manual to ensure correct usage of the Σ -7-Series AC Servo Drives.

Keep this manual in a safe place so that it can be referred to whenever necessary.

Outline of Manual

The contents of the chapters of this manual are described in the following table.

When you use the SERVOPACK, read this manual and the relevant product manual given in the following table.

Item	This Manual	Σ -7-Series AC Servo Drive Σ -7S SERVOPACK Product Manual	
		SERVOPACKs with Analog Voltage/Pulse Train References (Manual No.: SIEP S800001 26)	SERVOPACKs with MECHATROLINK-III Communications References (Manual No.: SIEP S800001 28)
Basic Information on SERVOPACKs	The Σ -V Series	–	1.1
	Product Introduction	1.1	–
	Interpreting the Nameplates	–	1.2
	Part Names	–	1.3
	Model Designations	–	1.4
	Combinations of SERVOPACKs and Servomotors	–	1.5
	Functions	1.4	–
	SigmaWin+	1.5	–
Selecting a SERVOPACK	Ratings	2.1	–
	SERVOPACK Overload Protection Characteristics	2.2	–
	Specifications	2.3	–
	Block Diagrams	–	2.2
	External Dimensions	–	2.3
	Examples of Standard Connections between SERVOPACKs and Peripheral Devices	–	2.4
SERVOPACK Installation	–		Chapter 3
Wiring and Connecting SERVOPACKs	–		Chapter 4
Basic Functions That Require Setting before Operation	–		Chapter 5
Application Functions	–		Chapter 6
Trial Operation and Actual Operation	–		Chapter 7
Tuning	–		Chapter 8

Continued on next page.

Continued from previous page.

Item		This Manual	Σ-7-Series AC Servo Drive Σ-7S SERVOPACK Product Manual	
			SERVOPACKs with Analog Voltage/Pulse Train References (Manual No.: SIEP S800001 26)	SERVOPACKs with MECHATROLINK-III Communications References (Manual No.: SIEP S800001 28)
Monitoring	Monitoring Product Information	–	9.1	
	Monitoring SERVO-PACK Status	–	9.2	
	Monitoring Machine Operation Status and Signal Waveforms	3.6	–	
	Monitoring Product Life	–	9.4	
Fully-Closed Loop Control		–	Chapter 10	
Safety Functions		–	Chapter 11	
Less-Deviation Control	Introduction	3.1	–	
	Restrictions	3.2	–	
	Adjusting Less-Deviation Control 2	3.3	–	
	Adjusting Less-Deviation Control 1	3.4	–	
	Reference Compensation	3.5	–	
Maintenance	Inspections and Part Replacement	–	12.1	
	Alarm Displays	4.1.1, 4.2.1	–	
	List of Alarms	4.1.2, 4.2.2	–	
	Troubleshooting Alarms	4.1.3, 4.2.3	–	
	Warning Displays	4.1.4, 4.2.4	–	
	List of Warnings	4.1.5, 4.2.5	–	
	Troubleshooting Warnings	4.1.6, 4.2.6	–	
Panel Displays and Panel Operator Procedures		–	Chapter 13	–
Parameter Lists	Interpreting the Parameter Lists	5.1.1, 5.2.1	–	
	List of Parameters and List of Servo Parameters	5.1.2, 5.2.2	–	
	List of MECHATROLINK-III Common Parameters	5.2.3	–	
	Parameter Recording Table	5.1.3, 5.2.4	–	
Appendices		–	Chapter 15	Chapter 14

Related Documents

The relationships between the documents that are related to the Servo Drives are shown in the following figure. The numbers in the figure correspond to the numbers in the table on the following pages. Refer to these documents as required.

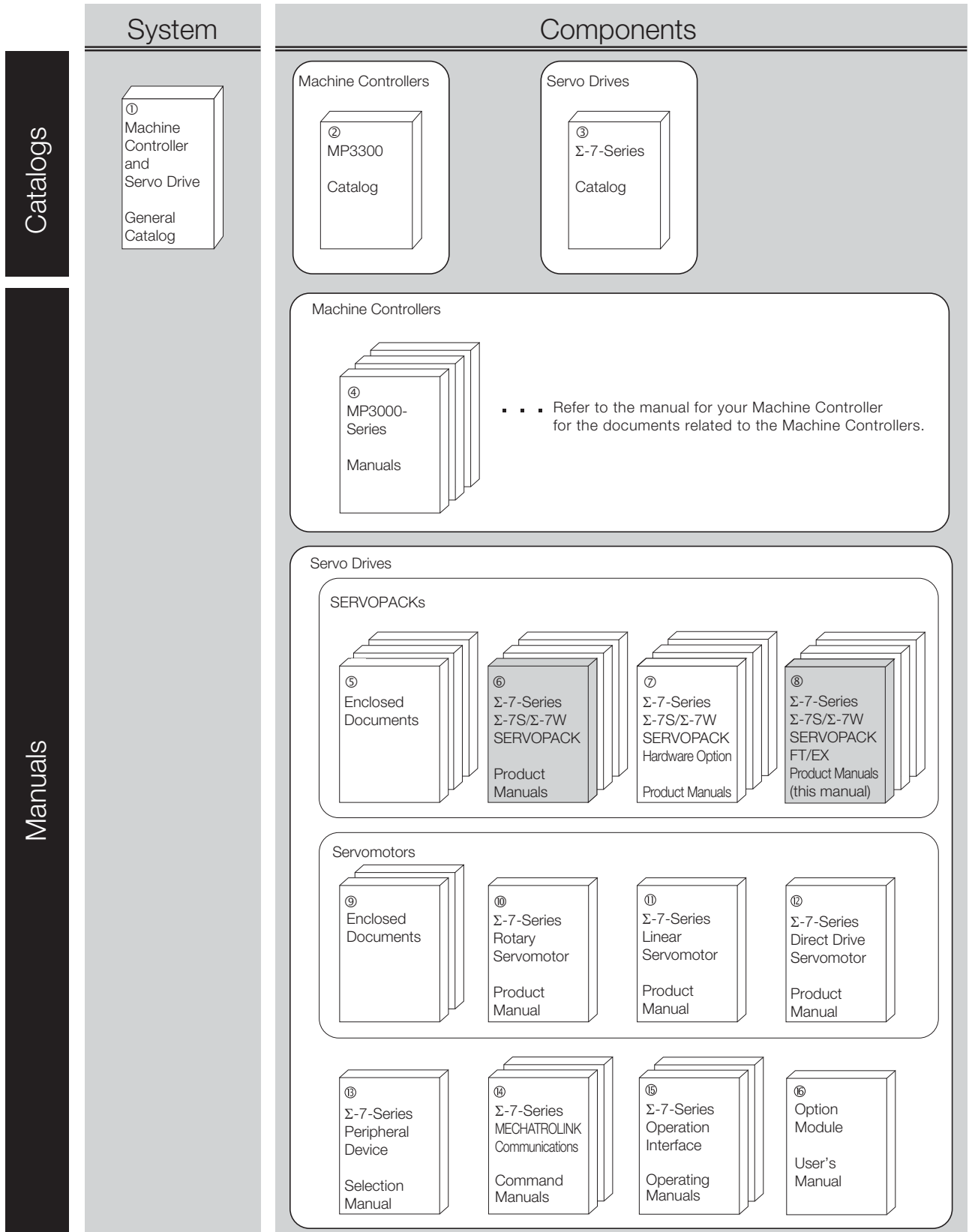

Classification	Document Name	Document No.	Description
① Machine Controller and Servo Drive General Catalog	Machine Controller and AC Servo Drive Solutions Catalog	KAEP S800001 22	Describes the features and application examples for combinations of MP3000-Series Machine Controllers and Σ -7-Series AC Servo Drives.
② MP3300 Catalog	Machine Controller MP3300	KAEP C880725 03	Provides detailed information on MP3300 Machine Controllers, including features and specifications.
③ Σ -7-Series Catalog	AC Servo Drives Σ -7 Series	KAEP S800001 23	Provides detailed information on Σ -7-Series AC Servo Drives, including features and specifications.
④ MP3000-Series Manuals	Machine Controller MP3000 Series MP3300 Product Manual	SIEP C880725 21	Describes the functions, specifications, operating methods, maintenance, inspections, and troubleshooting of the MP3000-series MP3300 Machine Controllers.
⑤ Enclosed Documents	Σ -7-Series AC Servo Drive Σ -7S and Σ -7W SERVOPACK Safety Precautions	TOMP C710828 00	Provides detailed information for the safe usage of Σ -7-Series SERVOPACKs.
	Σ -V Series/ Σ -V Series for Large-Capacity Models/ Σ -7 Series Safety Precautions Option Module	TOBP C720829 00	Provides detailed information for the safe usage of Option Modules.
	Σ -V Series/ Σ -V Series for Large-Capacity Models/ Σ -7 Series Installation Guide Command Option Module	TOBP C720829 01	Provides detailed procedures for installing a Command Option Module in a SERVOPACK.
	Σ -V Series/ Σ -V Series for Large-Capacity Models/ Σ -7 Series Installation Guide Fully-closed Module	TOBP C720829 03	Provides detailed procedures for installing the Fully-closed Module in a SERVOPACK.
	Σ -V Series/ Σ -V Series for Large-Capacity Models/ Σ -7 Series Installation Guide Safety Module	TOBP C720829 06	Provides detailed procedures for installing the Safety Module in a SERVOPACK.
	Σ -V Series/ Σ -V Series for Large-Capacity Models/ Σ -7 Series Installation Guide Indexer Module	TOBP C720829 02	Provides detailed procedures for installing the Indexer Module in a SERVOPACK.
	Σ -V Series/ Σ -V Series for Large-Capacity Models/ Σ -7 Series Installation Guide DeviceNet Module	TOBP C720829 07	Provides detailed procedures for installing the DeviceNet Module in a SERVOPACK.

Continued on next page.

Continued from previous page.

Classification	Document Name	Document No.	Description
⑥ Σ-7-Series Σ-7S/Σ-7W SERVOPACK Product Manuals	Σ-7-Series AC Servo Drive Σ-7S SERVOPACK with MECHATROLINK-III Communications References Product Manual	SIEP S800001 28	Provide detailed information on selecting Σ-7-Series SERVO-PACKS and information on installing, connecting, setting, performing trial operation for, tuning, and monitoring the Servo Drives.
	Σ-7-Series AC Servo Drive Σ-7S SERVOPACK with MECHATROLINK-II Communications References Product Manual	SIEP S800001 27	
	Σ-7-Series AC Servo Drive Σ-7S SERVOPACK with Analog Voltage/Pulse Train References Product Manual	SIEP S800001 26	
	Σ-7-Series AC Servo Drive Σ-7S SERVOPACK Command Option Attachable Type with Indexer Module Product Manual	SIEP S800001 64	
	Σ-7-Series AC Servo Drive Σ-7S SERVOPACK Command Option Attachable Type with DeviceNet Module Product Manual	SIEP S800001 70	
	Σ-7-Series AC Servo Drive Σ-7W SERVOPACK with MECHATROLINK-III Communications References Product Manual	SIEP S800001 29	
⑦ Σ-7-Series Σ-7S/Σ-7W SERVOPACK with Hardware Option Specifications Product Manuals	Σ-7-Series AC Servo Drive Σ-7S/Σ-7W SERVOPACK with Hardware Option Specifications Dynamic Brake Product Manual	SIEP S800001 73	Provides detailed information on Hardware Options for Σ-7-Series SERVOPACKs.
	Σ-7-Series AC Servo Drive Σ-7W SERVOPACK with Hardware Option Specifications HWBB Function Product Manual	SIEP S800001 72	
⑧ Σ-7-Series Σ-7S/Σ-7W SERVOPACK FT/EX Specification Product Manuals	Σ-7-Series AC Servo Drive Σ-7S SERVOPACK with FT/EX Specification for Tracking Application Product Manual	This manual (SIEP S800001 89)	Provides detailed information on the FT/EX Option for Σ-7-Series SERVOPACKs.
⑨ Enclosed Documents	AC Servo Drive Rotary Servomotor Safety Precautions	TOBP C230260 00	Provides detailed information for the safe usage of Rotary Servomotors and Direct Drive Servomotors.
	AC Servomotor Linear Σ Series Safety Precautions	TOBP C230800 00	Provides detailed information for the safe usage of Linear Servomotors.

Continued on next page.

Continued from previous page.

Classification	Document Name	Document No.	Description
⑩ Σ-7-Series Rotary Servomotor Product Manual	Σ-7-Series AC Servo Drive Rotary Servomotor Product Manual	SIEP S800001 36	Provide detailed information on selecting, installing, and connecting the Σ-7-Series Servomotors.
⑪ Σ-7-Series Linear Servomotor Product Manual	Σ-7-Series AC Servo Drive Linear Servomotor Product Manual	SIEP S800001 37	
⑫ Σ-7-Series Direct Drive Servomotor Product Manual	Σ-7-Series AC Servo Drive Direct Drive Servomotor Product Manual	SIEP S800001 38	
⑬ Σ-7-Series Peripheral Device Selection Manual	Σ-7-Series AC Servo Drive Peripheral Device Selection Manual	SIEP S800001 32	Describes the peripheral devices for a Σ-7-Series Servo System.
⑭ Σ-7-Series MECHATROLINK Communications Command Manuals	Σ-7-Series AC Servo Drive MECHATROLINK-II Communications Command Manual	SIEP S800001 30	Provides detailed information on the MECHATROLINK-II communications commands that are used for a Σ-7-Series Servo System.
	Σ-7-Series AC Servo Drive MECHATROLINK-III Communications Standard Servo Profile Command Manual	SIEP S800001 31	Provides detailed information on the MECHATROLINK-III communications standard servo profile commands that are used for a Σ-7-Series Servo System.
⑮ Σ-7-Series Operation Interface Operating Manuals	Σ-7-Series AC Servo Drive Digital Operator Operating Manual	SIEP S800001 33	Describes the operating procedures for a Digital Operator for a Σ-7-Series Servo System.
	AC Servo Drive Engineering Tool SigmaWin+ Operation Manual	SIEP S800001 34	Provides detailed operating procedures for the SigmaWin+ Engineering Tool for a Σ-7-Series Servo System.
⑯ Option Module User's Manual	Σ-V-Series/Σ-V-Series for Large-Capacity Models/ Σ-7-Series User's Manual Safety Module	SIEP C720829 06	Provides details information required for the design and maintenance of a Safety Module.

Using This Manual

◆ Technical Terms Used in This Manual

The following terms are used in this manual.

Term	Meaning
Servomotor	A Σ -7-Series Rotary Servomotor, Direct Drive Servomotor, or Linear Servomotor.
Rotary Servomotor	A generic term used for a Σ -7-Series Rotary Servomotor (SGM7A, SGM7J, or SGM7G) or a Direct Drive Servomotor (SGMCS or SGMCV). The descriptions will specify when Direct Drive Servomotors are excluded.
Linear Servomotor	A Σ -7-Series Linear Servomotor (SGLG, SGLF, SGLT, or SGLC).
SERVOPACK	A Σ -7-Series Σ -7S Servo Amplifier with Analog Voltage/Pulse Train References or MECHATROLINK-III Communications References
Servo Drive	The combination of a Servomotor and SERVOPACK.
Servo System	A servo control system that includes the combination of a Servo Drive with a host controller and peripheral devices.
servo ON	Supplying power to the motor.
servo OFF	Not supplying power to the motor.
base block (BB)	Shutting OFF the power supply to the motor by shutting OFF the base current to the power transistor in the SERVOPACK.
servo lock	A state in which the motor is stopped and is in a position loop with a position reference of 0.
Main Circuit Cable	One of the cables that connect to the main circuit terminals, including the Main Circuit Power Supply Cable, Control Power Supply Cable, and Servomotor Main Circuit Cable.
SigmaWin+	The Engineering Tool for setting up and tuning Servo Drives or a computer in which the Engineering Tool is installed.

◆ Differences in Terms for Rotary Servomotors and Linear Servomotors

There are differences in the terms that are used for Rotary Servomotors and Linear Servomotors. This manual primarily describes Rotary Servomotors. If you are using a Linear Servomotor, you need to interpret the terms as given in the following table.

Rotary Servomotors	Linear Servomotors
torque	force
moment of inertia	mass
rotation	movement
forward rotation and reverse rotation	forward movement and reverse movement
CW and CCW pulse trains	forward and reverse pulse trains
rotary encoder	linear encoder
absolute rotary encoder	absolute linear encoder
incremental rotary encoder	incremental linear encoder
unit: min^{-1}	unit: mm/s
unit: N·m	unit: N

◆ Notation Used in this Manual

■ Notation for Reverse Signals

The names of reverse signals (i.e., ones that are valid when low) are written with a forward slash (/) before the signal abbreviation.

Notation Example

\overline{BK} is written as /BK.

■ Notation for Parameters

The notation depends on whether the parameter requires a numeric setting (parameter for numeric setting) or requires the selection of a function (parameter for selecting functions).

• Parameters for Numeric Settings

The control methods for which the parameters apply are given.
Speed : Speed control Position : Position control Torque : Torque control

Pn100	Speed Loop Gain					Speed Position
	Setting Range	Setting Unit	Default Setting	When Enabled	Classification	
	10 to 20,000	0.1 Hz	400	Immediately	Tuning	

Parameter number: This is the setting range for the parameter.

This is the minimum unit (setting increment) that you can set for the parameter.

This is the parameter setting before shipment.

This is when any change made to the parameter will become effective.

This is the parameter classification.

• Parameters for Selecting Functions

Parameter	Meaning	When Enabled	Classification
Pn002	n.□□□□ (default setting)	After startup	Setup
	n.□1□□		
	n.□2□□		

Parameter number: The notation "n.□□□□" indicates a parameter for selecting functions. Each □ indicates the setting for one digit. The notation shown here means that the third digit from the right is set to 2.

This column explains the selections for the function.

Notation Example

Notation Examples for Pn002

n . 0 0 0 0	Digit Notation		Numeric Value Notation	
	Notation	Meaning	Notation	Meaning
→	Pn002 = n.□□□X	Indicates the first digit from the right in Pn002.	Pn002 = n.□□□1	Indicates that the first digit from the right in Pn002 is set to 1.
→	Pn002 = n.□□X□	Indicates the second digit from the right in Pn002.	Pn002 = n.□□1□	Indicates that the second digit from the right in Pn002 is set to 1.
→	Pn002 = n.□X□□	Indicates the third digit from the right in Pn002.	Pn002 = n.□1□□	Indicates that the third digit from the right in Pn002 is set to 1.
→	Pn002 = n.X□□□	Indicates the fourth digit from the right in Pn002.	Pn002 = n.1□□□	Indicates that the fourth digit from the right in Pn002 is set to 1.

◆ Engineering Tools Used in This Manual

This manual uses the interfaces of the SigmaWin+ for descriptions.

◆ Trademarks

- MECHATROLINK is a trademark of the MECHATROLINK Members Association.
- QR code is a trademark of Denso Wave Inc.
- Other product names and company names are the trademarks or registered trademarks of the respective company. “TM” and the ® mark do not appear with product or company names in this manual.

◆ Visual Aids

The following aids are used to indicate certain types of information for easier reference.



Indicates precautions or restrictions that must be observed.
Also indicates alarm displays and other precautions that will not result in machine damage.



Indicates definitions of difficult terms or terms that have not been previously explained in this manual.

Example Indicates operating or setting examples.

Information Indicates supplemental information to deepen understanding or useful information.

Safety Precautions

◆ Safety Information

To prevent personal injury and equipment damage in advance, the following signal words are used to indicate safety precautions in this document. The signal words are used to classify the hazards and the degree of damage or injury that may occur if a product is used incorrectly. Information marked as shown below is important for safety. Always read this information and heed the precautions that are provided.

DANGER

- Indicates precautions that, if not heeded, are likely to result in loss of life, serious injury, or fire.

WARNING

- Indicates precautions that, if not heeded, could result in loss of life, serious injury, or fire.

CAUTION

- Indicates precautions that, if not heeded, could result in relatively serious or minor injury, or in fire.

NOTICE

- Indicates precautions that, if not heeded, could result in property damage.

◆ Safety Precautions That Must Always Be Observed

■ General Precautions



DANGER

- Read and understand this manual to ensure the safe usage of the product.
- Keep this manual in a safe, convenient place so that it can be referred to whenever necessary. Make sure that it is delivered to the final user of the product.
- Do not remove covers, cables, connectors, or optional devices while power is being supplied to the SERVOPACK.
There is a risk of electric shock, operational failure of the product, or burning.



WARNING

- Use a power supply with specifications (number of phases, voltage, frequency, and AC/DC type) that are appropriate for the product.
There is a risk of burning, electric shock, or fire.
- Connect the ground terminals on the SERVOPACK and Servomotor to ground poles according to local electrical codes (100 Ω or less for a SERVOPACK with a 100-VAC or 200-VAC power supply, and 10 Ω or less for a SERVOPACK with a 400-VAC power supply).
There is a risk of electric shock or fire.
- Do not attempt to disassemble, repair, or modify the product.
There is a risk of fire or failure.
The warranty is void for the product if you disassemble, repair, or modify it.



CAUTION

- The SERVOPACK heat sinks, regenerative resistors, External Dynamic Brake Resistors, Servomotors, and other components can be very hot while power is ON or soon after the power is turned OFF. Implement safety measures, such as installing covers, so that hands and parts such as cables do not come into contact with hot components.
There is a risk of burn injury.
- For a 24-VDC power supply, use a power supply device with double insulation or reinforced insulation.
There is a risk of electric shock.
- Do not damage, pull on, apply excessive force to, place heavy objects on, or pinch cables.
There is a risk of failure, damage, or electric shock.
- The person who designs the system that uses the hard wire base block safety function must have a complete knowledge of the related safety standards and a complete understanding of the instructions in this document.
There is a risk of injury, product damage, or machine damage.
- Do not use the product in an environment that is subject to water, corrosive gases, or flammable gases, or near flammable materials.
There is a risk of electric shock or fire.

NOTICE

- Do not attempt to use a SERVOPACK or Servomotor that is damaged or that has missing parts.
- Install external emergency stop circuits that shut OFF the power supply and stops operation immediately when an error occurs.
- In locations with poor power supply conditions, install the necessary protective devices (such as AC reactors) to ensure that the input power is supplied within the specified voltage range. There is a risk of damage to the SERVOPACK.
- Use a Noise Filter to minimize the effects of electromagnetic interference. Electronic devices used near the SERVOPACK may be affected by electromagnetic interference.
- Always use a Servomotor and SERVOPACK in one of the specified combinations.
- Do not touch a SERVOPACK or Servomotor with wet hands. There is a risk of product failure.

■ Storage Precautions



CAUTION

- Do not place an excessive load on the product during storage. (Follow all instructions on the packages.) There is a risk of injury or damage.

NOTICE

- Do not install or store the product in any of the following locations.
 - Locations that are subject to direct sunlight
 - Locations that are subject to ambient temperatures that exceed product specifications
 - Locations that are subject to relative humidities that exceed product specifications
 - Locations that are subject to condensation as the result of extreme changes in temperature
 - Locations that are subject to corrosive or flammable gases
 - Locations that are near flammable materials
 - Locations that are subject to dust, salts, or iron powder
 - Locations that are subject to water, oil, or chemicals
 - Locations that are subject to vibration or shock that exceeds product specifications
 - Locations that are subject to radiation
- If you store or install the product in any of the above locations, the product may fail or be damaged.

■ Transportation Precautions



CAUTION

- Transport the product in a way that is suitable to the mass of the product.
- Do not use the eyebolts on a SERVOPACK or Servomotor to move the machine. There is a risk of damage or injury.
- When you handle a SERVOPACK or Servomotor, be careful of sharp parts, such as the corners. There is a risk of injury.
- Do not place an excessive load on the product during transportation. (Follow all instructions on the packages.) There is a risk of injury or damage.

NOTICE

- **Do not hold onto the front cover or connectors when you move a SERVOPACK.**
There is a risk of the SERVOPACK falling.
- **A SERVOPACK or Servomotor is a precision device. Do not drop it or subject it to strong shock.**
There is a risk of failure or damage.
- **Do not subject connectors to shock.**
There is a risk of faulty connections or damage.
- **If disinfectants or insecticides must be used to treat packing materials such as wooden frames, plywood, or pallets, the packing materials must be treated before the product is packaged, and methods other than fumigation must be used.**
Example: Heat treatment, where materials are kiln-dried to a core temperature of 56°C for 30 minutes or more.
If the electronic products, which include stand-alone products and products installed in machines, are packed with fumigated wooden materials, the electrical components may be greatly damaged by the gases or fumes resulting from the fumigation process. In particular, disinfectants containing halogen, which includes chlorine, fluorine, bromine, or iodine can contribute to the erosion of the capacitors.
- **Do not overtighten the eyebolts on a SERVOPACK or Servomotor.**
If you use a tool to overtighten the eyebolts, the tapped holes may be damaged.

■ Installation Precautions



CAUTION

- **Install the Servomotor or SERVOPACK in a way that will support the mass given in technical documents.**
- **Install SERVOPACKs, Servomotors, regenerative resistors, and External Dynamic Brake Resistors on nonflammable materials.**
Installation directly onto or near flammable materials may result in fire.
- **Provide the specified clearances between the SERVOPACK and the control panel as well as with other devices.**
There is a risk of fire or failure.
- **Install the SERVOPACK in the specified orientation.**
There is a risk of fire or failure.
- **Do not step on or place a heavy object on the product.**
There is a risk of failure, damage, or injury.
- **Do not allow any foreign matter to enter the SERVOPACK or Servomotor.**
There is a risk of failure or fire.

NOTICE

- Do not install or store the product in any of the following locations.
 - Locations that are subject to direct sunlight
 - Locations that are subject to ambient temperatures that exceed product specifications
 - Locations that are subject to relative humidities that exceed product specifications
 - Locations that are subject to condensation as the result of extreme changes in temperature
 - Locations that are subject to corrosive or flammable gases
 - Locations that are near flammable materials
 - Locations that are subject to dust, salts, or iron powder
 - Locations that are subject to water, oil, or chemicals
 - Locations that are subject to vibration or shock that exceeds product specifications
 - Locations that are subject to radiationIf you store or install the product in any of the above locations, the product may fail or be damaged.
- Use the product in an environment that is appropriate for the product specifications.
If you use the product in an environment that exceeds product specifications, the product may fail or be damaged.
- A SERVOPACK or Servomotor is a precision device. Do not drop it or subject it to strong shock.
There is a risk of failure or damage.
- Always install a SERVOPACK in a control panel.
- Do not allow any foreign matter to enter a SERVOPACK or a Servomotor with a Cooling Fan and do not cover the outlet from the Servomotor's cooling fan.
There is a risk of failure.

■ Wiring Precautions



DANGER

- Do not change any wiring while power is being supplied.
There is a risk of electric shock or injury.



WARNING

- Wiring and inspections must be performed only by qualified engineers.
There is a risk of electric shock or product failure.
- Check all wiring and power supplies carefully.
Incorrect wiring or incorrect voltage application to the output circuits may cause short-circuit failures. If a short-circuit failure occurs as a result of any of these causes, the holding brake will not work. This could damage the machine or cause an accident that may result in death or injury.
- Connect the AC and DC power supplies to the specified SERVOPACK terminals.
 - Connect an AC power supply to the L1, L2, and L3 terminals and the L1C and L2C terminals on the SERVOPACK.
 - Connect a DC power supply to the B1/⊕ and ⊖2 terminals and the L1C and L2C terminals on the SERVOPACK.There is a risk of failure or fire.
- If you use a SERVOPACK that supports a Dynamic Brake Option, connect an External Dynamic Brake Resistor that is suitable for the machine and equipment specifications to the specified terminals.
There is a risk of unexpected operation, machine damage, burning, or injury when an emergency stop is performed.



CAUTION

- Wait for six minutes after turning OFF the power supply and then make sure that the CHARGE indicator is not lit before starting wiring or inspection work. Do not touch the power supply terminals while the CHARGE lamp is lit after turning OFF the power supply because high voltage may still remain in the SERVOPACK.
There is a risk of electric shock.
- Observe the precautions and instructions for wiring and trial operation precisely as described in this document.
Failures caused by incorrect wiring or incorrect voltage application in the brake circuit may cause the SERVOPACK to fail, damage the equipment, or cause an accident resulting in death or injury.
- Check the wiring to be sure it has been performed correctly.
Connectors and pin layouts are sometimes different for different models. Always confirm the pin layouts in technical documents for your model before operation.
There is a risk of failure or malfunction.
- Connect wires to power supply terminals and motor connection terminals securely with the specified methods and tightening torque.
Insufficient tightening may cause wires and terminal blocks to generate heat due to faulty contact, possibly resulting in fire.
- Use shielded twisted-pair cables or screened unshielded multi-twisted-pair cables for I/O Signal Cables and Encoder Cables.
- Observe the following precautions when wiring the SERVOPACK's main circuit terminals.
 - Turn ON the power supply to the SERVOPACK only after all wiring, including the main circuit terminals, has been completed.
 - If a connector is used for the main circuit terminals, remove the main circuit connector from the SERVOPACK before you wire it.
 - Insert only one wire per insertion hole in the main circuit terminals.
 - When you insert a wire, make sure that the conductor wire (e.g., whiskers) does not come into contact with adjacent wires.
- Install molded-case circuit breakers and other safety measures to provide protection against short circuits in external wiring.
There is a risk of fire or failure.

NOTICE

- Whenever possible, use the Cables specified by Yaskawa.
If you use any other cables, confirm the rated current and application environment of your model and use the wiring materials specified by Yaskawa or equivalent materials.
- Securely tighten cable connector screws and lock mechanisms.
Insufficient tightening may result in cable connectors falling off during operation.
- Do not bundle power lines (e.g., the Main Circuit Cable) and low-current lines (e.g., the I/O Signal Cables or Encoder Cables) together or run them through the same duct. If you do not place power lines and low-current lines in separate ducts, separate them by at least 30 cm.
If the cables are too close to each other, malfunctions may occur due to noise affecting the low-current lines.
- Install a battery at either the host controller or on the Encoder Cable.
If you install batteries both at the host controller and on the Encoder Cable at the same time, you will create a loop circuit between the batteries, resulting in a risk of damage or burning.
- When connecting a battery, connect the polarity correctly.
There is a risk of battery rupture or encoder failure.

■ Operation Precautions



WARNING

- Before starting operation with a machine connected, change the settings of the switches and parameters to match the machine.
Unexpected machine operation, failure, or personal injury may occur if operation is started before appropriate settings are made.
- Do not radically change the settings of the parameters.
There is a risk of unstable operation, machine damage, or injury.
- Install limit switches or stoppers at the ends of the moving parts of the machine to prevent unexpected accidents.
There is a risk of machine damage or injury.
- For trial operation, securely mount the Servomotor and disconnect it from the machine.
There is a risk of injury.
- Forcing the motor to stop for overtravel is disabled when the Jog (Fn002), Origin Search (Fn003), or Easy FFT (Fn206) utility function is executed. Take necessary precautions.
There is a risk of machine damage or injury.
- When an alarm occurs, the Servomotor will coast to a stop or stop with the dynamic brake according to the SERVOPACK Option specifications and settings. The coasting distance will change with the moment of inertia of the load and the resistance of the External Dynamic Brake Resistor. Check the coasting distance during trial operation and implement suitable safety measures on the machine.
- Do not enter the machine's range of motion during operation.
There is a risk of injury.
- Do not touch the moving parts of the Servomotor or machine during operation.
There is a risk of injury.



CAUTION

- Design the system to ensure safety even when problems, such as broken signal lines, occur. For example, the P-OT and N-OT signals are set in the default settings to operate on the safe side if a signal line breaks. Do not change the polarity of this type of signal.
- When overtravel occurs, the power supply to the motor is turned OFF and the brake is released. If you use the Servomotor to drive a vertical load, set the Servomotor to enter a zero-clamped state after the Servomotor stops. Also, install safety devices (such as an external brake or counterweight) to prevent the moving parts of the machine from falling.
- Always turn OFF the servo before you turn OFF the power supply. If you turn OFF the main circuit power supply or control power supply during operation before you turn OFF the servo, the Servomotor will stop as follows:
 - If you turn OFF the main circuit power supply during operation without turning OFF the servo, the Servomotor will stop abruptly with the dynamic brake.
 - If you turn OFF the control power supply without turning OFF the servo, the stopping method that is used by the Servomotor depends on the model of the SERVOPACK. For details, refer to the manual for the SERVOPACK.
 - If you use a SERVOPACK that supports a Dynamic Brake Option, the Servomotor stopping methods will be different from the stopping methods used without the Option or for other Hardware Option specifications. For details, refer to the *Σ-7-Series AC Servo Drive Σ-7S/Σ-7W SERVOPACK with Hardware Option Specifications Dynamic Brake Product Manual*.
- Do not use the dynamic brake for any application other than an emergency stop.
There is a risk of failure due to rapid deterioration of elements in the SERVOPACK and the risk of unexpected operation, machine damage, burning, or injury.

NOTICE

- When you adjust the gain during system commissioning, use a measuring instrument to monitor the torque waveform and speed waveform and confirm that there is no vibration.
If a high gain causes vibration, the Servomotor will be damaged quickly.
- Do not frequently turn the power supply ON and OFF. After you have started actual operation, allow at least one hour between turning the power supply ON and OFF (as a guideline).
Do not use the product in applications that require the power supply to be turned ON and OFF frequently.
The elements in the SERVOPACK will deteriorate quickly.
- An alarm or warning may occur if communications are performed with the host controller while the SigmaWin+ or Digital Operator is operating.
If an alarm or warning occurs, it may interrupt the current process and stop the system.
- After you complete trial operation of the machine and facilities, use the SigmaWin+ to back up the settings of the SERVOPACK parameters. You can use them to reset the parameters after SERVOPACK replacement.
If you do not copy backed up parameter settings, normal operation may not be possible after a faulty SERVOPACK is replaced, possibly resulting in machine or equipment damage.

■ Maintenance and Inspection Precautions



DANGER

- Do not change any wiring while power is being supplied.
There is a risk of electric shock or injury.



WARNING

- Wiring and inspections must be performed only by qualified engineers.
There is a risk of electric shock or product failure.



CAUTION

- Wait for six minutes after turning OFF the power supply and then make sure that the CHARGE indicator is not lit before starting wiring or inspection work. Do not touch the power supply terminals while the CHARGE lamp is lit after turning OFF the power supply because high voltage may still remain in the SERVOPACK.
There is a risk of electric shock.
- Before you replace a SERVOPACK, back up the settings of the SERVOPACK parameters. Copy the backed up parameter settings to the new SERVOPACK and confirm that they were copied correctly.
If you do not copy backed up parameter settings or if the copy operation is not completed normally, normal operation may not be possible, possibly resulting in machine or equipment damage.

NOTICE

- Discharge all static electricity from your body before you operate any of the buttons or switches inside the front cover of the SERVOPACK.
There is a risk of equipment damage.

■ Troubleshooting Precautions



DANGER

- If the safety device (molded-case circuit breaker or fuse) installed in the power supply line operates, remove the cause before you supply power to the SERVOPACK again. If necessary, repair or replace the SERVOPACK, check the wiring, and remove the factor that caused the safety device to operate.
There is a risk of fire, electric shock, or injury.



WARNING

- The product may suddenly start to operate when the power supply is recovered after a momentary power interruption. Design the machine to ensure human safety when operation restarts.
There is a risk of injury.



CAUTION

- When an alarm occurs, remove the cause of the alarm and ensure safety. Then reset the alarm or turn the power supply OFF and ON again to restart operation.
There is a risk of injury or machine damage.
- If the Servo ON signal is input to the SERVOPACK and an alarm is reset, the Servomotor may suddenly restart operation. Confirm that the servo is OFF and ensure safety before you reset an alarm.
There is a risk of injury or machine damage.
- Always insert a magnetic contactor in the line between the main circuit power supply and the main circuit power supply terminals on the SERVOPACK so that the power supply can be shut OFF at the main circuit power supply.
If a magnetic contactor is not connected when the SERVOPACK fails, a large current may flow, possibly resulting in fire.
- If an alarm occurs, shut OFF the main circuit power supply.
There is a risk of fire due to a regenerative resistor overheating as the result of regenerative transistor failure.
- Install a ground fault detector against overloads and short-circuiting or install a molded-case circuit breaker combined with a ground fault detector.
There is a risk of SERVOPACK failure or fire if a ground fault occurs.
- The holding brake on a Servomotor will not ensure safety if there is the possibility that an external force (including gravity) may move the current position and create a hazardous situation when power is interrupted or an error occurs. If an external force may cause movement, install an external braking mechanism that ensures safety.

■ Disposal Precautions

- When disposing of the product, treat it as ordinary industrial waste. However, local ordinances and national laws must be observed. Implement all labeling and warnings as a final product as required.

■ General Precautions

- Figures provided in this document are typical examples or conceptual representations. There may be differences between them and actual wiring, circuits, and products.
- The products shown in illustrations in this document are sometimes shown without covers or protective guards. Always replace all covers and protective guards before you use the product.
- If you need a new copy of this document because it has been lost or damaged, contact your nearest Yaskawa representative or one of the offices listed on the back of this document.
- This document is subject to change without notice for product improvements, specifications changes, and improvements to the manual itself.
We will update the document number of the document and issue revisions when changes are made.
- Any and all quality guarantees provided by Yaskawa are null and void if the customer modifies the product in any way. Yaskawa disavows any responsibility for damages or losses that are caused by modified products.

Warranty

◆ Details of Warranty

■ Warranty Period

The warranty period for a product that was purchased (hereinafter called the “delivered product”) is one year from the time of delivery to the location specified by the customer or 18 months from the time of shipment from the Yaskawa factory, whichever is sooner.

■ Warranty Scope

Yaskawa shall replace or repair a defective product free of charge if a defect attributable to Yaskawa occurs during the above warranty period.

This warranty does not cover defects caused by the delivered product reaching the end of its service life and replacement of parts that require replacement or that have a limited service life.

This warranty does not cover failures that result from any of the following causes.

- Improper handling, abuse, or use in unsuitable conditions or in environments not described in product catalogs or manuals, or in any separately agreed-upon specifications
- Causes not attributable to the delivered product itself
- Modifications or repairs not performed by Yaskawa
- Use of the delivered product in a manner in which it was not originally intended
- Causes that were not foreseeable with the scientific and technological understanding at the time of shipment from Yaskawa
- Events for which Yaskawa is not responsible, such as natural or human-made disasters

◆ Limitations of Liability

- Yaskawa shall in no event be responsible for any damage or loss of opportunity to the customer that arises due to failure of the delivered product.
- Yaskawa shall not be responsible for any programs (including parameter settings) or the results of program execution of the programs provided by the user or by a third party for use with programmable Yaskawa products.
- The information described in product catalogs or manuals is provided for the purpose of the customer purchasing the appropriate product for the intended application. The use thereof does not guarantee that there are no infringements of intellectual property rights or other proprietary rights of Yaskawa or third parties, nor does it construe a license.
- Yaskawa shall not be responsible for any damage arising from infringements of intellectual property rights or other proprietary rights of third parties as a result of using the information described in catalogs or manuals.

◆ Suitability for Use

- It is the customer's responsibility to confirm conformity with any standards, codes, or regulations that apply if the Yaskawa product is used in combination with any other products.
- The customer must confirm that the Yaskawa product is suitable for the systems, machines, and equipment used by the customer.
- Consult with Yaskawa to determine whether use in the following applications is acceptable. If use in the application is acceptable, use the product with extra allowance in ratings and specifications, and provide safety measures to minimize hazards in the event of failure.
 - Outdoor use, use involving potential chemical contamination or electrical interference, or use in conditions or environments not described in product catalogs or manuals
 - Nuclear energy control systems, combustion systems, railroad systems, aviation systems, vehicle systems, medical equipment, amusement machines, and installations subject to separate industry or government regulations
 - Systems, machines, and equipment that may present a risk to life or property
 - Systems that require a high degree of reliability, such as systems that supply gas, water, or electricity, or systems that operate continuously 24 hours a day
 - Other systems that require a similar high degree of safety
- Never use the product for an application involving serious risk to life or property without first ensuring that the system is designed to secure the required level of safety with risk warnings and redundancy, and that the Yaskawa product is properly rated and installed.
- The circuit examples and other application examples described in product catalogs and manuals are for reference. Check the functionality and safety of the actual devices and equipment to be used before using the product.
- Read and understand all use prohibitions and precautions, and operate the Yaskawa product correctly to prevent accidental harm to third parties.

◆ Specifications Change

The names, specifications, appearance, and accessories of products in product catalogs and manuals may be changed at any time based on improvements and other reasons. The next editions of the revised catalogs or manuals will be published with updated code numbers. Consult with your Yaskawa representative to confirm the actual specifications before purchasing a product.

Compliance with UL Standards, EU Directives, and Other Safety Standards

Certification marks for the standards for which the product has been certified by certification bodies are shown on nameplate. Products that do not have the marks are not certified for the standards.

◆ North American Safety Standards (UL)



Product	Model	North American Safety Standards (UL File No.)
SERVOPACKs	SGD7S	UL 61800-5-1, CSA C22.2 No.274
Rotary Servomotors	<ul style="list-style-type: none"> • SGM7A • SGM7J • SGM7P • SGM7G 	UL 1004-1 UL 1004-6
Direct Drive Servomotors*	SGMCV	
Linear Servomotors	<ul style="list-style-type: none"> • SGLGW • SGLFW • SGLFW2* • SGLTW 	UL 1004 (E165827)

* Certification is scheduled for September 2015.

◆ European Directives



Product	Model	European Directive	Harmonized Standards
SERVOPACKs	SGD7S	Machinery Directive 2006/42/EC	EN ISO13849-1: 2008/AC: 2009
		EMC Directive 2004/108/EC	EN 55011 group 1, class A EN 61000-6-2 EN 61000-6-4 EN 61800-3
		Low Voltage Directive 2006/95/EC	EN 50178 EN 61800-5-1
Rotary Servomotors	<ul style="list-style-type: none"> • SGM7J • SGM7A • SGM7P • SGM7G 	EMC Directive 2004/108/EC	EN 55011 group 1, class A EN 61000-6-2 EN 61000-6-4 EN 61800-3
		Low Voltage Directive 2006/95/EC	EN 60034-1 EN 60034-5
Direct Drive Servomotors	SGM7D*1	EMC Directive 2004/108/EC	EN 55011 group 1, class A EN 61000-6-2 EN 61800-3
		Low Voltage Directive 2006/95/EC	EN 60034-1
	<ul style="list-style-type: none"> • SGMCV • SGMCS- □□B, □□C, □□D, □□E (Small-Capacity, Coreless Servomotors) 	EMC Directive 2004/108/EC	EN 55011 group 1, class A EN 61000-6-2 EN 61800-3*2
		Low Voltage Directive 2006/95/EC	EN 60034-1 EN 60034-5



Product	Model	European Directive	Harmonized Standards
Linear Servomotors	<ul style="list-style-type: none"> • SGLG • SGLF • SGLFW2*1 • SGLT • SGLC 	EMC Directive 2004/108/EC	EN 55011 group 1, class A EN 61000-6-2 EN 61000-6-4
		Low Voltage Directive 2006/95/EC	EN 60034-1

*1. Certification is scheduled for September 2015.

*2. Only the SGMCV is certified.

Note: We declared the CE Marking based on the harmonized standards in the above table.

◆ Safety Standards



Product	Model	Safety Standards	Standards
SERVOPACKs	SGD7S	Safety of Machinery	EN ISO13849-1: 2008/AC: 2009 IEC 60204-1
		Functional Safety	IEC 61508 series IEC 62061 IEC 61800-5-2
		EMC	IEC 61326-3-1

◆ Safety Parameters

Item	Standards	Performance Level
Safety Integrity Level	IEC 61508	SIL3
	IEC 62061	SILCL3
Probability of Dangerous Failure per Hour	IEC 61508 IEC 62061	PFH = 4.04×10^{-9} [1/h] (4.04% of SIL3)
Performance Level	EN ISO 13849-1	PLe (Category 3)
Mean Time to Dangerous Failure of Each Channel	EN ISO 13849-1	MTTFd: High
Average Diagnostic Coverage	EN ISO 13849-1	DCavg: Medium
Stop Category	IEC 60204-1	Stop category 0
Safety Function	IEC 61800-5-2	STO
Mission Time	IEC 61508	10 years
Hardware Fault Tolerance	IEC 61508	HFT = 1
Subsystem	IEC 61508	B

Contents

About this Manual	iii
Outline of Manual	iii
Related Documents	v
Using This Manual	ix
Safety Precautions	xii
Warranty	xxii
Compliance with UL Standards, EU Directives, and Other Safety Standards. .	xxiv

1

Basic Information on SERVOPACKs

1.1	Product Introduction	1-2
1.2	Model Designations	1-3
1.2.1	Interpreting SERVOPACK Model Numbers	1-3
1.2.2	Interpreting Servomotor Model Numbers	1-3
1.3	Combinations of SERVOPACKs and Servomotors	1-4
1.4	Functions	1-5
1.4.1	SERVOPACK Functions	1-5
1.4.2	Functional Restrictions	1-8
1.5	SigmaWin+	1-9
1.6	Combining the SERVOPACKs with MP-Series Machine Controllers and the MPE720 Engineering Tool ..	1-10

2

SERVOPACK Ratings and Specifications

2.1	Ratings	2-2
2.2	SERVOPACK Overload Protection Characteristics	2-4
2.3	Specifications	2-5
2.3.1	SERVOPACKs with Analog Voltage/Pulse Train References	2-5
2.3.2	SERVOPACKs with MECHATROLINK-III Communications References	2-9

3

Less-Deviation Control

3.1	Introduction	3-2
3.2	Restrictions	3-3
3.2.1	Control Mode Restrictions	3-3
3.2.2	Functional Restrictions	3-3
3.2.3	SigmaWin+ Restrictions	3-3
3.2.4	Combining the SERVOPACKs with MP-Series Machine Controllers and the MPE720 Engineering Tool	3-3

3.3	Adjusting Less-Deviation Control 2	3-4
3.3.1	Adjustment Procedure	3-4
3.3.2	Adjustment Example	3-6
3.3.3	Gain Switching Combinations	3-9
3.3.4	Method to Switch the Gain	3-10
3.3.5	Settings for Low-speed Feeding	3-10
3.4	Adjusting Less-Deviation Control 1	3-12
3.4.1	Adjustment Procedure	3-12
3.4.2	Adjustment Example	3-13
3.4.3	Gain Switching Combinations	3-14
3.4.4	Method to Switch the Gain	3-15
3.4.5	Settings for Low-speed Feeding	3-15
3.5	Reference Compensation	3-17
3.6	Monitoring Machine Operation Status and Signal Waveforms . .	3-18

4

Maintenance

4.1	SERVOPACKs with Analog Voltage/Pulse Train References . . .	4-2
4.1.1	Alarm Displays	4-2
4.1.2	List of Alarms	4-2
4.1.3	Troubleshooting Alarms	4-9
4.1.4	Warning Displays	4-37
4.1.5	List of Warnings	4-38
4.1.6	Troubleshooting Warnings	4-39
4.1.7	Troubleshooting Based on the Operation and Conditions of the Servomotor	4-44
4.2	SERVOPACKs with MECHATROLINK-III Communications References . .	4-55
4.2.1	Alarm Displays	4-55
4.2.2	List of Alarms	4-55
4.2.3	Troubleshooting Alarms	4-61
4.2.4	Warning Displays	4-91
4.2.5	List of Warnings	4-92
4.2.6	Troubleshooting Warnings	4-94
4.2.7	Troubleshooting Based on the Operation and Conditions of the Servomotor	4-101

5

Parameter Lists

5.1	SERVOPACKs with Analog Voltage/Pulse Train References . . .	5-2
5.1.1	Interpreting the Parameter Lists	5-2
5.1.2	List of Parameters	5-3
5.1.3	Parameter Recording Table	5-35
5.2	SERVOPACKs with MECHATROLINK-III Communications References . .	5-43
5.2.1	Interpreting the Parameter Lists	5-43
5.2.2	List of Servo Parameters	5-44
5.2.3	List of MECHATROLINK-III Common Parameters	5-84
5.2.4	Parameter Recording Table	5-92

Index

Revision History

Basic Information on SERVOPACKs

1

This chapter provides information required to select SERVOPACKs, such as the SERVOPACK models.

1.1	Product Introduction	1-2
1.2	Model Designations	1-3
1.2.1	Interpreting SERVOPACK Model Numbers	1-3
1.2.2	Interpreting Servomotor Model Numbers	1-3
1.3	Combinations of SERVOPACKs and Servomotors	1-4
1.4	Functions	1-5
1.4.1	SERVOPACK Functions	1-5
1.4.2	Functional Restrictions	1-8
1.5	SigmaWin+	1-9
1.6	Combining the SERVOPACKs with MP-Series Machine Controllers and the MPE720 Engineering Tool	1-10

1.1 Product Introduction

The FT19 SERVOPACKs use less-deviation control to perform tracking. There are the following two modes for less-deviation control. Set the mode in Pn195 = n.X□□□ (Less-Deviation Mode Selection).

Less-Deviation Control Mode	Remarks
Less-Deviation Control 1 (Pn195 = n.0□□□)	Use this mode for compatibility with the Σ -V-EX-Series EX002 SERVO-PACKs.
Less-Deviation Control 2 (Pn195 = n.2□□□)	This mode reduces the maximum deviation and eliminates overshooting before reference distribution has been completed. Adjustments are possible for higher response than with Less-Deviation Control 1 Mode.

Refer to the following chapter for details on less-deviation control.

 *Chapter 3 Less-Deviation Control (page 3-1)*

1.2 Model Designations

1.2.1 Interpreting SERVOPACK Model Numbers



1st+2nd+3rd digits Maximum Applicable Motor Capacity

Voltage	Code	Specification
Three-Phase, 200 VAC	R70*1	0.05 kW
	R90*1	0.1 kW
	1R6*1	0.2 kW
	2R8*1	0.4 kW
	3R8	0.5 kW
	5R5*1	0.75 kW
	7R6	1.0 kW
	120*2	1.5 kW
	180	2.0 kW
	200	3.0 kW
	330	5.0 kW
	470	6.0 kW
	550	7.5 kW
590	11 kW	
780	15 kW	

4th digit Voltage

Code	Specification
A	200 VAC

5th+6th digits Interface*3

Code	Specification
00	Analog voltage/pulse train reference
20	MECHATROLINK-III communications references

7th digit Design Revision Order

A

8th+9th+10th digits Hardware Options Specification

Code	Specification	Applicable Models
000	Without options	All models
001	Rack-mounted	SGD7S-R70A to -330A
	Duct-ventilated	SGD7S-470A to -780A
002	Varnished	All models
008	Single-phase, 200-VAC power supply input	SGD7S-120A

11th+12th+13th digits FT/EX Specification

Code	Specification
F19	Built-in less-deviation control

14th digit BTO Specification*4

Code	Specification
None	None
B	BTO specification

- *1. You can use these models with either a single-phase or three-phase input.
- *2. A model with a single-phase, 200-VAC power supply input is available as a hardware option (model: SGD7S-120A□□A008).
- *3. The same SERVOPACKs are used for both Rotary Servomotors and Linear Servomotors.
- *4. The BTO specification indicates if the SERVOPACK is customized by using the MechatroCloud BTO service. You need a BTO number to order SERVOPACKs with customized specifications. Refer to the following catalog for details on the BTO specification.
 📖 AC Servo Drives Σ-7 Series (Manual No.: KAEP S800001 23)

1.2.2 Interpreting Servomotor Model Numbers

Refer to the following manuals for information on interpreting Σ-7-Series Servomotor model numbers.

- 📖 Σ-7-Series Rotary Servomotor Product Manual (Manual No.: SIEP S800001 36)
- 📖 Σ-7-Series Linear Servomotor Product Manual (Manual No.: SIEP S800001 37)
- 📖 Σ-7-Series Direct Drive Servomotor Product Manual (Manual No.: SIEP S800001 38)

1.3 Combinations of SERVOPACKs and Servomotors

Refer to the following manuals for information on combinations with Σ -7-Series Servomotors.

 Σ -7-Series Rotary Servomotor Product Manual (Manual No.: SIEP S800001 36)

 Σ -7-Series Linear Servomotor Product Manual (Manual No.: SIEP S800001 37)

 Σ -7-Series Direct Drive Servomotor Product Manual (Manual No.: SIEP S800001 38)

1.4 Functions

This section lists the functions provided by SERVOPACKs. Refer to the following manuals for details on the functions.

📖 Σ -7-Series Σ -7S SERVOPACK with Analog Voltage/Pulse Train References Product Manual (Manual No.: SIEP S800001 26)

📖 Σ -7-Series Σ -7S SERVOPACK with MECHATROLINK-III Communications References Product Manual (Manual No.: SIEP S800001 28)

Functions given inside bold lines in the functions tables are restricted if less-deviation control is used for SERVOPACKs for tracking applications. Refer to the following section for details on restrictions to these functions.

📖 1.4.2 Functional Restrictions on page 1-8

1.4.1 SERVOPACK Functions

- Functions Related to the Machine

Function
Power Supply Type Settings for the Main Circuit and Control Circuit
Automatic Detection of Connected Motor
Motor Direction Setting
Linear Encoder Pitch Setting
Writing Linear Servomotor Parameters
Selecting the Phase Sequence for a Linear Servomotor
Polarity Sensor Setting
Polarity Detection
Overtravel Function and Settings
Holding Brake
Motor Stopping Methods for Servo OFF and Alarms
Resetting the Absolute Encoder
Setting the Origin of the Absolute Encoder
Setting the Regenerative Resistor Capacity
Operation for Momentary Power Interruptions
SEMI F47 Function
Setting the Motor Maximum Speed
Software Limits and Settings*
Multiturn Limit Setting
Adjustment of Motor Current Detection Signal Offset
Forcing the Motor to Stop
Speed Ripple Compensation
Current Control Mode Selection
Current Gain Level Setting
Speed Detection Method Selection
Fully-Closed Loop Control
Safety Functions
External Latches*

* These functions can be used with SERVOPACKs with MECHATROLINK-III Communications References.

• Functions Related to the Host Controller

Function
Extended Address Setting
Electronic Gear Settings
I/O Signal Allocations
Servo Alarm (ALM) Signal
Alarm Code (ALO1 to ALO3) Signals*
Warning Output (/WARN) Signal
Rotation Detection (/TGON) Signal
/S-RDY (Servo Ready) Signal
Speed Control*
Basic Settings for Speed Control*
Speed Reference Filter*
Zero Clamping*
Speed Coincidence Detection (/V-CMP) Signal
Position Control*
Reference Pulse Form*
Position Deviation Clear Input (CLR) Signal Function and Settings*
Reference Pulse Input Multiplication Switching*
Positioning Completion (/COIN) Signal
Near (/NEAR) Signal
Reference Pulse Inhibition and Settings*
Torque Control*
Basic Settings for Torque Control*
Torque Reference Filter Settings*
Speed Limit during Torque Control
Speed Limit Detection (/VLT) Signal
Encoder Divided Pulse Output
Selecting Torque Limits
Vibration Detection Level Initialization
Alarm Reset
Replacing the Battery
Setting the Position Deviation Overflow Alarm Level

* These functions can be used with SERVOPACKs with Analog Voltage/Pulse Train References.

- Functions to Achieve Optimum Motions

Function
Speed Control* ¹
Soft Start Settings* ¹
Position Control* ¹
Smoothing Settings* ¹
Torque Control* ¹
Tuning-less Function
Automatic Adjustment without a Host Reference
Automatic Adjustment with a Host Reference
Custom Adjustment
Anti-Resonance Control Adjustment
Vibration Suppression
Gain Selection
Friction Compensation
Backlash Compensation* ²
Model Following Control
Compatible Adjustment Functions
Mechanical Analysis
Easy FFT

*1. These functions can be used with SERVOPACKs with Analog Voltage/Pulse Train References.

*2. These functions can be used with SERVOPACKs with MECHATROLINK-III Communications References.

- Functions for Trial Operation during Setup

Function
Software Reset
Trial Operation of Servomotor without a Load
Program Jogging
Origin Search
Test without a Motor
Monitoring Machine Operation Status and Signal Waveforms

- Functions for Inspection and Maintenance

Function
Write Prohibition Setting for Parameters
Initializing Parameter Settings
Automatic Detection of Connected Motor
Monitoring Product Information
Monitoring Product Life
Alarm History Display

1.4.2 Functional Restrictions

There are restrictions to the following functions when less-deviation control is used.

Function	Restriction
Tuning-less Function (Pn170 = n.□□□X)	The tuning-less function is given priority. Less-deviation control will be disabled even if you set the parameter for less-deviation control (Pn190 = n.□□□1).
Feedforward (Pn109)	This parameter cannot be used. Any parameter setting will be ignored.
Speed Loop Control Method (Pn10B = n.□□X□)	This parameter cannot be used with less-deviation control 2. Any parameter setting will be ignored. This parameter can be used with less-deviation control 1.
Automatic Gain Switching (Pn139 = n.□□□2)	This parameter cannot be used. Do not use it if less-deviation control is enabled.
Model Following Control (Pn140 = n.□□□X)	This parameter cannot be used. Any parameter setting will be ignored and less-deviation control will be given priority.
Reference Pulse Input Multiplier (Pn218) (This parameter is valid only for SERVO-PACKs with Analog Voltage/Pulse Train References.)	This parameter cannot be used. Any parameter setting will be ignored.
Tuning-less Level Setting (Fn200)	This function cannot be used.
Advanced Autotuning without Reference (Fn201)	This function cannot be used.
Advanced Autotuning with Reference (Fn202)	This function cannot be used.
One-Parameter Tuning (Fn203)	For less-deviation control 2, only Tuning Mode 5 can be used. For less-deviation control 1, only Tuning Mode 0 or 1 can be used.
Vibration Suppression (Fn205)	This function cannot be used.

1.5 SigmaWin+

To use the SigmaWin+, a model information file for the SERVOPACK must be added to SigmaWin+ version 7.10 or higher. Contact your Yaskawa representative for the model information file.

1.6

Combining the SERVOPACKs with MP-Series Machine Controllers and the MPE720 Engineering Tool

If you combine the SERVOPACK with an MP-Series Machine Controller or the MPE720 Engineering Tool, it will be recognized as a SERVOPACK with standard specifications. To use the parameters that have been added or changed for the SERVOPACKs described in this manual, use the SigmaWin+.

SERVOPACK Ratings and Specifications

2

This chapter provides information required to select SERVOPACKs, such as specifications.

2.1	Ratings	2-2
2.2	SERVOPACK Overload Protection Characteristics ..	2-4
2.3	Specifications	2-5
2.3.1	SERVOPACKs with Analog Voltage/ Pulse Train References	2-5
2.3.2	SERVOPACKs with MECHATROLINK-III Communications References	2-9

2.1 Ratings

This section gives the ratings of SERVOPACKs.

Three-Phase, 200 VAC

Model SGD7S-		R70A	R90A	1R6A	2R8A	3R8A	5R5A	7R6A	120A	180A	200A	330A	
Maximum Applicable Motor Capacity [kW]		0.05	0.1	0.2	0.4	0.5	0.75	1.0	1.5	2.0	3.0	5.0	
Continuous Output Current [Arms]		0.66	0.91	1.6	2.8	3.8	5.5	7.6	11.6	18.5	19.6	32.9	
Instantaneous Maximum Output Current [Arms]		2.1	3.2	5.9	9.3	11	16.9	17	28	42	56	84	
Main Circuit	Power Supply	200 VAC to 240 VAC, -15% to +10%, 50 Hz/60 Hz											
	Input Current [Arms]*	0.4	0.8	1.3	2.5	3.0	4.1	5.7	7.3	10	15	25	
Control Power Supply		200 VAC to 240 VAC, -15% to +10%, 50 Hz/60 Hz											
Power Supply Capacity [kVA]*		0.2	0.3	0.5	1.0	1.3	1.6	2.3	3.2	4.0	5.9	7.5	
Power Loss*	Main Circuit Power Loss [W]	5.0	7.0	11.9	22.5	28.5	38.9	49.2	72.6	104.2	114.2	226.6	
	Control Circuit Power Loss [W]	12	12	12	12	14	14	14	15	16	16	19	
	Built-in Regenerative Resistor Power Loss [W]	–	–	–	–	8	8	8	10	16	16	36	
	Total Power Loss [W]	17.0	19.0	23.9	34.5	50.5	60.9	71.2	97.6	136.2	146.2	281.6	
Regenerative Resistor	Built-In Regenerative Resistor	Resistance [Ω]	–	–	–	–	40	40	40	20	12	12	8
		Capacity [W]	–	–	–	–	40	40	40	60	60	60	180
	Minimum Allowable External Resistance [Ω]	40	40	40	40	40	40	40	40	20	12	12	8
Overvoltage Category		III											

* This is the net value at the rated load.

Model SGD7S-		470A	550A	590A	780A	
Maximum Applicable Motor Capacity [kW]		6.0	7.5	11	15	
Continuous Output Current [Arms]		46.9	54.7	58.6	78.0	
Instantaneous Maximum Output Current [Arms]		110	130	140	170	
Main Circuit	Power Supply	200 VAC to 240 VAC, -15% to +10%, 50 Hz/60 Hz				
	Input Current [Arms]* ¹	29	37	54	73	
Control Power Supply		200 VAC to 240 VAC, -15% to +10%, 50 Hz/60 Hz				
Power Supply Capacity [kVA]* ¹		10.7	14.6	21.7	29.6	
Power Loss* ¹	Main Circuit Power Loss [W]	271.7	326.9	365.3	501.4	
	Control Circuit Power Loss [W]	21	21	28	28	
	External Regenerative Resistor Power Loss [W]	180* ²	350* ³	350* ³	350* ³	
	Total Power Loss [W]	292.7	347.9	393.3	529.4	
Regenerative Resistor	External Regenerative Resistor	Resistance [Ω]	6.25* ²	3.13* ³	3.13* ³	3.13* ³
		Capacity [W]	880* ²	1760* ³	1760* ³	1760* ³
	Minimum Allowable External Resistance [Ω]	5.8	2.9	2.9	2.9	
Overvoltage Category		III				

*1. This is the net value at the rated load.

*2. This value is for the optional JUSP-RA04-E Regenerative Resistor Unit.

*3. This value is for the optional JUSP-RA05-E Regenerative Resistor Unit.

Single-Phase, 200 VAC

Model SGD7S-		R70A	R90A	1R6A	2R8A	5R5A	120A	
Maximum Applicable Motor Capacity [kW]		0.05	0.1	0.2	0.4	0.75	1.5	
Continuous Output Current [Arms]		0.66	0.91	1.6	2.8	5.5	11.6	
Instantaneous Maximum Output Current [Arms]		2.1	3.2	5.9	9.3	16.9	28	
Main Circuit	Power Supply	200 VAC to 240 VAC, -15% to +10%, 50 Hz/60 Hz						
	Input Current [Arms]*	0.8	1.6	2.4	5.0	8.7	16	
Control Power Supply		200 VAC to 240 VAC, -15% to +10%, 50 Hz/60 Hz						
Power Supply Capacity [kVA]*		0.2	0.3	0.6	1.2	1.9	4.0	
Power Loss*	Main Circuit Power Loss [W]	5.0	7.1	12.1	23.7	39.2	71.8	
	Control Circuit Power Loss [W]	12	12	12	12	14	16	
	Built-in Regenerative Resistor Power Loss [W]	–	–	–	–	8	16	
	Total Power Loss [W]	17.0	19.1	24.1	35.7	61.2	103.8	
Regenerative Resistor	Built-In Regenerative Resistor	Resistance [Ω]	–	–	–	–	40	12
		Capacity [W]	–	–	–	–	40	60
	Minimum Allowable External Resistance [Ω]	40	40	40	40	40	40	12
Overvoltage Category		III						

* This is the net value at the rated load.

270 VDC

Model SGD7S-		R70A	R90A	1R6A	2R8A	3R8A	5R5A	7R6A	120A
Maximum Applicable Motor Capacity [kW]		0.05	0.1	0.2	0.4	0.5	0.75	1.0	1.5
Continuous Output Current [Arms]		0.66	0.91	1.6	2.8	3.8	5.5	7.6	11.6
Instantaneous Maximum Output Current [Arms]		2.1	3.2	5.9	9.3	11.0	16.9	17.0	28.0
Main Circuit	Power Supply	270 VDC to 324 VDC, -15% to +10%							
	Input Current [Arms]*	0.5	1.0	1.5	3.0	3.8	4.9	6.9	11
Control Power Supply		270 VDC to 324 VDC, -15% to +10%							
Power Supply Capacity [kVA]*		0.2	0.3	0.6	1	1.4	1.6	2.3	3.2
Power Loss*	Main Circuit Power Loss [W]	4.4	5.9	9.8	17.5	23.0	30.7	38.7	55.8
	Control Circuit Power Loss [W]	12	12	12	12	14	14	14	15
	Total Power Loss [W]	16.4	17.9	21.8	29.5	37.0	44.7	52.7	70.8
Overvoltage Category		III							

* This is the net value at the rated load.

Model SGD7S-		180A	200A	330A	470A	550A	590A	780A
Maximum Applicable Motor Capacity [kW]		2.0	3.0	5.0	6.0	7.5	11.0	15.0
Continuous Output Current [Arms]		18.5	19.6	32.9	46.9	54.7	58.6	78.0
Instantaneous Maximum Output Current [Arms]		42.0	56.0	84.0	110	130	140	170
Main Circuit	Power Supply	270 VDC to 324 VDC, -15% to +10%						
	Input Current [Arms]*	14	20	34	36	48	68	92
Control Power Supply		270 VDC to 324 VDC, -15% to +10%						
Power Supply Capacity [kVA]*		4.0	5.9	7.5	10.7	14.6	21.7	29.6
Power Loss*	Main Circuit Power Loss [W]	82.7	83.5	146.2	211.6	255.3	243.6	343.4
	Control Circuit Power Loss [W]	16	16	19	21	21	28	28
	Total Power Loss [W]	98.7	99.5	165.2	232.6	276.3	271.6	371.4
Overvoltage Category		III						

* This is the net value at the rated load.

2.2

SERVOPACK Overload Protection Characteristics

The overload detection level is set for hot start conditions with a SERVOPACK surrounding air temperature of 55°C.

An overload alarm (A.710 or A.720) will occur if overload operation that exceeds the overload protection characteristics shown in the following diagram (i.e., operation on the right side of the applicable line) is performed.

The actual overload detection level will be the detection level of the connected SERVOPACK or Servomotor that has the lower overload protection characteristics.

In most cases, that will be the overload protection characteristics of the Servomotor.

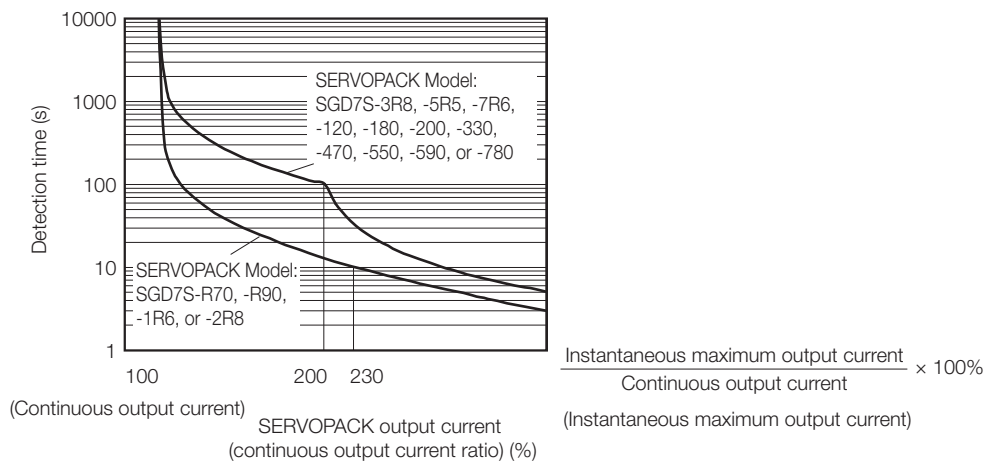



Note: The above overload protection characteristics do not mean that you can perform continuous duty operation with an output of 100% or higher.

For a Yaskawa-specified combination of SERVOPACK and Servomotor, maintain the effective torque within the continuous duty zone of the torque-motor speed characteristic of the Servomotor.

2.3 Specifications

This section gives the general specifications of SERVOPACKs.

2.3.1 SERVOPACKs with Analog Voltage/ Pulse Train References

Item		Specification	
Control Method		IGBT-based PWM control, sine wave current drive	
Feedback	With Rotary Servomotor	Serial encoder: 20 bits or 24 bits (incremental encoder/absolute encoder) 22 bits (absolute encoder)	
	With Linear Servomotor	<ul style="list-style-type: none"> Absolute linear encoder (The signal resolution depends on the absolute linear encoder.) Incremental linear encoder (The signal resolution depends on the incremental linear encoder or Serial Converter Unit.) 	
Environmental Conditions	Surrounding Air Temperature* ¹	-5°C to 55°C (With derating, usage is possible between 55°C and 60°C.) Refer to the following manual for derating specifications.  Σ -7-Series Σ -7S SERVOPACK with Analog Voltage/Pulse Train References Product Manual (Manual No.: SIEP S800001 26)	
	Storage Temperature	-20°C to 85°C	
	Surrounding Air Humidity	95% relative humidity max. (with no freezing or condensation)	
	Storage Humidity	95% relative humidity max. (with no freezing or condensation)	
	Vibration Resistance	4.9 m/s ²	
	Shock Resistance	19.6 m/s ²	
	Degree of Protection	Degree	
		IP20	SERVOPACK Model: SGD7S- R70A, R90A, 1R6A, 2R8A, 3R8A, 5R5A, 7R6A, 120A
		IP10	120A00A008, 180A, 200A, 330A, 470A, 550A, 590A, 780A
	Pollution Degree	2 <ul style="list-style-type: none"> Must be no corrosive or flammable gases. Must be no exposure to water, oil, or chemicals. Must be no dust, salts, or iron dust. 	
Altitude* ¹	1,000 m max. (With derating, usage is possible between 1,000 m and 2,000 m.) Refer to the following manual for derating specifications.  Σ -7-Series Σ -7S SERVOPACK with Analog Voltage/Pulse Train References Product Manual (Manual No.: SIEP S800001 26)		
Others	Do not use the SERVOPACK in the following locations: Locations subject to static electricity noise, strong electromagnetic/magnetic fields, or radioactivity		
Applicable Standards		Refer to the following section for details.  <i>Compliance with UL Standards, EU Directives, and Other Safety Standards on page xxiv</i>	
Mounting	Mounting		
	SERVOPACK Model: SGD7S-		
	Base-mounted	All Models	
	Rack-mounted	R70A, R90A, 1R6A, 2R8A, 3R8A, 5R5A, 7R6A, 120A, 180A, 200A, 330A	
Duct-ventilated	470A, 550A, 590A, 780A		

Continued on next page.

2.3 Specifications

2.3.1 SERVOPACKs with Analog Voltage/ Pulse Train References

Continued from previous page.

Item		Specification	
Performance	Speed Control Range	1:5000 (At the rated torque, the lower limit of the speed control range must not cause the Servomotor to stop.)	
	Coefficient of Speed Fluctuation*2	±0.01% of rated speed max. (for a load fluctuation of 0% to 100%)	
		0% of rated speed max. (for a load fluctuation of ±10%)	
		±0.1% of rated speed max. (for a temperature fluctuation of 25°C ±25°C)	
	Torque Control Precision (Repeatability)	±1%	
Soft Start Time Setting	0 s to 10 s (Can be set separately for acceleration and deceleration.)		
I/O Signals	Encoder Divided Pulse Output	Phase A, phase B, phase C: Line-driver output Number of divided output pulses: Any setting is allowed.	
	Linear Servomotor Overheat Protection Signal Input	Number of input points: 1 Input voltage range: 0 V to +5 V	
	Sequence Input Signals	Fixed Input	Allowable voltage range: 5 VDC ±5% Number of input points: 1 SEN (Absolute Data Request) signal
		Input Signals That Can Be Allocated	Allowable voltage range: 24 VDC ±20% Number of input points: 7
			Input method: Sink inputs or source inputs Input Signals <ul style="list-style-type: none"> • /S-ON (Servo ON) signal • /P-CON (Proportional Control) Signal • P-OT (Forward Drive Prohibit) and N-OT (Reverse Drive Prohibit) signals • /ALM-RST (Alarm Reset) signal • /P-CL (Forward External Torque Limit) and /N-CL (Reverse External Torque Limit) signals • /SPD-D (Motor Direction) signal • /SPD-A and /SPD-B (Internal Set Speed Selection) signals • /C-SEL (Control Selection) signal • /ZCLAMP (Zero Clamping) signal • /INHIBIT (Reference Pulse Inhibit) signal • /P-DET (Polarity Detection) signal • /G-SEL (Gain Selection) signal • /PSEL (Reference Pulse Input Multiplication Switch) Signal • SEN (Absolute Data Request) signal A signal can be allocated and the positive and negative logic can be changed.

Continued on next page.

Continued from previous page.

Item		Specification	
I/O Signals	Sequence Output Signals	Fixed Output	Allowable voltage range: 5 VDC to 30 VDC Number of output points: 1 Output signal: ALM (Servo Alarm) signal
		Output Signals That Can Be Allocated	Allowable voltage range: 5 VDC to 30 VDC Number of output points: 6 (A photocoupler output (isolated) is used for three of the outputs.) (An open-collector output (non-isolated) is used for the other three outputs.) Output Signals <ul style="list-style-type: none"> • /COIN (Positioning Completion) Signal • /V-CMP (Speed Coincidence Detection) Signal • /TGON (Rotation Detection) Signal • /S-RDY (Servo Ready) signal • /CLT (Torque Limit Detection) Signal • /VLT (Speed Limit Detection) Signal • /BK (Brake) signal • /WARN (Warning) Signal • /NEAR (Near) signal • /PSELA (Reference Pulse Input Multiplication Switching Output) signal • ALO1, ALO2, and ALO3 (Alarm Code) signals A signal can be allocated and the positive and negative logic can be changed.
Communi- cations	RS-422A Communi- cations (CN3)	Inter- faces	Digital Operator (JUSP-OP05A-1-E) and personal computer (with SigmaWin+)
		1:N Communi- cations	Up to N = 15 stations possible for RS-422A port
		Axis Address Setting	Set with parameters.
	USB Communi- cations (CN7)	Interface	Personal computer (with SigmaWin+)
		Communi- cations Standard	Conforms to USB2.0 standard (12 Mbps).
Displays/Indicators		CHARGE indicator and five-digit seven-segment display	
Panel Operator		Four push switches	
Analog Monitor (CN5)		Number of points: 2 Output voltage range: ± 10 VDC (effective linearity range: ± 8 V) Resolution: 16 bits Accuracy: ± 20 mV (Typ) Maximum output current: ± 10 mA Settling time ($\pm 1\%$): 1.2 ms (Typ)	
Dynamic Brake (DB)		Activated when a servo alarm or overtravel (OT) occurs, or when the power supply to the main circuit or servo is OFF.	
Regenerative Processing		Built-in (An external resistor must be connected to the SGD7S-470A to -780A.) Refer to the following catalog for details.  AC Servo Drives Σ -7 Series (Manual No.: KAEP S800001 23)	
Overtravel (OT) Prevention		Stopping with dynamic brake, deceleration to a stop, or coasting to a stop for the P-OT (Forward Drive Prohibit) or N-OT (Reverse Drive Prohibit) signal	
Protective Functions		Overcurrent, overvoltage, low voltage, overload, regeneration error, etc.	
Utility Functions		Gain adjustment, alarm history, jogging, origin search, etc.	

Continued on next page.

2.3 Specifications

2.3.1 SERVOPACKs with Analog Voltage/ Pulse Train References

Continued from previous page.

Item		Specification			
Safety Functions	Inputs	/HWBB1 and /HWBB2: Base block signals for Power Modules			
	Output	EDM1: Monitors the status of built-in safety circuit (fixed output).			
	Applicable Standards*3	ISO13849-1 PLe (Category 3) and IEC61508 SIL3			
Applicable Option Modules		Fully-closed Modules and Safety Modules Note: You cannot use a Fully-closed Module and a Safety Module together.			
Controls	Soft Start Time Setting		0 s to 10 s (Can be set separately for acceleration and deceleration.)		
	Speed Control	Input Signal	Reference Voltage	<ul style="list-style-type: none"> Maximum input voltage: ± 12 V (forward motor rotation for positive reference). 6 VDC at rated speed (default setting). Input gain setting can be changed. 	
			Input Impedance	Approx. 14 k Ω	
			Circuit Time Constant	30 μ s	
	Internal Set Speed Control	Rotation Direction Selection	With Proportional Control signal		
		Speed Selection	With Forward/Reverse External Torque Limit signals (speed 1 to 3 selection). Servomotor stops or another control method is used when both signals are OFF.		
	Position Control	Feedforward Compensation		0% to 100%	
		Output Signal Positioning Completed Width Setting		0 to 1,073,741,824 reference units	
		Input Signals	Reference pulses	Reference Pulse Form	One of the following is selected: Sign + pulse train, CW + CCW pulse trains, and two-phase pulse trains with 90° phase differential
				Input Form	Line driver or open collector
				Maximum Input Frequency	<ul style="list-style-type: none"> Line Driver Sign + pulse train or CW + CCW pulse trains: 4 Mpps Two-phase pulse trains with 90° phase differential: 1 Mpps Open Collector Sign + pulse train or CW + CCW pulse trains: 200 kpps Two-phase pulse trains with 90° phase differential: 200 kpps
				Input Multiplication Switching	1 to 100 times
		Clear Signal		Position deviation clear Line driver or open collector	

Continued on next page.

2.3.2 SERVOPACKs with MECHATROLINK-III Communications References

Continued from previous page.

Item			Specification
Controls	Torque Control	Input Signal	<ul style="list-style-type: none"> Maximum input voltage: ±12 V (forward torque output for positive reference). 3 VDC at rated torque (default setting). Input gain setting can be changed.
		Reference Voltage	Approx. 14 kΩ
		Input Impedance	16 μs

*1. If you combine a Σ-7-Series SERVOPACK with a Σ-V-Series Option Module, the following Σ-V-Series SERVOPACKs specifications must be used: a surrounding air temperature of 0°C to 55°C and an altitude of 1,000 m max. Also, the applicable surrounding range cannot be increased by derating.

*2. The coefficient of speed fluctuation for load fluctuation is defined as follows:

$$\text{Coefficient of speed fluctuation} = \frac{\text{No-load motor speed} - \text{Total-load motor speed}}{\text{Rated motor speed}} \times 100\%$$

*3. Always perform risk assessment for the system and confirm that the safety requirements are met.

2.3.2 SERVOPACKs with MECHATROLINK-III Communications References

Item		Specification	
Drive Method		IGBT-based PWM control, sine wave current drive	
Feedback	With Rotary Servomotor	Serial encoder: 20 bits or 24 bits (incremental encoder/absolute encoder) 22 bits (absolute encoder)	
	With Linear Servomotor	<ul style="list-style-type: none"> Absolute linear encoder (The signal resolution depends on the absolute linear encoder.) Incremental linear encoder (The signal resolution depends on the incremental linear encoder or Serial Converter Unit.) 	
Environmental Conditions	Surrounding Air Temperature*1	-5°C to 55°C (With derating, usage is possible between 55°C and 60°C.) Refer to the following manual for derating specifications. ☞ Σ-7-Series Σ-7S SERVOPACK with MECHATROLINK-III Communications References Product Manual (Manual No.: SIEP S800001 28)	
	Storage Temperature	-20°C to 85°C	
	Surrounding Air Humidity	95% relative humidity max. (with no freezing or condensation)	
	Storage Humidity	95% relative humidity max. (with no freezing or condensation)	
	Vibration Resistance	4.9 m/s ²	
	Shock Resistance	19.6 m/s ²	
	Degree of Protection	Degree	SERVOPACK Model: SGD7S-
		IP20	R70A, R90A, 1R6A, 2R8A, 3R8A, 5R5A, 7R6A, 120A
IP10		120A20A008, 180A, 200A, 330A, 470A, 550A, 590A, 780A	
Pollution Degree	2 <ul style="list-style-type: none"> Must be no corrosive or flammable gases. Must be no exposure to water, oil, or chemicals. Must be no dust, salts, or iron dust. 		

Continued on next page.

2.3 Specifications

2.3.2 SERVOPACKs with MECHATROLINK-III Communications References

Continued from previous page.

Item		Specification
Environmental Conditions	Altitude*1	1,000 m max. (With derating, usage is possible between 1,000 m and 2,000 m.) Refer to the following manual for derating specifications. ☞ Σ -7-Series Σ -7S SERVOPACK with MECHATROLINK-III Communications References Product Manual (Manual No.: SIEP S800001 28)
	Others	Do not use the SERVOPACK in the following locations: Locations subject to static electricity noise, strong electromagnetic/magnetic fields, or radioactivity
Applicable Standards		Refer to the following section for details. ☞ <i>Compliance with UL Standards, EU Directives, and Other Safety Standards on page xxiv</i>
Mounting	Mounting	
	Base-mounted	SERVOPACK Model: SGD7S- All Models
	Rack-mounted	R70A, R90A, 1R6A, 2R8A, 3R8A, 5R5A, 7R6A, 120A, 180A, 200A, 330A
	Duct-ventilated	470A, 550A, 590A, 780A
Performance	Speed Control Range	1:5000 (At the rated torque, the lower limit of the speed control range must not cause the Servomotor to stop.)
	Coefficient of Speed Fluctuation*2	$\pm 0.01\%$ of rated speed max. (for a load fluctuation of 0% to 100%)
		0% of rated speed max. (for a load fluctuation of $\pm 10\%$)
		$\pm 0.1\%$ of rated speed max. (for a temperature fluctuation of 25°C $\pm 25^\circ\text{C}$)
Torque Control Precision (Repeatability)	$\pm 1\%$	
Soft Start Time Setting	0 s to 10 s (Can be set separately for acceleration and deceleration.)	
I/O Signals	Encoder Divided Pulse Output	Phase A, phase B, phase C: Line-driver output Number of divided output pulses: Any setting is allowed.
	Linear Servomotor Overheat Protection Signal Input	Number of input points: 1 Input voltage range: 0 V to +5 V
	Sequence Input Signals	Input Signals That Can Be Allocated Allowable voltage range: 24 VDC $\pm 20\%$ Number of input points: 7 Input method: Sink inputs or source inputs Input Signals <ul style="list-style-type: none"> • /DEC (Origin Return Deceleration Switch) signal • /EXT1 to /EXT3 (External Latch Input 1 to 3) signals • P-OT (Forward Drive Prohibit) and N-OT (Reverse Drive Prohibit) signals • /P-CL (Forward External Torque Limit) and /N-CL (Reverse External Torque Limit) signals • /P-DET (Polarity Detection) signal A signal can be allocated and the positive and negative logic can be changed.

Continued on next page.

Continued from previous page.

Item		Specification	
I/O Signals	Fixed Output	Allowable voltage range: 5 VDC to 30 VDC Number of output points: 1 Output signal: ALM (Servo Alarm) signal	
	Sequence Output Signals	Allowable voltage range: 5 VDC to 30 VDC Number of output points: 3 (A photocoupler output (isolated) is used.) Output Signals <ul style="list-style-type: none"> • /COIN (Positioning Completion) signal • /V-CMP (Speed Coincidence Detection) signal • /TGON (Rotation Detection) signal • /S-RDY (Servo Ready) signal • /CLT (Torque Limit Detection) signal • /VLT (Speed Limit Detection) signal • /BK (Brake) signal • /WARN (Warning) signal • /NEAR (Near) signal A signal can be allocated and the positive and negative logic can be changed.	
Communications	RS-422A Communications (CN3)	Inter- faces	Digital Operator (JUSP-OP05A-1-E) and personal computer (with SigmaWin+)
		1:N Communi- cations	Up to N = 15 stations possible for RS-422A port
		Axis Address Setting	Set with parameters.
	USB Communi- cations (CN7)	Interface	Personal computer (with SigmaWin+)
Communi- cations Standard		Conforms to USB2.0 standard (12 Mbps).	
Displays/Indicators		CHARGE, PWR, CN, L1, and L2 indicators, and one-digit seven-seg- ment display	
MECHA- TROLINK-III Communi- cations	Communications Pro- tocol	MECHATROLINK-III	
	Station Address Settings	03 to EF hex (maximum number of slaves: 62) The rotary switches (S1 and S2) are used to set the station address.	
	Baud Rate	100 Mbps	
	Transmission Cycle	125 μ s, 250 μ s, 500 μ s, 750 μ s, 1.0 ms to 4.0 ms (multiples of 0.5 ms)	
	Number of Transmis- sion Bytes	32 or 48 bytes/station A DIP switch (S3) is used to select the number of transmission bytes.	
Reference Method	Performance	Position, speed, or torque control with MECHATROLINK-III communi- cations	
	Reference Input	MECHATROLINK-III commands (sequence, motion, data setting, data access, monitoring, adjustment, etc.)	
	Profile	MECHATROLINK-III standard servo profile	
MECHATROLINK-III Communica- tions Setting Switches		Rotary switch (S1 and S2) positions: 16 Number of DIP switch (S3) pins: 4	
Analog Monitor (CN5)		Number of points: 2 Output voltage range: \pm 10 VDC (effective linearity range: \pm 8 V) Resolution: 16 bits Accuracy: \pm 20 mV (Typ) Maximum output current: \pm 10 mA Settling time (\pm 1%): 1.2 ms (Typ)	
Dynamic Brake (DB)		Activated when a servo alarm or overtravel (OT) occurs, or when the power supply to the main circuit or servo is OFF.	

Continued on next page.

2.3 Specifications

2.3.2 SERVOPACKs with MECHATROLINK-III Communications References

Continued from previous page.

Item		Specification
Regenerative Processing		Built-in (An external resistor must be connected to the SGD7S-470A to -780A.) Refer to the following catalog for details. 📖 AC Servo Drives Σ -7 Series (Manual No.: KAEP S800001 23)
Overtravel (OT) Prevention		Stopping with dynamic brake, deceleration to a stop, or coasting to a stop for the P-OT (Forward Drive Prohibit) or N-OT (Reverse Drive Prohibit) signal
Protective Functions		Overcurrent, overvoltage, low voltage, overload, regeneration error, etc.
Utility Functions		Gain adjustment, alarm history, jogging, origin search, etc.
Safety Functions	Inputs	/HWBB1 and /HWBB2: Base block signals for Power Modules
	Output	EDM1: Monitors the status of built-in safety circuit (fixed output).
	Applicable Standards*3	ISO13849-1 PLe (Category 3), IEC61508 SIL3
Applicable Option Modules		Fully-closed Modules and Safety Modules Note: You cannot use a Fully-closed Module and a Safety Module together.

*1. If you combine a Σ -7-Series SERVOPACK with a Σ -V-Series Option Module, the following Σ -V-Series SERVO-PACKs specifications must be used: a surrounding air temperature of 0°C to 55°C and an altitude of 1,000 m max. Also, the applicable surrounding range cannot be increased by derating.

*2. The coefficient of speed fluctuation for load fluctuation is defined as follows:

$$\text{Coefficient of speed fluctuation} = \frac{\text{No-load motor speed} - \text{Total-load motor speed}}{\text{Rated motor speed}} \times 100\%$$

*3. Always perform risk assessment for the system and confirm that the safety requirements are met.

Less-Deviation Control

3

This chapter describes less-deviation control.

3.1	Introduction	3-2
3.2	Restrictions	3-3
3.2.1	Control Mode Restrictions	3-3
3.2.2	Functional Restrictions	3-3
3.2.3	SigmaWin+ Restrictions	3-3
3.2.4	Combining the SERVOPACKs with MP-Series Machine Controllers and the MPE720 Engineering Tool	3-3
3.3	Adjusting Less-Deviation Control 2	3-4
3.3.1	Adjustment Procedure	3-4
3.3.2	Adjustment Example	3-6
3.3.3	Gain Switching Combinations	3-9
3.3.4	Method to Switch the Gain	3-10
3.3.5	Settings for Low-speed Feeding	3-10
3.4	Adjusting Less-Deviation Control 1	3-12
3.4.1	Adjustment Procedure	3-12
3.4.2	Adjustment Example	3-13
3.4.3	Gain Switching Combinations	3-14
3.4.4	Method to Switch the Gain	3-15
3.4.5	Settings for Low-speed Feeding	3-15
3.5	Reference Compensation	3-17
3.6	Monitoring Machine Operation Status and Signal Waveforms	3-18

3.1 Introduction

You can use less-deviation control to reduce the deviation during movement and increase the locus tracking performance. The FT19 SERVOPACKs are used for applications that require reference tracking performance during movement, including the decrease of tracking error and the prevention of interference between the equipment and moving parts, which can be caused by the influences of position response delay.

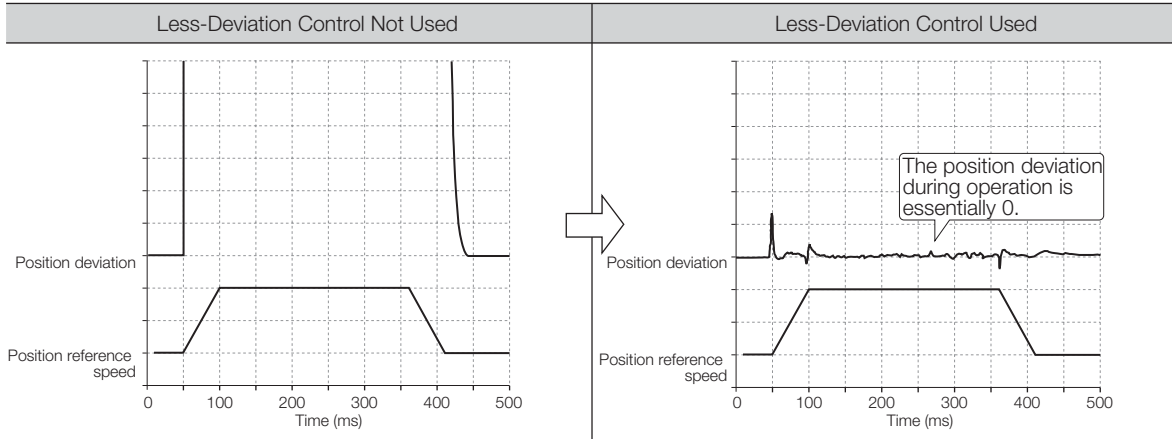

Less-deviation control is enabled or disabled with Pn190 = n.□□□X.

- Pn190 = n.□□□1: Use less-deviation control.
- Pn190 = n.□□□0: Do not use less-deviation control.

Adjusting less-deviation control depends on the less-deviation control mode that you use.

- Less-Deviation Control 1 (Pn195 = n.0□□□): Pn193 and Pn191
- Less-Deviation Control 2 (Pn195 = n.2□□□): Custom Tuning on the SigmaWin+

An outline of the control block diagram for Less-Deviation Control 2 is given below.

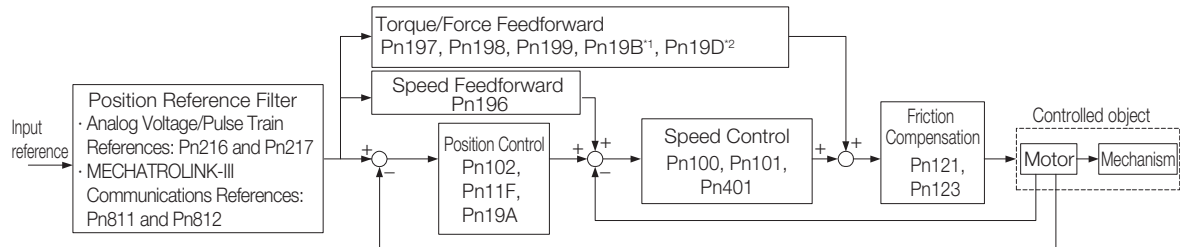

*1. These parameters are used for adjustments for Rotary Servomotors.

*2. These parameters are used for adjustments for Linear Servomotors.

Important If you use less-deviation control under any of the following conditions, vibration, noise, or overshooting may occur.

- Condition 1: The machine has low rigidity. (Guideline: There is a large resonance point in the frequency band from 300 Hz and lower.)
- Condition 2: The machine has large variations in the load.
- Condition 3: The resolution of the encoder is low.

If the condition 1 or 2 is met, do not use less-deviation control. If the condition 3 is met, we recommend using a motor with an encoder that has a resolution of 20 bits or higher. Also, for fully-closed loop control, we recommend using a linear scale (external encoder) that has a resolution equivalent to the motor encoder.

Important The optimum feedforward is set inside the SERVOPACK for less-deviation control. A speed feedforward input or torque feedforward input from the host controller is normally not used at the same time as less-deviation control. However, they can be used together with less-deviation control if necessary. If they are used together and an inappropriate feedforward value is input, overshooting may occur.

3.2 Restrictions

3.2.1 Control Mode Restrictions

Less-deviation control can be used only in Position Control Mode. It cannot be used in Speed Control Mode or Torque Control Mode.

If you change from Speed Control Mode or Torque Control Mode to Position Control Mode, less-deviation control will be enabled after the motor stops.

3.2.2 Functional Restrictions

Refer to the following section for details on restrictions to these functions.

 [1.4.2 Functional Restrictions](#) on page 1-8

3.2.3 SigmaWin+ Restrictions

Refer to the following section for details on restrictions to the SigmaWin+.

 [1.5 SigmaWin+](#) on page 1-9

3.2.4 Combining the SERVOPACKs with MP-Series Machine Controllers and the MPE720 Engineering Tool

Refer to the following section for applications restrictions when the SERVOPACK is combined with an MP-Series Machine Controller or the MPE720 Engineering Tool.



 [1.6 Combining the SERVOPACKs with MP-Series Machine Controllers and the MPE720 Engineering Tool](#) on page 1-10

3.3 Adjusting Less-Deviation Control 2

3.3.1 Adjustment Procedure

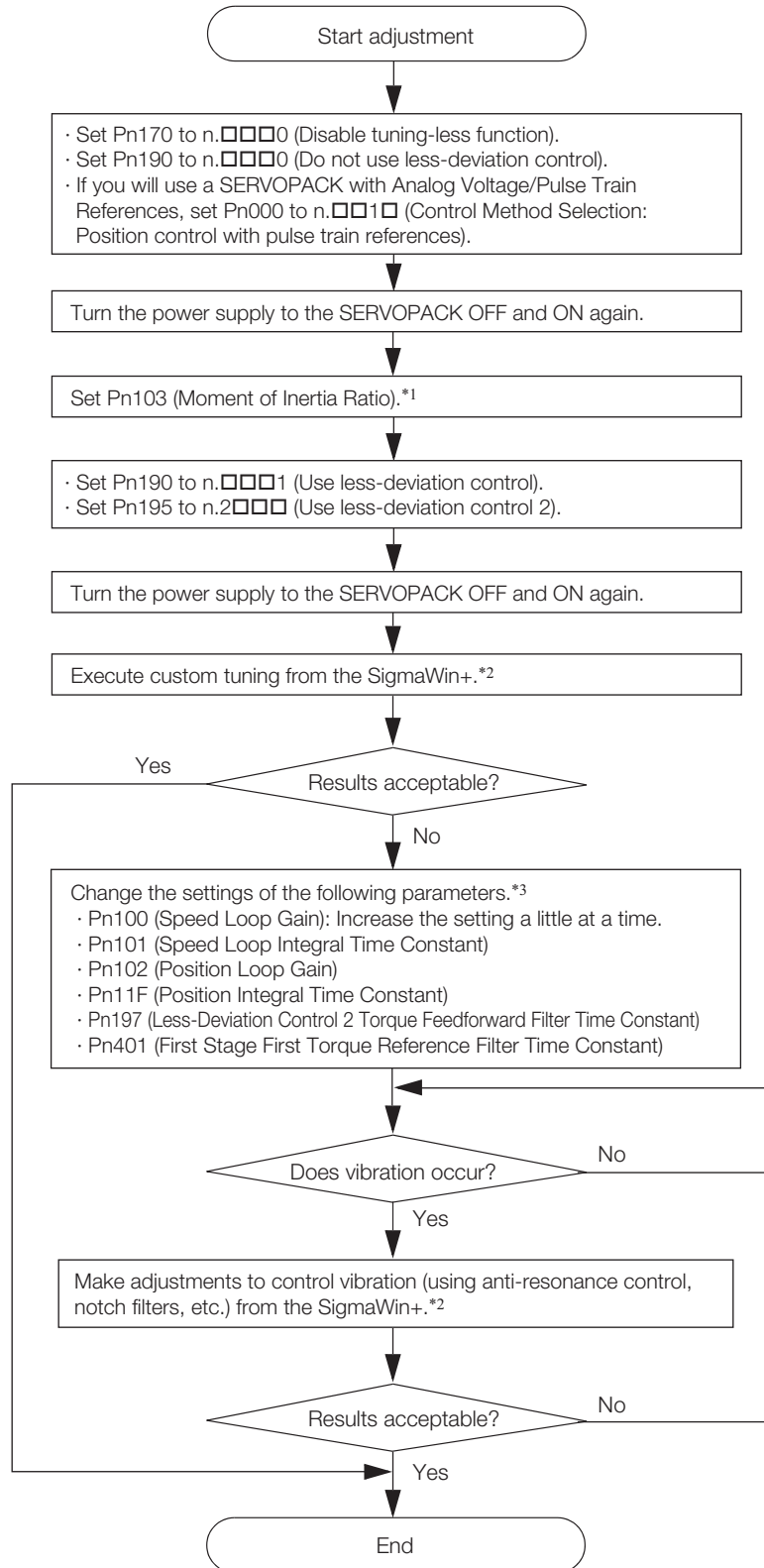
The basic adjustment flowchart for Less-Deviation Control 2 is given in the following figure. Make suitable adjustments considering the conditions and operating requirements of your machine.



- *1. Use one of the following calculation methods.
- Calculate the value manually.
 - Use the following SigmaWin+ function: Moment of Inertia Estimation.
- *2. Refer to one of the following manuals for details.
-  Σ -7-Series Σ -7S SERVOPACK with Analog Voltage/Pulse Train References Product Manual (Manual No.: SIEP S800001 26)
 -  Σ -7-Series Σ -7S SERVOPACK with MECHATROLINK-III Communications References Product Manual (Manual No.: SIEP S800001 28)
- *3. Use the following formulas as guidelines to change the settings.

$$\bullet \text{ Pn101} = \frac{2000}{2\pi \times \text{Pn100}}$$

$$\bullet \text{ Pn102} = \text{Pn100}$$

$$\bullet \text{ Pn11F} = \frac{4000}{\text{Pn102}}$$

$$\bullet \text{ Pn197} = \frac{1000}{2 \times 4 \times 2\pi \times \text{Pn100}}$$

$$\bullet \text{ Pn401} = \frac{1000}{4 \times 2\pi \times \text{Pn100}}$$

The following setting examples are for Pn100 = 40.0 Hz.

$$\bullet \text{ Pn101} = \frac{2000}{2\pi \times 40.0} \cong 7.96$$

$$\bullet \text{ Pn102} = 40.0$$

$$\bullet \text{ Pn11F} = \frac{4000}{40.0} = 100.0$$

$$\bullet \text{ Pn197} = \frac{1000}{2 \times 4 \times 2\pi \times 40.0} \cong 0.50$$

$$\bullet \text{ Pn401} = \frac{1000}{4 \times 2\pi \times 40.0} \cong 0.99$$

3.3.2 Adjustment Example

Adjustment Example for Pn100, Pn101, Pn102, Pn11F, Pn197, and Pn401

The effects of Pn100 (Speed Loop Gain), Pn101 (Speed Loop Integral Time Constant), Pn102 (Position Loop Gain), Pn11F (Position Integral Time Constant), Pn197 (Less-Deviation Control 2 Torque Feedforward Filter Time Constant), and Pn401 (First Stage First Torque Reference Filter Time Constant) are shown below.

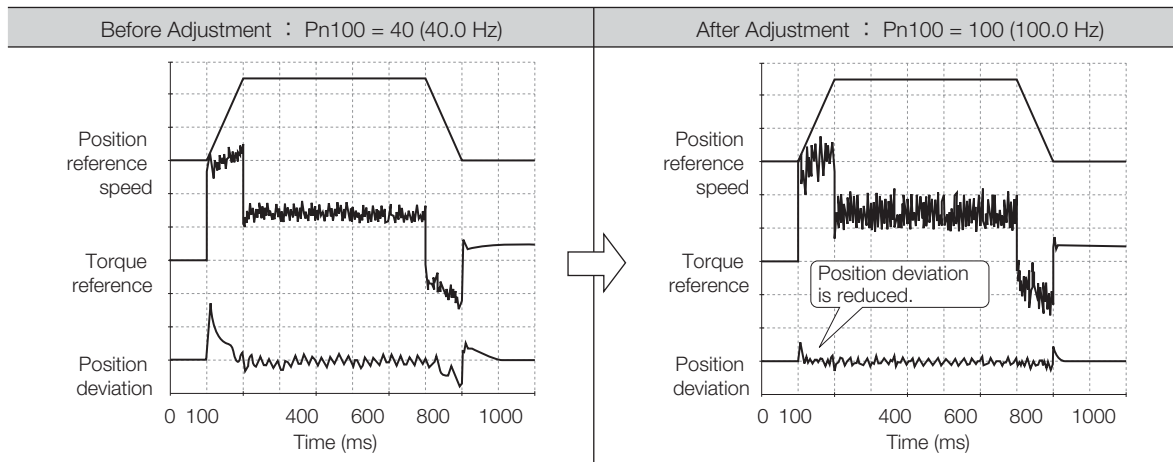

Adjustment Example for Less-Deviation Control 2 Torque Feedforward Gains (Pn198 and Pn199)

The effects of Pn198 (Less-Deviation Control 2 Forward Torque Feedforward Gain) and Pn199 (Less-Deviation Control 2 Reverse Torque Feedforward Gain) are shown below.

Torque feedforward is used for less-deviation control. The torque feedforward operation takes the differential of the input position reference, converts it to an acceleration rate, and multiplies it by the setting of Pn103 (Moment of Inertia Ratio (Mass Ratio)). Therefore, if the setting of Pn103 is smaller than the actual moment of inertia ratio (mass ratio), the effectiveness of reducing the position deviation will be diminished. On the other hand, if the setting of Pn103 is larger than the actual moment of inertia ratio (mass ratio), the position deviation can easily result in overshooting.

In this type of case, you can change the settings of Pn198 and Pn199 to effectively achieve the same things as changing Pn103 only for torque feedback.

Information It is best to correctly set Pn103 (Moment of Inertia Ratio) rather than to adjust the settings of Pn198 and Pn199. However, Pn103 will affect the entire control loop, so changing only the torque feedforward amounts (Pn198 and Pn199) after completing gain adjustment is useful for fine-tuning.

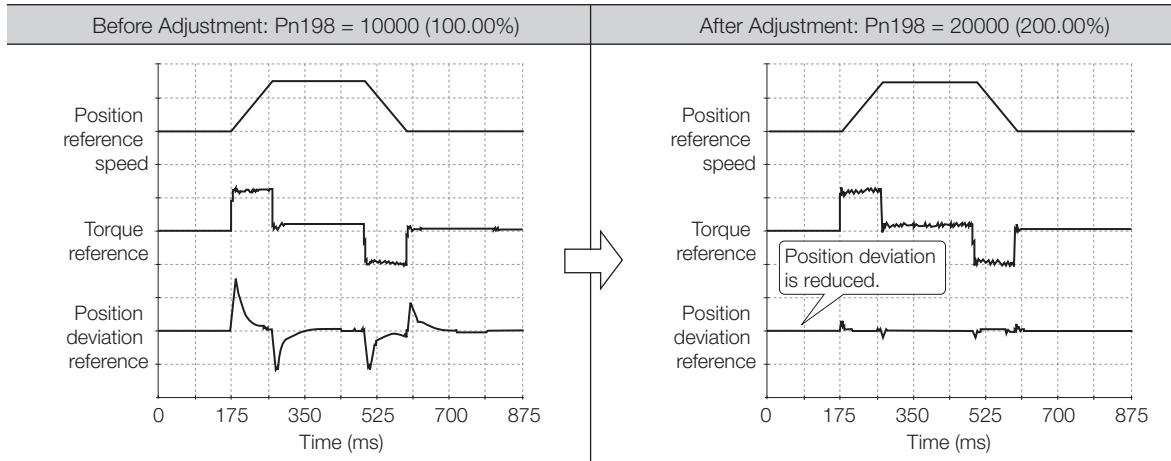

Adjustment Example for Less-Deviation Control 2 Viscous Friction Compensation Coefficients (Pn19B and Pn19D)

For mechanisms that are greatly affected by viscous friction, the effectiveness of torque feedforward (Pn198 and Pn199) is reduced. To allow for this, set one of the following parameters.

- Less-Deviation Control 2 Rotary Servomotor Viscous Friction Compensation Coefficient (Pn19B)
- Less-Deviation Control 2 Linear Servomotor Viscous Friction Compensation Coefficient (Pn19D)

By setting one of the above parameters, an equivalent viscous friction torque is added to the torque feedforward.

Set Pn19B to the percentage of the rated torque [N·m] that occurs at a motor speed of 100 min^{-1} .

The calculations for the setting of Pn19B are given below.

- 1. Operate the motor at a constant speed.**
In this procedure, $1,000 \text{ min}^{-1}$ is used.
- 2. Use a tracing operation on the SigmaWin+ or other means to measure the torque at the speed in step 1.**
Here, we will assume it was 7.5%.
- 3. Calculate the torque at 100 min^{-1} .**
 - Formula: Torque at speed in step 1 (%) $\times 100 \text{ min}^{-1} \div$ Speed in step 1 (min^{-1})

The calculation is as follows for this example:

- $7.5\% \times 100 \text{ min}^{-1} \div 1000 \text{ min}^{-1} = 0.75\%$

Therefore, Pn19B is set to 0.75.

The effects of Pn19B are shown below.

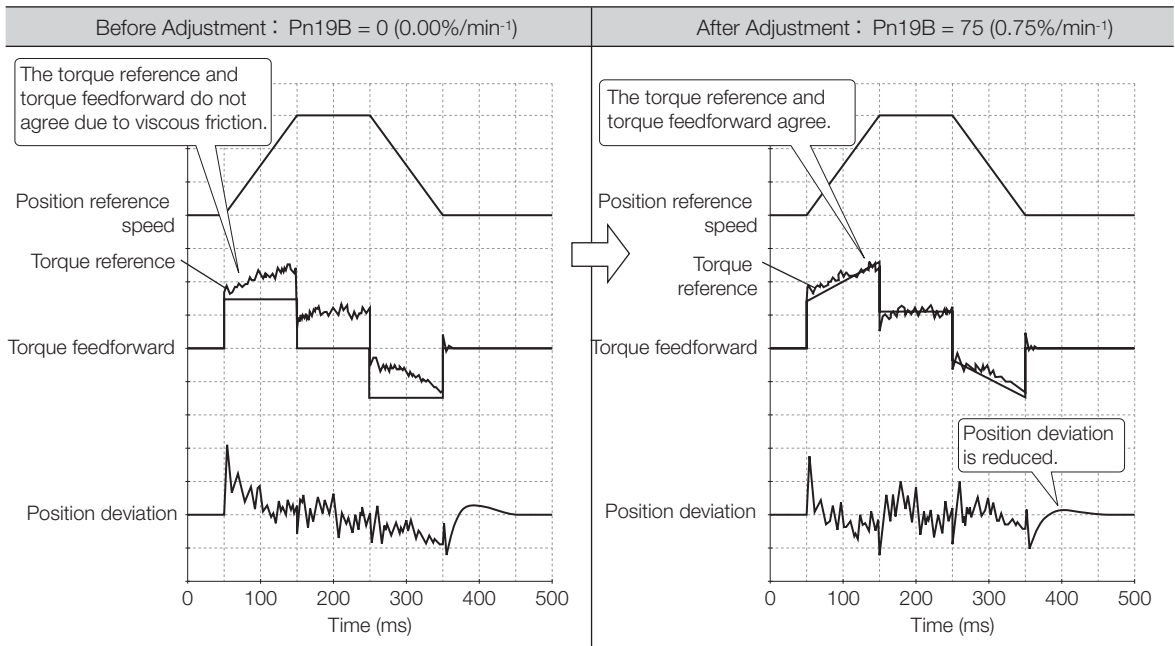

Adjustment Example for Less-Deviation Control 2 Incomplete Integration Rate (Pn19A)

With less-deviation control, the position integral is used to bring the position deviation close to 0 during constant-speed operation. However, a long period of time is normally required for the position deviation to converge to 0 with only position integration. To reduce that trend, the incomplete integral, for which the integral effect falls off with time, is also used. The default setting of Pn19A is 10,000 (100%). In other words, 100% of the previous output from integrator will be subtracted from the current input to the integrator every control cycle.

Therefore, when the deviation settles, the effectiveness of the position integral is lost. However, you can adjust this parameter to increase positioning capability when stopping if you are willing to accept a somewhat longer settling time. If you set this parameter to 0%, operation will be the same as for a normal integrator.

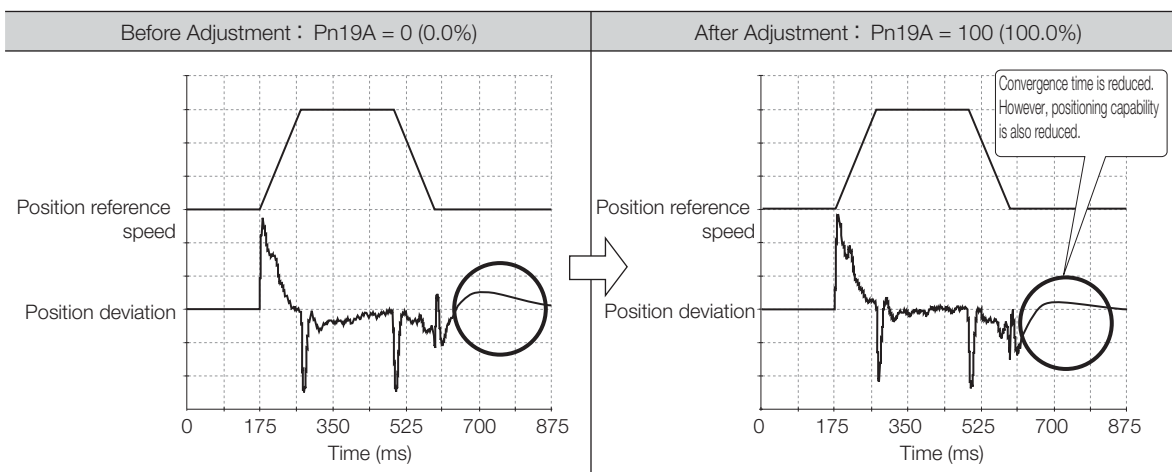

3.3.3 Gain Switching Combinations

You can use gain switching to shorten the positioning time by increasing the gains during positioning and to suppress vibration by decreasing the gains while stopping.

SERVOPACKs with Analog Voltage/Pulse Train References

Selected Gains	Speed Loop Gain	Speed Loop Integral Time Constant	Position Loop Gain	Position Integral Time Constant	Torque Reference Filter	Friction Compensation Gain	Position Reference Acceleration/Deceleration Filter Time Constant*
Gain Settings 1	Speed Loop Gain (Pn100)	Speed Loop Integral Time Constant (Pn101)	Position Loop Gain (Pn102)	Position Integral Time Constant (Pn11F)	First Stage First Torque Reference Filter Time Constant (Pn401)	Friction Compensation Gain (Pn121)	Position Reference Acceleration/Deceleration Time Constant (Pn216)
Gain Settings 2	Second Speed Loop Gain (Pn104)	Second Speed Loop Integral Time Constant (Pn105)	Second Position Loop Gain (Pn106)	Less-Deviation Control 2 Second Position Integral Time Constant (Pn13F)	First Stage Second Torque Reference Filter Time Constant (Pn412)	Second Friction Compensation Gain (Pn122)	Second Position Reference Acceleration/Deceleration Time Constant (Pn234)

* This parameter is valid only for SERVOPACKs with Analog Voltage/Pulse Train References. The gains are switched when there is no reference pulse input and reference distribution has been completed (/DEN). The timing for switching other gains and the timing for switching the Position Reference Acceleration/Deceleration Filter Time Constant are not the same.

SERVOPACKs with MECHATROLINK-III Communications References

Selected Gains	Speed Loop Gain	Speed Loop Integral Time Constant	Position Loop Gain	Position Integral Time Constant	Torque Reference Filter	Friction Compensation Gain
Gain Settings 1	Speed Loop Gain (Pn100)	Speed Loop Integral Time Constant (Pn101)	Position Loop Gain (Pn102)	Position Integral Time Constant (Pn11F)	First Stage First Torque Reference Filter Time Constant (Pn401)	Friction Compensation Gain (Pn121)
Gain Settings 2	Second Speed Loop Gain (Pn104)	Second Speed Loop Integral Time Constant (Pn105)	Second Position Loop Gain (Pn106)	Less-Deviation Control 2 Second Position Integral Time Constant (Pn13F)	First Stage Second Torque Reference Filter Time Constant (Pn412)	Second Friction Compensation Gain (Pn122)

3.3.4 Method to Switch the Gain

SERVOPACKs with Analog Voltage/Pulse Train References

First, make sure that Pn139 is set to n.□□□0 (manual gain switching).

To switch between gain settings 1 and gain settings 2, use the G_SEL external input signal.

Classification	Signal Name	Connector Pin	Setting	Meaning
Input	/G-SEL	Must be assigned with Pn50D = n.□X□□.*	OFF	Changes the gains to gain settings 1.
			ON	Changes the gains to gain settings 2.

* Refer to the following manual for details.

📖 Σ -7-Series Σ -7S SERVOPACK with Analog Voltage/Pulse Train References Product Manual (Manual No.: SIEP S800001 26)

SERVOPACKs with MECHATROLINK-III Communications References

First, make sure that Pn139 is set to n.□□□0 (manual gain switching).

To switch between gain settings 1 and gain settings 2, use G_SEL in the servo command output signals (SVCMD_IO).

Classification	Command Name	Setting	Meaning
Input	G_SEL in the Servo Command Output Signals (SVCMD_IO)	0	Changes the gains to gain settings 1.
		1	Changes the gains to gain settings 2.

3.3.5 Settings for Low-speed Feeding

The tracking performance of less-deviation control is high. Therefore, if the position reference speed input is intermittent during homing or other low-speed operations, the machine may vibrate.

If that occurs, perform the following procedure.

SERVOPACKs with Analog Voltage/Pulse Train References

1. Set Pn234 (Second Position Reference Acceleration/Deceleration Time Constant) to an appropriate value.
2. During low-speed feeding, change the gains from gain settings 1 to gain settings 2. The setting of Pn234 is applied, the reference tracking performance decreases, and vibration is reduced.

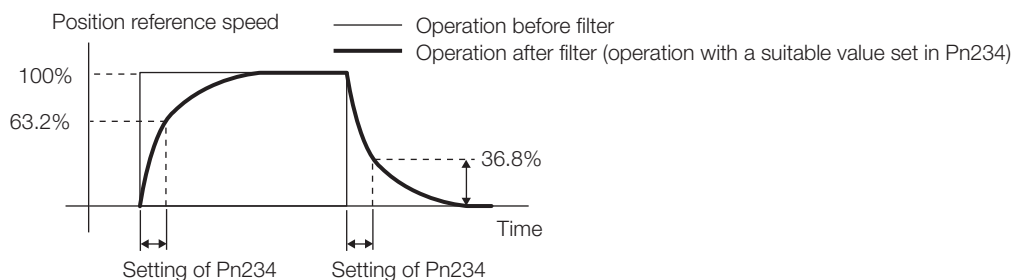



- Any change to the setting of Pn216 or Pn234 is not applied while the Servomotor is operating. Changes will be enabled the next time the Servomotor comes to a stop.
- Change the settings while there is no reference pulse input and the Servomotor is stopped.

SERVOPACKs with MECHATROLINK-III Communications References

There are the following two methods.

- Weakening reference tracking to reduce vibration
- Smoothing references to reduce vibration

◆ Weakening Reference Tracking to Reduce Vibration

During low-speed feeding, the Servo Parameter Write command (SVPRM_WR: 41 hex) is used to reduce the settings of the following three parameters.

- Pn196 (Less-Deviation Control 2 Speed Feedforward Gain)
- Pn198 (Less-Deviation Control 2 Forward Torque Feedforward Gain)
- Pn199 (Less-Deviation Control 2 Reverse Torque Feedforward Gain)

By reducing the settings of Pn196, Pn198, and Pn199, reference tracking is weakened to reduce vibration.

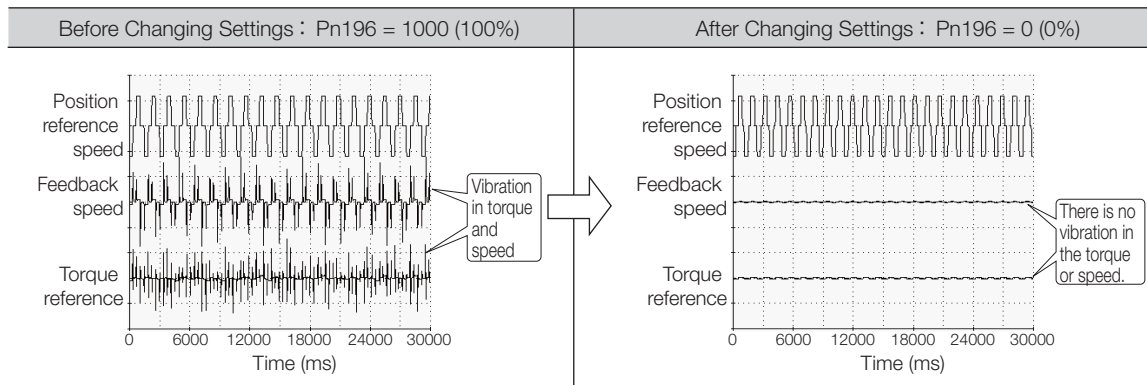

◆ Smoothing References to Reduce Vibration

During low-speed feeding, the Servo Parameter Write command (SVPRM_WR: 41 hex) is used to increase the settings of the following two parameters.

- Pn811 (Exponential Acceleration/Deceleration Time Constant)
- Pn812 (Movement Average Time)

By increasing the settings of Pn811 and Pn812, the reference is smoothed to reduce vibration.

3.4 Adjusting Less-Deviation Control 1

3.4.1 Adjustment Procedure

The basic adjustment flowchart for Less-Deviation Control 1 is given in the following flowchart. Make suitable adjustments considering the conditions and operating requirements of your machine.

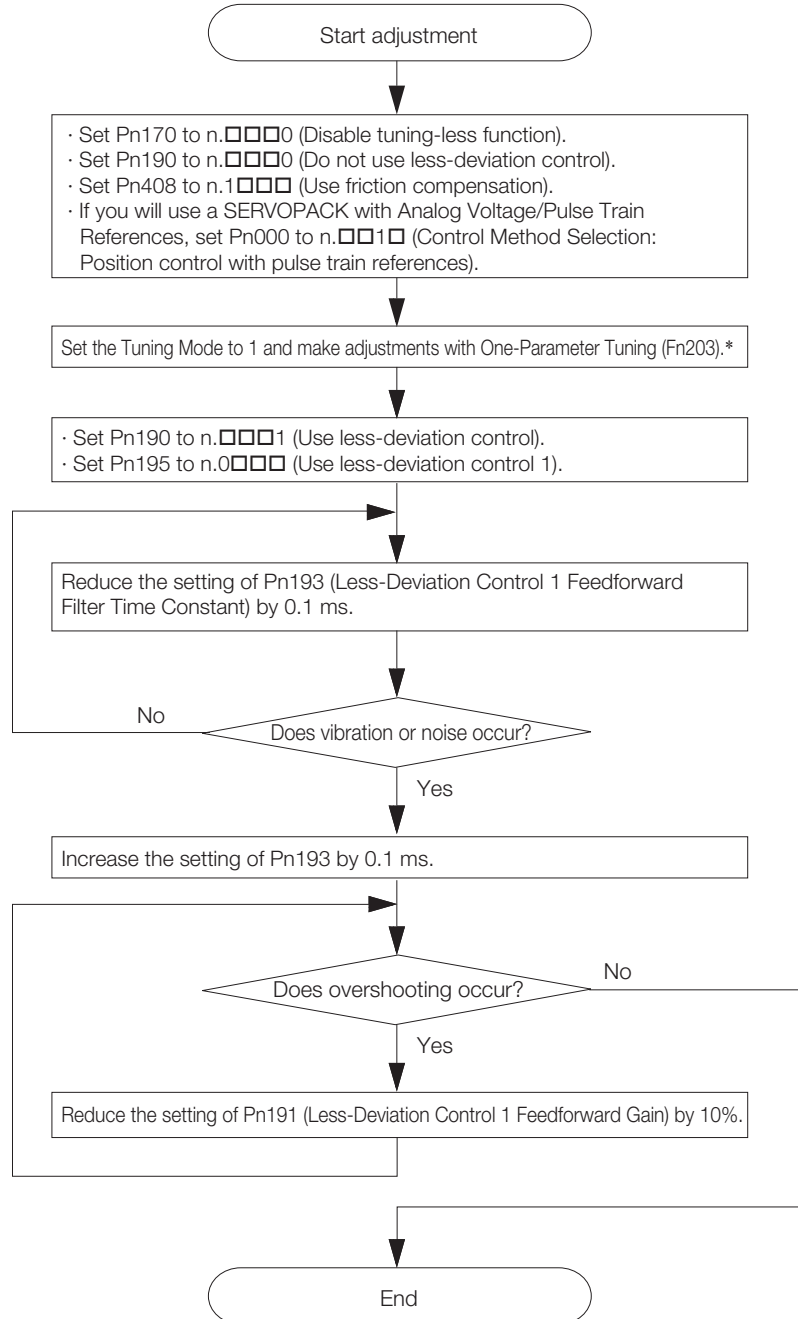

* Refer to one of the following manuals for details.

Σ-7-Series Σ-7S SERVOPACK with Analog Voltage/Pulse Train References Product Manual (Manual No.: SIEP S800001 26)

Σ-7-Series Σ-7S SERVOPACK with MECHATROLINK-III Communications References Product Manual (Manual No.: SIEP S800001 28)

3.4.2 Adjustment Example

Pn193 Adjustment Example

The effects of Pn193 (Less-Deviation Control 1 Feedforward Filter Time Constant) are shown below.

If vibration or noise occurs during operation, increase the setting of Pn193 to reduce vibration and noise. However, overshooting may increase when you do so.

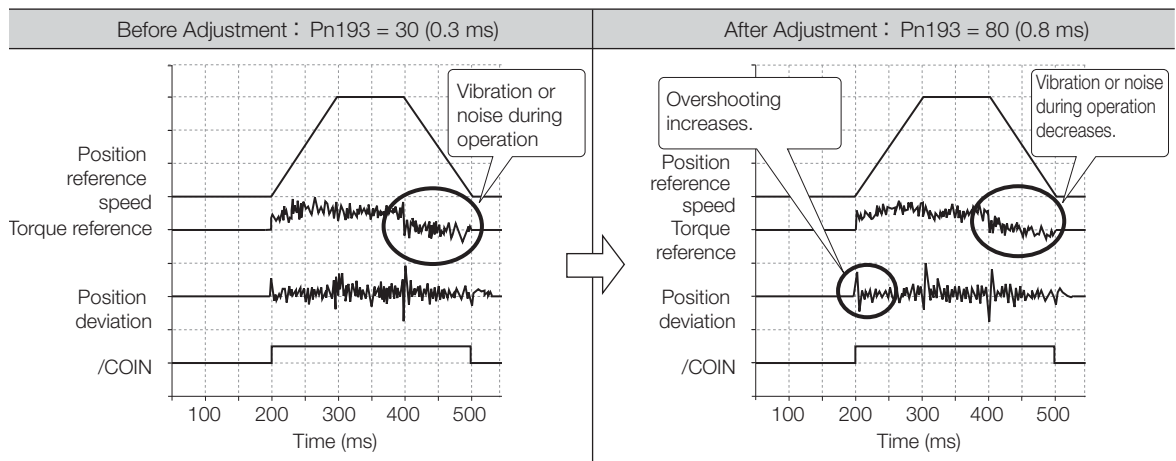

Pn191 Adjustment Example

The effects of Pn191 (Less-Deviation Control 1 Feedforward Gain) are shown below.

If the setting of Pn191 is decreased, overshooting decreases.

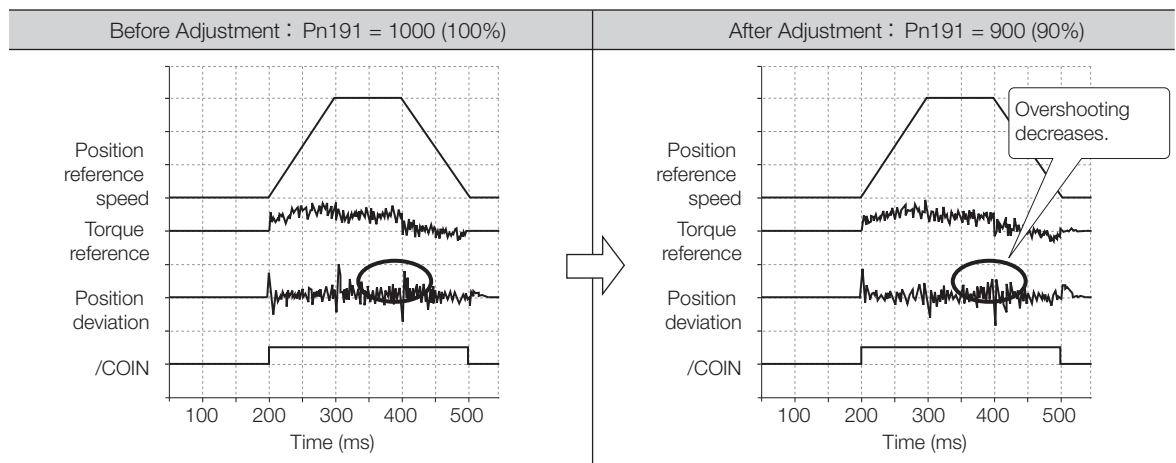

3.4.3 Gain Switching Combinations

You can use gain switching to shorten the positioning time by increasing the gains during positioning and to suppress vibration by decreasing the gains while stopping.

SERVOPACKs with Analog Voltage/Pulse Train References

Selected Gains	Speed Loop Gain	Speed Loop Integral Time Constant	Position Loop Gain	Torque Reference Filter	Friction Compensation Gain	Position Reference Acceleration/Deceleration Filter Time Constant*	Less-Deviation Control Feedforward Gain
Gain Settings 1	Speed Loop Gain (Pn100)	Speed Loop Integral Time Constant (Pn101)	Position Loop Gain (Pn102)	First Stage First Torque Reference Filter Time Constant (Pn401)	Friction Compensation Gain (Pn121)	Position Reference Acceleration/Deceleration Time Constant (Pn216)	Less-Deviation Control 1 Feedforward Gain (Pn191)
Gain Settings 2	Second Speed Loop Gain (Pn104)	Second Speed Loop Integral Time Constant (Pn105)	Second Position Loop Gain (Pn106)	First Stage Second Torque Reference Filter Time Constant (Pn412)	Second Friction Compensation Gain (Pn122)	Second Position Reference Acceleration/Deceleration Time Constant (Pn234)	Less-Deviation Control 1 Second Feedforward Gain (Pn192)

* This parameter is valid only for SERVOPACKs with Analog Voltage/Pulse Train References. The gains are switched when there is no reference pulse input and reference distribution has been completed (/DEN). The timing for switching other gains and the timing of switching the Position Reference Acceleration/Deceleration Filter Time Constant are not the same.

SERVOPACKs with MECHATROLINK-III Communications References

Selected Gains	Speed Loop Gain	Speed Loop Integral Time Constant	Position Loop Gain	Torque Reference Filter	Friction Compensation Gain	Less-Deviation Control Feedforward Gain
Gain Settings 1	Speed Loop Gain (Pn100)	Speed Loop Integral Time Constant (Pn101)	Position Loop Gain (Pn102)	First Stage First Torque Reference Filter Time Constant (Pn401)	Friction Compensation Gain (Pn121)	Less-Deviation Control 1 Feedforward Gain (Pn191)
Gain Settings 2	Second Speed Loop Gain (Pn104)	Second Speed Loop Integral Time Constant (Pn105)	Second Position Loop Gain (Pn106)	First Stage Second Torque Reference Filter Time Constant (Pn412)	Second Friction Compensation Gain (Pn122)	Less-Deviation Control 1 Second Feedforward Gain (Pn192)

3.4.4 Method to Switch the Gain

SERVOPACKs with Analog Voltage/Pulse Train References

First, make sure that Pn139 is set to n.□□□0 (manual gain switching).

To switch between gain settings 1 and gain settings 2, use the G_SEL external input signal.

Classification	Signal Name	Connector Pin	Setting	Meaning
Input	/G-SEL	Must be assigned with Pn50D = n.□X□□.*	OFF	Changes the gains to gain settings 1.
			ON	Changes the gains to gain settings 2.

* Refer to the following manual for details.

📖 Σ -7-Series Σ -7S SERVOPACK with Analog Voltage/Pulse Train References Product Manual
(Manual No.: SIEP S800001 26)

SERVOPACKs with MECHATROLINK-III Communications References

First, make sure that Pn139 is set to n.□□□0 (manual gain switching).

To switch between gain settings 1 and gain settings 2, use G_SEL in the servo command output signals (SVCMD_IO).

Classification	Command Name	Setting	Meaning
Input	G_SEL in the Servo Command Output Signals (SVCMD_IO)	0	Changes the gains to gain settings 1.
		1	Changes the gains to gain settings 2.

3.4.5 Settings for Low-speed Feeding

The tracking performance of less-deviation control is high. Therefore, if the position reference speed input is intermittent during homing or other low-speed operations, the machine may vibrate.

If that occurs, perform the following procedure.

SERVOPACKs with Analog Voltage/Pulse Train References

1. Set Pn234 (Second Position Reference Acceleration/Deceleration Time Constant) to an appropriate value.
2. During low-speed feeding, change the gains from gain settings 1 to gain settings 2. The setting of Pn234 is applied, the reference tracking performance decreases, and vibration is reduced.

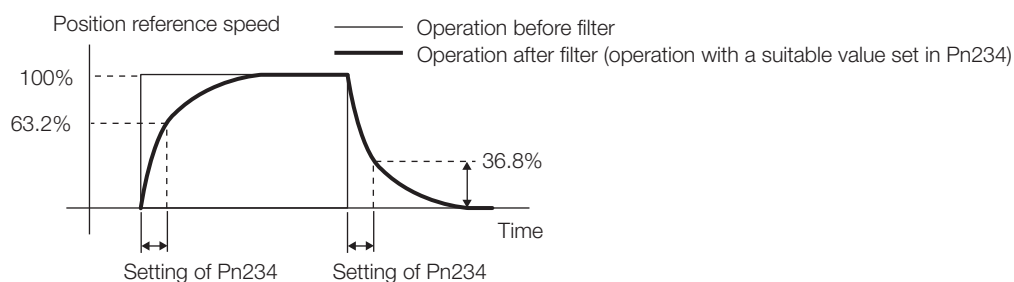



Important

- Any change to the setting of Pn216 or Pn234 is not applied while the Servomotor is operating. Changes will be enabled the next time the Servomotor comes to a stop.
- Change the settings while there is no reference pulse input and the Servomotor is stopped.

SERVOPACKs with MECHATROLINK-III Communications References

1. Set Pn192 (Less-Deviation Control 1 Second Feedforward Gain) to 0.
2. During low-speed feeding, change the gains from gain settings 1 to gain settings 2. The setting of Pn192 is applied, the reference tracking performance decreases, and vibration is reduced.

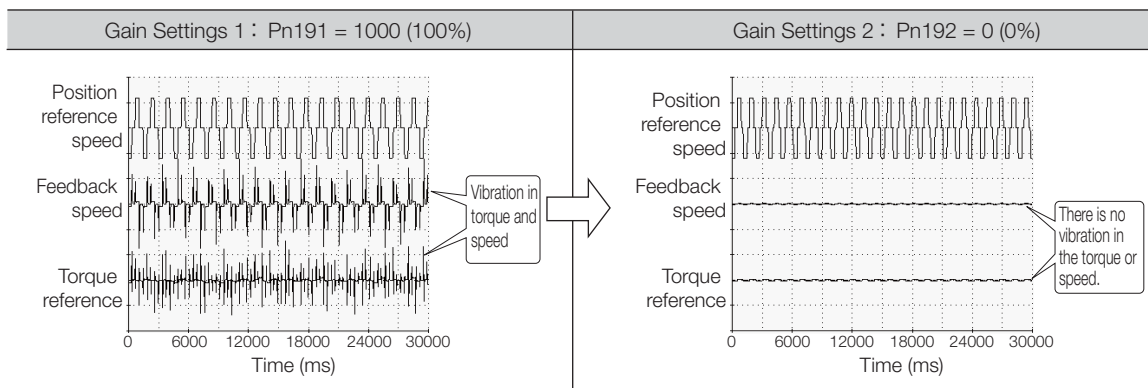

3.5 Reference Compensation

Reference compensation is used when pulse train references are input with SERVOPACKs with Analog Voltage/Pulse Train References.

If less-deviation control is enabled, reference compensation is used by the SERVOPACK to automatically divide the input references to smooth the references. Reference compensation can be used to suppress abnormal noise in motors. However, reference compensation cannot be used for an electronic gear ratio of 16/1 or less (e.g., 4/1 or 1/1).

Also, the division method for the first reference input after the SERVOPACK's control power supply is turned ON is different from the second and later reference inputs, as described below.

- First Reference Input after Control Power Supply Is Turned ON

The input reference pulses are divided by 16 and the input time is multiplied by 16.

SERVOPACK reference read cycle

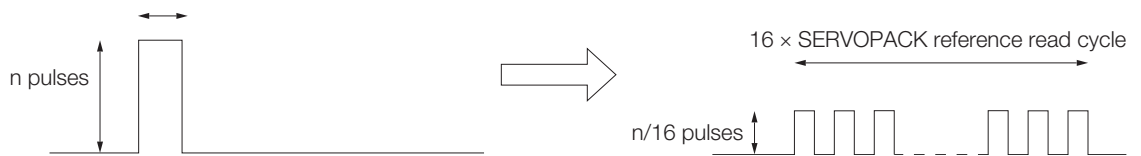

- Second or Later Reference Input after Control Power Supply Is Turned ON

The input reference pulses are divided by 16 and evenly spread over the difference between the last reference input time and this reference input time.

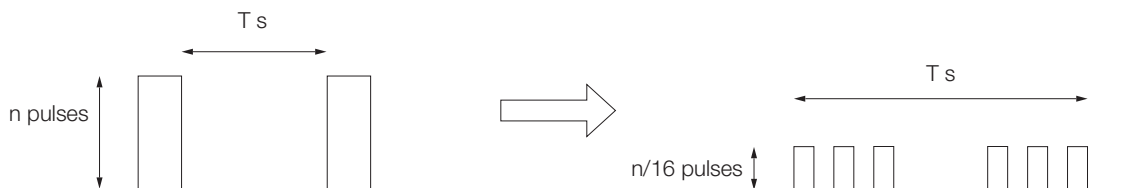

3.6 Monitoring Machine Operation Status and Signal Waveforms

To monitor waveforms, use the SigmaWin+ trace function or a measuring instrument, such as a memory recorder.

The monitoring function that is shaded in the following block diagram was added to SERVOPACKs for tracking applications.

- Monitoring the Position Deviation after the Position Reference Filter

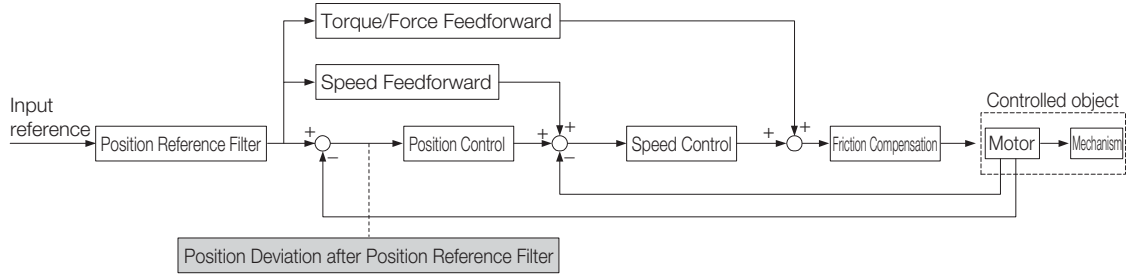

To use the SigmaWin+ to monitor the position deviation after the position reference filter, select the following signal name on the Data Tab Page in the Trace Setup Dialog Box. To display the Trace Setup Dialog Box, click the Setup Button on the Trace Dialog Box.

Signal Name	Unit
Position Deviation after Position Reference Filter	Reference units

To use a measuring instrument to monitor the position deviation after the position reference filter, set Pn006 or Pn007 (Analog Monitor 1/2 Signal Selection) as given in the following table.

Parameter	Description		
	Monitor Signal	Output Unit	Remarks
Pn006 Pn007	n.□□25 Position Deviation after Position Reference Filter	0.05 V/Reference unit	-

Refer to one of the following manuals for details on the monitor items other than the position deviation after the position reference filter.

📖 Σ -7-Series Σ -7S SERVOPACK with Analog Voltage/Pulse Train References Product Manual (Manual No.: SIEP S800001 26)

📖 Σ -7-Series Σ -7S SERVOPACK with MECHATROLINK-III Communications References Product Manual (Manual No.: SIEP S800001 28)

Maintenance

4

This chapter provides information on the meaning of, causes of, and corrections for alarms and warnings.

4.1 SERVOPACKs with Analog Voltage/Pulse Train References . . 4-2

- 4.1.1 Alarm Displays 4-2
- 4.1.2 List of Alarms 4-2
- 4.1.3 Troubleshooting Alarms 4-9
- 4.1.4 Warning Displays 4-37
- 4.1.5 List of Warnings 4-38
- 4.1.6 Troubleshooting Warnings 4-39
- 4.1.7 Troubleshooting Based on the Operation
and Conditions of the Servomotor 4-44

4.2 SERVOPACKs with MECHATROLINK-III Communications References . . 4-55

- 4.2.1 Alarm Displays 4-55
- 4.2.2 List of Alarms 4-55
- 4.2.3 Troubleshooting Alarms 4-61
- 4.2.4 Warning Displays 4-91
- 4.2.5 List of Warnings 4-92
- 4.2.6 Troubleshooting Warnings 4-94
- 4.2.7 Troubleshooting Based on the Operation
and Conditions of the Servomotor 4-101

4.1 SERVOPACKs with Analog Voltage/Pulse Train References

4.1.1 Alarm Displays

If an error occurs in the SERVOPACK, an alarm number will be displayed on the panel display.

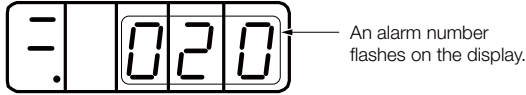

4.1.2 List of Alarms

The list of alarms gives the alarm name, alarm meaning, alarm stopping method, alarm reset possibility, and alarm code output in order of the alarm numbers.

Servomotor Stopping Method for Alarms

Refer to the following manual for information on the stopping method for alarms.

📖 Σ -7-Series Σ -7S SERVOPACK with Analog Voltage/Pulse Train References Product Manual
(Manual No.: SIEP S800001 26)

Alarm Reset Possibility

Yes: You can use an alarm reset to clear the alarm. However, this assumes that the cause of the alarm has been removed.

No: You cannot clear the alarm.

List of Alarms

Alarm Number	Alarm Name	Alarm Meaning	Servo-motor Stopping Method	Alarm Reset Possible?	Alarm Code Output		
					ALO1	ALO2	ALO3
A.020	Parameter Checksum Error	There is an error in the parameter data in the SERVOPACK.	Gr.1	No	H	H	H
A.021	Parameter Format Error	There is an error in the parameter data format in the SERVOPACK.	Gr.1	No	H	H	H
A.022	System Checksum Error	There is an error in the parameter data in the SERVOPACK.	Gr.1	No	H	H	H
A.024	System Alarm	An internal program error occurred in the SERVOPACK.	Gr.1	No	H	H	H
A.025	System Alarm	An internal program error occurred in the SERVOPACK.	Gr.1	No	H	H	H
A.030	Main Circuit Detector Error	There is an error in the detection data for the main circuit.	Gr.1	Yes	H	H	H
A.040	Parameter Setting Error	A parameter setting is outside of the setting range.	Gr.1	No	H	H	H

Continued on next page.

Continued from previous page.

Alarm Number	Alarm Name	Alarm Meaning	Servo-motor Stopping Method	Alarm Reset Possible?	Alarm Code Output		
					AL01	AL02	AL03
A.041	Encoder Output Pulse Setting Error	The setting of Pn212 (Number of Encoder Output Pulses) or Pn281 (Encoder Output Resolution) is outside of the setting range or does not satisfy the setting conditions.	Gr.1	No	H	H	H
A.042	Parameter Combination Error	The combination of some parameters exceeds the setting range.	Gr.1	No	H	H	H
A.044	Semi-Closed/Fully-Closed Loop Control Parameter Setting Error	The settings of the Option Module and Pn002 = n.X□□□ (External Encoder Usage) do not match.	Gr.1	No	H	H	H
A.050	Combination Error	The capacities of the SERVOPACK and Servomotor do not match.	Gr.1	Yes	H	H	H
A.051	Unsupported Device Alarm	An unsupported device was connected.	Gr.1	No	H	H	H
A.070	Motor Type Change Detected	The connected motor is a different type of motor from the previously connected motor.	Gr.1	No	H	H	H
A.080	Linear Encoder Pitch Setting Error	The setting of Pn282 (Linear Encoder Scale Pitch) has not been changed from the default setting.	Gr.1	No	H	H	H
A.0b0	Invalid Servo ON Command Alarm	The /S-ON (Servo ON) signal was input from the host controller after a utility function that turns ON the Servomotor was executed.	Gr.1	Yes	H	H	H
A.100	Overcurrent Detected	An overcurrent flowed through the power transformer or the heat sink overheated.	Gr.1	No	L	H	H
A.101	Motor Overcurrent Detected	The current to the motor exceeded the allowable current.	Gr.1	No	L	H	H
A.300	Regeneration Error	There is an error related to regeneration.	Gr.1	Yes	L	L	H
A.320	Regenerative Overload	A regenerative overload occurred.	Gr.2	Yes	L	L	H
A.330	Main Circuit Power Supply Wiring Error	<ul style="list-style-type: none"> The AC power supply input setting or DC power supply input setting is not correct. The power supply wiring is not correct. 	Gr.1	Yes	L	L	H
A.400	Overvoltage	The main circuit DC voltage is too high.	Gr.1	Yes	H	H	L
A.410	Undervoltage	The main circuit DC voltage is too low.	Gr.2	Yes	H	H	L
A.510	Overspeed	The motor exceeded the maximum speed.	Gr.1	Yes	L	H	L

Continued on next page.

4.1 SERVOPACKs with Analog Voltage/Pulse Train References

4.1.2 List of Alarms

Continued from previous page.

Alarm Number	Alarm Name	Alarm Meaning	Servo-motor Stopping Method	Alarm Reset Possible?	Alarm Code Output		
					ALO1	ALO2	ALO3
A.511	Encoder Output Pulse Overspeed	<ul style="list-style-type: none"> Rotary Servomotor: The pulse output speed for the setting of Pn212 (Number of Encoder Output Pulses) was exceeded. Linear Servomotor: The motor speed upper limit for the setting of Pn281 (Encoder Output Resolution) was exceeded. 	Gr.1	Yes	L	H	L
A.520	Vibration Alarm	Abnormal oscillation was detected in the motor speed.	Gr.1	Yes	L	H	L
A.521	Autotuning Alarm	Vibration was detected during autotuning for the tuning-less function.	Gr.1	Yes	L	H	L
A.550	Maximum Speed Setting Error	The setting of Pn385 (Maximum Motor Speed) is greater than the maximum motor speed.	Gr.1	Yes	L	H	L
A.710	Instantaneous Overload	The Servomotor was operating for several seconds to several tens of seconds under a torque that largely exceeded the rating.	Gr.2	Yes	L	L	L
A.720	Continuous Overload	The Servomotor was operating continuously under a torque that exceeded the rating.	Gr.1	Yes	L	L	L
A.730	Dynamic Brake Overload	When the dynamic brake was applied, the rotational or linear kinetic energy exceeded the capacity of the dynamic brake resistor.	Gr.1	Yes	L	L	L
A.731							
A.740	Inrush Current Limiting Resistor Overload	The main circuit power supply was frequently turned ON and OFF.	Gr.1	Yes	L	L	L
A.7A1	Internal Temperature Error 1 (Control Board Temperature Error)	The surrounding temperature of the control PCB is abnormal.	Gr.2	Yes	L	L	L
A.7A2	Internal Temperature Error 2 (Power Board Temperature Error)	The surrounding temperature of the power PCB is abnormal.	Gr.2	Yes	L	L	L
A.7A3	Internal Temperature Sensor Error	An error occurred in the temperature sensor circuit.	Gr.2	No	L	L	L
A.7Ab	SERVOPACK Built-in Fan Stopped	The fan inside the SERVOPACK stopped.	Gr.1	Yes	L	L	L
A.810	Encoder Backup Alarm	The power supplies to the encoder all failed and the position data was lost.	Gr.1	No	H	H	H
A.820	Encoder Checksum Alarm	There is an error in the checksum results for encoder memory.	Gr.1	No	H	H	H
A.830	Encoder Battery Alarm	The battery voltage was lower than the specified level after the control power supply was turned ON.	Gr.1	Yes	H	H	H

Continued on next page.

Continued from previous page.

Alarm Number	Alarm Name	Alarm Meaning	Servo-motor Stopping Method	Alarm Reset Possible?	Alarm Code Output		
					ALO1	ALO2	ALO3
A.840	Encoder Data Alarm	There is an internal data error in the encoder.	Gr.1	No	H	H	H
A.850	Encoder Overspeed	The encoder was operating at high speed when the power was turned ON.	Gr.1	No	H	H	H
A.860	Encoder Overheated	The internal temperature of the rotary encoder or linear encoder is too high.	Gr.1	No	H	H	H
A.861	Motor Overheated	The internal temperature of motor is too high.	Gr.1	No	H	H	H
A.890	Encoder Scale Error	A failure occurred in the linear encoder.	Gr.1	No	H	H	H
A.891	Encoder Module Error	An error occurred in the linear encoder.	Gr.1	No	H	H	H
A.8A0	External Encoder Error	An error occurred in the external encoder.	Gr.1	Yes	H	H	H
A.8A1	External Encoder Module Error	An error occurred in the Serial Converter Unit.	Gr.1	Yes	H	H	H
A.8A2	External Incremental Encoder Sensor Error	An error occurred in the external encoder.	Gr.1	Yes	H	H	H
A.8A3	External Absolute Encoder Position Error	An error occurred in the position data of the external encoder.	Gr.1	Yes	H	H	H
A.8A5	External Encoder Overspeed	An overspeed error occurred in the external encoder.	Gr.1	Yes	H	H	H
A.8A6	External Encoder Overheated	An overheating error occurred in the external encoder.	Gr.1	Yes	H	H	H
A.b10	Speed Reference A/D Error	An error occurred in the A/D converter for the speed reference input.	Gr.2	Yes	H	H	H
A.b11	Speed Reference A/D Data Error	An error occurred in the A/D conversion data for the speed reference.	Gr.2	Yes	H	H	H
A.b20	Torque Reference A/D Error	An error occurred in the A/D converter for the torque reference input.	Gr.2	Yes	H	H	H
A.b33	Current Detection Error 3	An error occurred in the current detection circuit.	Gr.1	No	H	H	H
A.bF0	System Alarm 0	Internal program error 0 occurred in the SERVOPACK.	Gr.1	No	H	H	H
A.bF1	System Alarm 1	Internal program error 1 occurred in the SERVOPACK.	Gr.1	No	H	H	H
A.bF2	System Alarm 2	Internal program error 2 occurred in the SERVOPACK.	Gr.1	No	H	H	H
A.bF3	System Alarm 3	Internal program error 3 occurred in the SERVOPACK.	Gr.1	No	H	H	H
A.bF4	System Alarm 4	Internal program error 4 occurred in the SERVOPACK.	Gr.1	No	H	H	H

Continued on next page.

4.1 SERVOPACKs with Analog Voltage/Pulse Train References

4.1.2 List of Alarms

Continued from previous page.

Alarm Number	Alarm Name	Alarm Meaning	Servo-motor Stopping Method	Alarm Reset Possible?	Alarm Code Output		
					ALO1	ALO2	ALO3
A.C10	Servomotor Out of Control	The Servomotor ran out of control.	Gr.1	Yes	L	H	L
A.C20	Phase Detection Error	The detection of the phase is not correct.	Gr.1	No	L	H	L
A.C21	Polarity Sensor Error	An error occurred in the polarity sensor.	Gr.1	No	L	H	L
A.C22	Phase Information Dis-agreement	The phase information does not match.	Gr.1	No	L	H	L
A.C50	Polarity Detection Failure	The polarity detection failed.	Gr.1	No	L	H	L
A.C51	Overtravel Detected during Polarity Detection	The overtravel signal was detected during polarity detection.	Gr.1	Yes	L	H	L
A.C52	Polarity Detection Not Completed	The servo was turned ON before the polarity was detected.	Gr.1	Yes	L	H	L
A.C53	Out of Range of Motion for Polarity Detection	The travel distance exceeded the setting of Pn48E (Polarity Detection Range).	Gr.1	No	L	H	L
A.C54	Polarity Detection Failure 2	The polarity detection failed.	Gr.1	No	L	H	L
A.C80	Encoder Clear Error or Multiturn Limit Setting Error	The multiturn data for the absolute encoder was not correctly cleared or set.	Gr.1	No	L	H	L
A.C90	Encoder Communications Error	Communications between the encoder and SERVO-PACK is not possible.	Gr.1	No	L	H	L
A.C91	Encoder Communications Position Data Acceleration Rate Error	An error occurred in calculating the position data of the encoder.	Gr.1	No	L	H	L
A.C92	Encoder Communications Timer Error	An error occurred in the communications timer between the encoder and SERVO-PACK.	Gr.1	No	L	H	L
A.CA0	Encoder Parameter Error	The parameters in the encoder are corrupted.	Gr.1	No	L	H	L
A.Cb0	Encoder Echoback Error	The contents of communications with the encoder are incorrect.	Gr.1	No	L	H	L
A.CC0	Multiturn Limit Disagreement	Different multiturn limits have been set in the encoder and the SERVOPACK.	Gr.1	No	L	H	L
A.CF1	Reception Failed Error in Feedback Option Module Communications	Receiving data from the Feedback Option Module failed.	Gr.1	No	L	H	L
A.CF2	Timer Stopped Error in Feedback Option Module Communications	An error occurred in the timer for communications with the Feedback Option Module.	Gr.1	No	L	H	L
A.d00	Position Deviation Overflow	The setting of Pn520 (Position Deviation Overflow Alarm Level) was exceeded by the position deviation while the servo was ON.	Gr.1	Yes	L	L	H

Continued on next page.

Continued from previous page.

Alarm Number	Alarm Name	Alarm Meaning	Servo-motor Stopping Method	Alarm Reset Possible?	Alarm Code Output		
					AL01	AL02	AL03
A.d01	Position Deviation Overflow Alarm at Servo ON	The servo was turned ON after the position deviation exceeded the setting of Pn526 (Position Deviation Overflow Alarm Level at Servo ON) while the servo was OFF.	Gr.1	Yes	L	L	H
A.d02	Position Deviation Overflow Alarm for Speed Limit at Servo ON	If position deviation remains in the deviation counter, the setting of Pn529 or Pn584 (Speed Limit Level at Servo ON) limits the speed when the servo is turned ON. This alarm occurs if reference pulses are input and the setting of Pn520 (Position Deviation Overflow Alarm Level) is exceeded before the limit is cleared.	Gr.2	Yes	L	L	H
A.d10	Motor-Load Position Deviation Overflow	There was too much position deviation between the motor and load during fully-closed loop control.	Gr.2	Yes	L	L	H
A.d30	Position Data Overflow	The position feedback data exceeded $\pm 1,879,048,192$.	Gr.1	No	L	L	H
A.E71	Safety Option Module Detection Failure	Detection of the Safety Option Module failed.	Gr.1	No	H	L	L
A.E72	Feedback Option Module Detection Failure	Detection of the Feedback Option Module failed.	Gr.1	No	H	L	L
A.E74	Unsupported Safety Option Module	An unsupported Safety Option Module was connected.	Gr.1	No	H	L	L
A.Eb1	Safety Function Signal Input Timing Error	An error occurred in the input timing of the safety function signal.	Gr.1	No	H	L	L
A.EC8	Gate Drive Error 1	An error occurred in the gate drive circuit.	Gr.1	No	H	L	L
A.EC9	Gate Drive Error 2	An error occurred in the gate drive circuit.	Gr.1	No	H	L	L
A.F10	Power Supply Line Open Phase	The voltage was low for more than one second for phase R, S, or T when the main power supply was ON.	Gr.2	Yes	H	L	H
A.F50	Servomotor Main Circuit Cable Disconnection	The Servomotor did not operate or power was not supplied to the Servomotor even though the /S-ON (Servo ON) signal was input when the Servomotor was ready to receive it.	Gr.1	Yes	H	L	H
FL-1*	System Alarm	An internal program error occurred in the SERVOPACK.	-	No	Undefined.		
FL-2*							
FL-3*							
FL-4*							
FL-5*							

Continued on next page.

4.1 SERVOPACKs with Analog Voltage/Pulse Train References

4.1.2 List of Alarms

Continued from previous page.

Alarm Number	Alarm Name	Alarm Meaning	Servo-motor Stopping Method	Alarm Reset Possible?	Alarm Code Output		
					ALO1	ALO2	ALO3
CPF00	Digital Operator Communications Error 1	Communications were not possible between the Digital Operator (model: JUSP-OP05A-1-E) and the SERVO-PACK (e.g., a CPU error occurred).	-	No	Undefined.		
CPF01	Digital Operator Communications Error 2						

* These alarms are not stored in the alarm history. They are only displayed on the panel display.

Note: The A.Eb0, A.Eb2 to A.Eb9, and A.EC0 to A.EC2 alarms can occur when a Safety Module is connected. Refer to the following manual for details.

 AC Servo Drive Σ -V-Series/ Σ -V-Series for Large-Capacity Models/ Σ -7-Series User's Manual Safety Module (Manual No.: SIEP C720829 06)

4.1.3 Troubleshooting Alarms

The causes of and corrections for the alarms are given in the following table. Contact your Yaskawa representative if you cannot solve a problem with the correction given in the table.

Alarm Number: Alarm Name	Possible Cause	Confirmation	Correction	Reference
A.020: Parameter Checksum Error (There is an error in the parameter data in the SER- VOPACK.)	The power supply voltage suddenly dropped.	Measure the power supply voltage.	Set the power supply voltage within the specified range, and initialize the parameter settings.	*1
	The power supply was shut OFF while writing parameter settings.	Check the timing of shutting OFF the power supply.	Initialize the parameter settings and then set the parameters again.	*1
	The number of times that parameters were written exceeded the limit.	Check to see if the parameters were frequently changed from the host controller.	The SERVOPACK may be faulty. Replace the SERVOPACK. Reconsider the method for writing the parameters.	-
	A malfunction was caused by noise from the AC power supply, ground, static electricity, or other source.	Turn the power supply to the SERVOPACK OFF and ON again. If the alarm still occurs, noise may be the cause.	Implement countermeasures against noise.	*1
	Gas, water drops, or cutting oil entered the SERVOPACK and caused failure of the internal components.	Check the installation conditions.	The SERVOPACK may be faulty. Replace the SERVOPACK.	-
	A failure occurred in the SERVOPACK.	Turn the power supply to the SERVOPACK OFF and ON again. If the alarm still occurs, the SERVOPACK may have failed.	The SERVOPACK may be faulty. Replace the SERVOPACK.	-
A.021: Parameter Format Error (There is an error in the parameter data format in the SERVOPACK.)	The software version of the SERVOPACK that caused the alarm is older than the software version of the parameters specified to write.	Read the product information to see if the software versions are the same. If they are different, it could be the cause of the alarm.	Write the parameters from another SERVOPACK with the same model and the same software version, and then turn the power OFF and ON again.	*1
	A failure occurred in the SERVOPACK.	-	The SERVOPACK may be faulty. Replace the SERVOPACK.	-
A.022: System Checksum Error (There is an error in the parameter data in the SERVOPACK.)	The power supply voltage suddenly dropped.	Measure the power supply voltage.	The SERVOPACK may be faulty. Replace the SERVOPACK.	-
	The power supply was shut OFF while setting a utility function.	Check the timing of shutting OFF the power supply.	The SERVOPACK may be faulty. Replace the SERVOPACK.	-
	A failure occurred in the SERVOPACK.	Turn the power supply to the SERVOPACK OFF and ON again. If the alarm still occurs, the SERVOPACK may have failed.	The SERVOPACK may be faulty. Replace the SERVOPACK.	-

Continued on next page.

4.1 SERVOPACKs with Analog Voltage/Pulse Train References

4.1.3 Troubleshooting Alarms

Continued from previous page.

Alarm Number: Alarm Name	Possible Cause	Confirmation	Correction	Reference
A.024: System Alarm (An internal program error occurred in the SERVOPACK.)	A failure occurred in the SERVOPACK.	–	The SERVOPACK may be faulty. Replace the SERVOPACK.	–
A.025: System Alarm (An internal program error occurred in the SERVOPACK.)	A failure occurred in the SERVOPACK.	–	The SERVOPACK may be faulty. Replace the SERVOPACK.	–
A.030: Main Circuit Detector Error	A failure occurred in the SERVOPACK.	–	The SERVOPACK may be faulty. Replace the SERVOPACK.	–
A.040: Parameter Setting Error (A parameter setting is outside of the setting range.)	The SERVOPACK and Servomotor capacities do not match each other.	Check the combination of the SERVOPACK and Servomotor capacities.	Select a proper combination of SERVOPACK and Servomotor capacities.	*1
	A failure occurred in the SERVOPACK.	–	The SERVOPACK may be faulty. Replace the SERVOPACK.	–
	A parameter setting is outside of the setting range.	Check the setting ranges of the parameters that have been changed.	Set the parameters to values within the setting ranges.	–
	The electronic gear ratio is outside of the setting range.	Check the electronic gear ratio. The ratio must be within the following range: $0.001 < (Pn20E/Pn210) < 64,000$.	Set the electronic gear ratio in the following range: $0.001 < (Pn20E/Pn210) < 64,000$.	*1
A.041: Encoder Output Pulse Setting Error	The setting of Pn212 (Number of Encoder Output Pulses) or Pn281 (Encoder Output Resolution) is outside of the setting range or does not satisfy the setting conditions.	Check the setting of Pn212 or Pn281.	Set Pn212 or Pn281 to an appropriate value.	*1

Continued on next page.

Continued from previous page.

Alarm Number: Alarm Name	Possible Cause	Confirmation	Correction	Reference
A.042: Parameter Com- bination Error	The speed of program jogging went below the setting range when the electronic gear ratio (Pn20E/ Pn210) or the Servo- motor was changed.	Check to see if the detection conditions* ² are satisfied.	Decrease the setting of the electronic gear ratio (Pn20E/Pn210).	*1
	The speed of program jogging went below the setting range when Pn533 or Pn585 (Program Jogging Movement Speed) was changed.	Check to see if the detection conditions* ² are satisfied.	Increase the setting of Pn533 or Pn585.	*1
	The movement speed of advanced autotuning went below the setting range when the electronic gear ratio (Pn20E/ Pn210) or the Servomotor was changed.	Check to see if the detection conditions* ³ are satisfied.	Decrease the setting of the electronic gear ratio (Pn20E/Pn210).	*1
A.044: Semi-Closed/ Fully-Closed Loop Control Parameter Setting Error	The setting of the Fully-Closed Module does not match the setting of Pn002 = n.X□□□ (External Encoder Usage).	Check the setting of Pn002 = n.X□□□.	Make sure that the setting of the Fully-closed Mod- ule agrees with the setting of Pn002 = n.X□□□.	*1
A.050: Combination Error (The capacities of the SERVOPACK and Servomotor do not match.)	The SERVOPACK and Servomotor capaci- ties do not match each other.	Check the capacities to see if they satisfy the following condition: $1/4 \leq \frac{\text{Servomotor capacity}}{\text{SERVOPACK capacity}} \leq 4$	Select a proper combina- tion of the SERVOPACK and Servomotor capaci- ties.	*1
	A failure occurred in the encoder.	Replace the encoder and check to see if the alarm still occurs.	Replace the Servomotor or encoder.	–
	A failure occurred in the SERVOPACK.	–	The SERVOPACK may be faulty. Replace the SER- VOPACK.	–
A.051: Unsupported Device Alarm	The motor parameter file was not written to the linear encoder. (This applies only when not using a Serial Converter Unit.)	Check to see if the motor parameter file was written to the lin- ear encoder.	Write the motor parame- ter file to the linear encoder.	*1
	An unsupported Serial Converter Unit or encoder (e.g., an external encoder) is connected to the SERVOPACK.	Check the product combination specifica- tions.	Change to a correct com- bination of models.	–

Continued on next page.

4.1 SERVOPACKs with Analog Voltage/Pulse Train References

4.1.3 Troubleshooting Alarms

Continued from previous page.

Alarm Number: Alarm Name	Possible Cause	Confirmation	Correction	Reference
A.070: Motor Type Change Detected (The connected motor is a different type of motor from the previously connected motor.)	A Rotary Servomotor was removed and a Linear Servomotor was connected.	—	Set the parameters for a Linear Servomotor and reset the motor type alarm. Then, turn the power supply to the SERVOPACK OFF and ON again.	*1
	A Linear Servomotor was removed and a Rotary Servomotor was connected.	—	Set the parameters for a Rotary Servomotor and reset the motor type alarm. Then, turn the power supply to the SERVOPACK OFF and ON again.	*1
A.080: Linear Encoder Pitch Setting Error	The setting of Pn282 (Linear Encoder Scale Pitch) has not been changed from the default setting.	Check the setting of Pn282.	Correct the setting of Pn282.	*1
A.0b0: Invalid Servo ON Command Alarm	The /S-ON (Servo ON) signal was input from the host controller after a utility function that turns ON the Servomotor was executed.	—	Turn the power supply to the SERVOPACK OFF and ON again. Or, execute a software reset.	*1

Continued on next page.

Continued from previous page.

Alarm Number: Alarm Name	Possible Cause	Confirmation	Correction	Reference
A.100: Overcurrent Detected (An overcurrent flowed through the power trans- former or the heat sink overheated.)	The Main Circuit Cable is not wired correctly or there is faulty contact.	Check the wiring.	Correct the wiring.	*1
	There is a short-circuit or ground fault in a Main Circuit Cable.	Check for short-circuits across Servomotor phases U, V, and W, or between the ground and Servomotor phases U, V, and W.	The cable may be short-circuited. Replace the cable.	*1
	There is a short-circuit or ground fault inside the Servomotor.	Check for short-circuits across Servomotor phases U, V, and W, or between the ground and Servomotor phases U, V, or W.	The Servomotor may be faulty. Replace the Servomotor.	*1
	There is a short-circuit or ground fault inside the SERVOPACK.	Check for short-circuits across the Servomotor connection terminals U, V, and W on the SERVOPACK, or between the ground and terminals U, V, or W.	The SERVOPACK may be faulty. Replace the SERVOPACK.	*1
	The regenerative resistor is not wired correctly or there is faulty contact.	Check the wiring.	Correct the wiring.	*1
	The dynamic brake (DB, emergency stop executed from the SERVOPACK) was frequently activated, or a DB overload alarm occurred.	Check the power consumed by the DB resistor to see how frequently the DB is being used. Or, check the alarm display to see if a DB overload alarm (A.730 or A.731) has occurred.	Change the SERVOPACK model, operating methods, or the mechanisms so that the dynamic brake does not need to be used so frequently.	-
	The regenerative processing capacity was exceeded.	Check the regenerative load ratio in the SigmaWin+ Motion Monitor Tab Page to see how frequently the regenerative resistor is being used.	Recheck the operating conditions and load.	*4
	The SERVOPACK regenerative resistance is too small.	Check the regenerative load ratio in the SigmaWin+ Motion Monitor Tab Page to see how frequently the regenerative resistor is being used.	Change the regenerative resistance to a value larger than the SERVOPACK minimum allowable resistance.	*4

Continued on next page.

4.1 SERVOPACKs with Analog Voltage/Pulse Train References

4.1.3 Troubleshooting Alarms

Continued from previous page.

Alarm Number: Alarm Name	Possible Cause	Confirmation	Correction	Reference
A.100: Overcurrent Detected (An overcurrent flowed through the power trans- former or the heat sink overheated.)	A heavy load was applied while the Servomotor was stopped or running at a low speed.	Check to see if the operating conditions exceed Servo Drive specifications.	Reduce the load applied to the Servomotor. Or, increase the operating speed.	-
	A malfunction was caused by noise.	Improve the noise environment, e.g. by improving the wiring or installation conditions, and check to see if the alarm still occurs.	Implement countermeasures against noise, such as correct wiring of the FG. Use an FG wire size equivalent to the SERVOPACK's main circuit wire size.	-
	A failure occurred in the SERVOPACK.	-	Turn the power supply to the SERVOPACK OFF and ON again. If an alarm still occurs, the SERVOPACK may be faulty. Replace the SERVOPACK.	-
A.101: Motor Overcurrent Detected (The current to the motor exceeded the allowable current.)	The Main Circuit Cable is not wired correctly or there is faulty contact.	Check the wiring.	Correct the wiring.	*1
	There is a short-circuit or ground fault in a Main Circuit Cable.	Check for short-circuits across cable phases U, V, and W, or between the ground and cable phases U, V, and W.	The cable may be short-circuited. Replace the cable.	*1
	There is a short-circuit or ground fault inside the Servomotor.	Check for short-circuits across Servomotor phases U, V, and W, or between the ground and Servomotor phases U, V, or W.	The Servomotor may be faulty. Replace the Servomotor.	*1
	There is a short-circuit or ground fault inside the SERVOPACK.	Check for short-circuits across the Servomotor connection terminals U, V, and W on the SERVOPACK, or between the ground and terminals U, V, or W.	The SERVOPACK may be faulty. Replace the SERVOPACK.	*1
	A heavy load was applied while the Servomotor was stopped or running at a low speed.	Check to see if the operating conditions exceed Servo Drive specifications.	Reduce the load applied to the Servomotor. Or, increase the operating speed.	-

Continued on next page.

Continued from previous page.

Alarm Number: Alarm Name	Possible Cause	Confirmation	Correction	Reference
A.101: Motor Overcurrent Detected (The current to the motor exceeded the allowable current.)	A malfunction was caused by noise.	Improve the noise environment, e.g. by improving the wiring or installation conditions, and check to see if the alarm still occurs.	Implement countermeasures against noise, such as correct wiring of the FG. Use an FG wire size equivalent to the SERVOPACK's main circuit wire size.	-
	A failure occurred in the SERVOPACK.	-	Turn the power supply to the SERVOPACK OFF and ON again. If an alarm still occurs, the SERVOPACK may be faulty. Replace the SERVOPACK.	-
A.300: Regeneration Error	Pn600 (Regenerative Resistor Capacity) is not set to 0 and an External Regenerative Resistor is not connected to one of the following SERVOPACKs: SGD7S-R70A, -R90A, -1R6A, -2R8A, or -330A.	Check to see if an External Regenerative Resistor is connected and check the setting of Pn600.	Connect an External Regenerative Resistor, or set Pn600 (Regenerative Resistor Capacity) to 0 (setting unit: $\times 10$ W) if no Regenerative Resistor is required.	*1
	An External Regenerative Resistor is not connected to one of the following SERVOPACKs: SGD7S-470A, -550A, -590A, or -780A.	Check to see if an External Regenerative Resistor or a Regenerative Resistor Unit is connected and check the setting of Pn600.	Connect an External Regenerative Resistor and set Pn600 to an appropriate value, or connect a Regenerative Resistor Unit and set Pn600 to 0.	*1
	The jumper between the regenerative resistor terminals (B2 and B3) was removed from one of the following SERVOPACKs: SGD7S-3R8A, SGD7S-5R5A, SGD7S-7R6A, SGD7S-120A, SGD7S-180A, or SGD7S-200A.	Check to see if the jumper is connected between power supply terminals B2 and B3.	Correctly connect a jumper.	*1
	The External Regenerative Resistor is not wired correctly, or was removed or disconnected.	Check the wiring of the External Regenerative Resistor.	Correct the wiring of the External Regenerative Resistor.	*1
	A failure occurred in the SERVOPACK.	-	While the main circuit power supply is OFF, turn the control power supply to the SERVOPACK OFF and ON again. If an alarm still occurs, the SERVOPACK may be faulty. Replace the SERVOPACK.	-

Continued on next page.

4.1 SERVOPACKs with Analog Voltage/Pulse Train References

4.1.3 Troubleshooting Alarms

Continued from previous page.

Alarm Number: Alarm Name	Possible Cause	Confirmation	Correction	Reference
A.320: Regenerative Overload	The power supply voltage exceeded the specified range.	Measure the power supply voltage.	Set the power supply voltage within the specified range.	–
	The external regenerative resistance value or regenerative resistor capacity is too small, or there has been a continuous regeneration state.	Check the operating conditions or the capacity using the SigmaJunmaSize+ Capacity Selection Software or other means.	Change the regenerative resistance value or capacity. Reconsider the operating conditions using the SigmaJunmaSize+ Capacity Selection Software or other means.	*4
	There was a continuous regeneration state because a negative load was continuously applied.	Check the load applied to the Servomotor during operation.	Reconsider the system including the servo, machine, and operating conditions.	–
	The setting of Pn600 (Regenerative Resistor Capacity) is smaller than the capacity of the External Regenerative Resistor.	Check it see if a Regenerative Resistor is connected and check the setting of Pn600.	Correct the setting of Pn600.	*1
	The setting of Pn603 (Regenerative Resistance) is smaller than the capacity of the External Regenerative Resistor.	Check to see if a Regenerative Resistor is connected and check the setting of Pn603.	Correct the setting of Pn603.	*1
	The external regenerative resistance is too high.	Check the regenerative resistance.	Change the regenerative resistance to a correct value or use an External Regenerative Resistor of an appropriate capacity.	*4
	A failure occurred in the SERVOPACK.	–	The SERVOPACK may be faulty. Replace the SERVOPACK.	–

Continued on next page.

Continued from previous page.

Alarm Number: Alarm Name	Possible Cause	Confirmation	Correction	Reference
A.330: Main Circuit Power Supply Wiring Error (Detected when the main circuit power supply is turned ON.)	The regenerative resistor was disconnected when the SERVOPACK power supply voltage was high.	Measure the resistance of the regenerative resistor using a measuring instrument.	If you are using the regenerative resistor built into the SERVOPACK, replace the SERVOPACK. If you are using an External Regenerative Resistor, replace the External Regenerative Resistor.	–
	DC power was supplied when an AC power supply input was specified in the settings.	Check the power supply to see if it is a DC power supply.	Correct the power supply setting to match the actual power supply.	*1
	AC power was supplied when a DC power supply input was specified in the settings.	Check the power supply to see if it is an AC power supply.	Correct the power supply setting to match the actual power supply.	*1
	Pn600 (Regenerative Resistor Capacity) is not set to 0 and an External Regenerative Resistor is not connected to one of the following SERVO-PACKs: SGD7S-R70A, SGD7S-R90A, SGD7S-1R6A, or SGD7S-2R8A.	Check it see if an External Regenerative Resistor is connected and check the setting of Pn600.	Connect an External Regenerative Resistor, or if an External Regenerative Resistor is not required, set Pn600 to 0.	*1
	A failure occurred in the SERVOPACK.	–	The SERVOPACK may be faulty. Replace the SERVOPACK.	–

Continued on next page.

4.1 SERVOPACKs with Analog Voltage/Pulse Train References

4.1.3 Troubleshooting Alarms

Continued from previous page.

Alarm Number: Alarm Name	Possible Cause	Confirmation	Correction	Reference
A.400: Overvoltage (Detected in the main circuit power supply section of the SERVOPACK.)	The power supply voltage exceeded the specified range.	Measure the power supply voltage.	Set the AC/DC power supply voltage within the specified range.	-
	The power supply is not stable or was influenced by a lightning surge.	Measure the power supply voltage.	Improve the power supply conditions, install a surge absorber, and then turn the power supply OFF and ON again. If an alarm still occurs, the SERVOPACK may be faulty. Replace the SERVOPACK.	-
	The voltage for AC power supply was too high during acceleration or deceleration.	Check the power supply voltage and the speed and torque during operation.	Set the AC power supply voltage within the specified range.	-
	The external regenerative resistance is too high for the operating conditions.	Check the operating conditions and the regenerative resistance.	Select a regenerative resistance value that is appropriate for the operating conditions and load.	*4
	The moment of inertia ratio or mass ratio exceeded the allowable value.	Check to see if the moment of inertia ratio or mass ratio is within the allowable range.	Increase the deceleration time, or reduce the load.	-
	A failure occurred in the SERVOPACK.	-	While the main circuit power supply is OFF, turn the control power supply to the SERVOPACK OFF and ON again. If an alarm still occurs, the SERVOPACK may be faulty. Replace the SERVOPACK.	-
A.410: Undervoltage (Detected in the main circuit power supply section of the SERVOPACK.)	The power supply voltage went below the specified range.	Measure the power supply voltage.	Set the power supply voltage within the specified range.	-
	The power supply voltage dropped during operation.	Measure the power supply voltage.	Increase the power supply capacity.	-
	A momentary power interruption occurred.	Measure the power supply voltage.	If you have changed the setting of Pn509 (Momentary Power Interruption Hold Time), decrease the setting.	*1
	The SERVOPACK fuse is blown out.	-	Replace the SERVOPACK and connect a reactor to the DC reactor terminals (⊖1 and ⊖2) on the SERVOPACK.	-
	A failure occurred in the SERVOPACK.	-	The SERVOPACK may be faulty. Replace the SERVOPACK.	-

Continued on next page.

Continued from previous page.

Alarm Number: Alarm Name	Possible Cause	Confirmation	Correction	Reference
A.510: Overspeed (The motor exceeded the maximum speed.)	The order of phases U, V, and W in the motor wiring is not correct.	Check the wiring of the Servomotor.	Make sure that the Servomotor is correctly wired.	–
	A reference value that exceeded the over-speed detection level was input.	Check the input reference.	Reduce the reference value. Or, adjust the gain.	*1
	The motor exceeded the maximum speed.	Check the waveform of the motor speed.	Reduce the speed reference input gain and adjust the servo gain. Or, reconsider the operating conditions.	*1
	A failure occurred in the SERVOPACK.	–	The SERVOPACK may be faulty. Replace the SERVOPACK.	–
A.511: Encoder Output Pulse Overspeed	The encoder output pulse frequency exceeded the limit.	Check the encoder output pulse setting.	Decrease the setting of Pn212 (Number of Encoder Output Pulses) or Pn281 (Encoder Output Resolution).	*1
	The encoder output pulse frequency exceeded the limit because the motor speed was too high.	Check the encoder output pulse setting and the motor speed.	Reduce the motor speed.	–
A.520: Vibration Alarm	Abnormal oscillation was detected in the motor speed.	Check for abnormal motor noise, and check the speed and torque waveforms during operation.	Reduce the motor speed. Or, reduce the setting of Pn100 (Speed Loop Gain).	*1
	The setting of Pn103 (Moment of Inertia Ratio) is greater than the actual moment of inertia or was greatly changed.	Check the moment of inertia ratio or mass ratio.	Set Pn103 (Moment of Inertia Ratio) to an appropriate value.	*1
	The vibration detection level (Pn312 or Pn384) is not suitable.	Check that the vibration detection level (Pn312 or Pn384) is suitable.	Set a suitable vibration detection level (Pn312 or Pn384).	*1
A.521: Autotuning Alarm (Vibration was detected while executing the custom tuning, Easy FFT, or the tuning-less function.)	The Servomotor vibrated considerably while performing the tuning-less function.	Check the waveform of the motor speed.	Reduce the load so that the moment of inertia ratio is within the allowable value. Or increase the load level or reduce the rigidity level in the tuning-less level settings.	*1
	The Servomotor vibrated considerably while performing custom tuning or Easy FFT.	Check the waveform of the motor speed.	Check the operating procedure of corresponding function and implement corrections.	*1
A.550: Maximum Speed Setting Error	The setting of Pn385 (Maximum Motor Speed) is greater than the maximum speed.	Check the setting of Pn385, and the upper limits of the maximum motor speed setting and the encoder output resolution setting.	Set Pn385 to a value that does not exceed the maximum motor speed.	*1

Continued on next page.

4.1 SERVOPACKs with Analog Voltage/Pulse Train References

4.1.3 Troubleshooting Alarms

Continued from previous page.

Alarm Number: Alarm Name	Possible Cause	Confirmation	Correction	Reference
A.710: Instantaneous Overload A.720: Continuous Overload	The wiring is not correct or there is a faulty contact in the motor or encoder wiring.	Check the wiring.	Make sure that the Servomotor and encoder are correctly wired.	*1
	Operation was performed that exceeded the overload protection characteristics.	Check the motor overload characteristics and Run command.	Reconsider the load and operating conditions. Or, increase the motor capacity.	-
	An excessive load was applied during operation because the Servomotor was not driven due to mechanical problems.	Check the operation reference and motor speed.	Correct the mechanical problem.	-
	There is an error in the setting of Pn282 (Linear Encoder Scale Pitch).	Check the setting of Pn282.	Correct the setting of Pn282.	*1
	There is an error in the setting of Pn080 = n.□□X□ (Motor Phase Sequence Selection).	Check the setting of Pn080 = n.□□X□.	Set Pn080 = n.□□X□ to an appropriate value.	*1
	A failure occurred in the SERVOPACK.	-	The SERVOPACK may be faulty. Replace the SERVOPACK.	-
A.730 and A.731: Dynamic Brake Overload (An excessive power consumption by the dynamic brake was detected.)	The Servomotor was rotated by an external force.	Check the operation status.	Implement measures to ensure that the motor will not be rotated by an external force.	-
	When the Servomotor was stopped with the dynamic brake, the rotational or linear kinetic energy exceeded the capacity of the dynamic brake resistor.	Check the power consumed by the DB resistor to see how frequently the DB is being used.	Reconsider the following: <ul style="list-style-type: none"> • Reduce the Servomotor command speed. • Decrease the moment of inertia ratio or mass ratio. • Reduce the frequency of stopping with the dynamic brake. 	-
	A failure occurred in the SERVOPACK.	-	The SERVOPACK may be faulty. Replace the SERVOPACK.	-
A.740: Inrush Current Limiting Resistor Overload (The main circuit power supply was frequently turned ON and OFF.)	The allowable frequency of the inrush current limiting resistor was exceeded when the main circuit power supply was turned ON and OFF.	-	Reduce the frequency of turning the main circuit power supply ON and OFF.	-
	A failure occurred in the SERVOPACK.	-	The SERVOPACK may be faulty. Replace the SERVOPACK.	-

Continued on next page.

Continued from previous page.

Alarm Number: Alarm Name	Possible Cause	Confirmation	Correction	Reference
A.7A1: Internal Temperature Error 1 (Control Board Temperature Error)	The surrounding temperature is too high.	Check the surrounding temperature using a thermostat. Or, check the operating status with the SERVOPACK installation environment monitor.	Decrease the surrounding temperature by improving the SERVOPACK installation conditions.	*1
	An overload alarm was reset by turning OFF the power supply too many times.	Check the alarm display to see if there is an overload alarm.	Change the method for resetting the alarm.	–
	There was an excessive load or operation was performed that exceeded the regenerative processing capacity.	Use the accumulated load ratio to check the load during operation, and use the regenerative load ratio to check the regenerative processing capacity.	Reconsider the load and operating conditions.	–
	The SERVOPACK installation orientation is not correct or there is insufficient space around the SERVOPACK.	Check the SERVOPACK installation conditions.	Install the SERVOPACK according to specifications.	*1
	A failure occurred in the SERVOPACK.	–	The SERVOPACK may be faulty. Replace the SERVOPACK.	–
A.7A2: Internal Temperature Error 2 (Power Board Temperature Error)	The surrounding temperature is too high.	Check the surrounding temperature using a thermostat. Or, check the operating status with the SERVOPACK installation environment monitor.	Decrease the surrounding temperature by improving the SERVOPACK installation conditions.	*1
	An overload alarm was reset by turning OFF the power supply too many times.	Check the alarm display to see if there is an overload alarm.	Change the method for resetting the alarm.	–
	There was an excessive load or operation was performed that exceeded the regenerative processing capacity.	Use the accumulated load ratio to check the load during operation, and use the regenerative load ratio to check the regenerative processing capacity.	Reconsider the load and operating conditions.	–
	The SERVOPACK installation orientation is not correct or there is insufficient space around the SERVOPACK.	Check the SERVOPACK installation conditions.	Install the SERVOPACK according to specifications.	*1
	A failure occurred in the SERVOPACK.	–	The SERVOPACK may be faulty. Replace the SERVOPACK.	–
A.7A3: Internal Temperature Sensor Error (An error occurred in the temperature sensor circuit.)	A failure occurred in the SERVOPACK.	–	The SERVOPACK may be faulty. Replace the SERVOPACK.	–

Continued on next page.

4.1 SERVOPACKs with Analog Voltage/Pulse Train References

4.1.3 Troubleshooting Alarms

Continued from previous page.

Alarm Number: Alarm Name	Possible Cause	Confirmation	Correction	Reference
A.7Ab: SERVOPACK Built-in Fan Stopped	The fan inside the SERVOPACK stopped.	Check for foreign matter inside the SERVOPACK.	Remove foreign matter from the SERVOPACK. If an alarm still occurs, the SERVOPACK may be faulty. Replace the SERVOPACK.	–
A.810: Encoder Backup Alarm (Detected at the encoder, but only when an absolute encoder is used.)	The power to the absolute encoder was turned ON for the first time.	Check to see if the power supply was turned ON for the first time.	Set up the encoder.	*1
	The Encoder Cable was disconnected and then connected again.	Check to see if the power supply was turned ON for the first time.	Check the encoder connection and set up the encoder.	*1
	Power is not being supplied both from the control power supply (+5 V) from the SERVOPACK and from the battery power supply.	Check the encoder connector battery and the connector status.	Replace the battery or implement similar measures to supply power to the encoder, and set up the encoder.	*1
	A failure occurred in the absolute encoder.	–	If the alarm still occurs after setting up the encoder again, replace the Servomotor.	–
A.820: Encoder Check-sum Alarm (Detected at the encoder.)	A failure occurred in the encoder.	–	<ul style="list-style-type: none"> ■ When Using an Absolute Encoder Set up the encoder again. If the alarm still occurs, the Servomotor may be faulty. Replace the Servomotor. ■ When Using a Single-turn Absolute Encoder or Incremental Encoder <ul style="list-style-type: none"> • The Servomotor may be faulty. Replace the Servomotor. • The linear encoder may be faulty. Replace the linear encoder. 	*1
	A failure occurred in the SERVOPACK.	–	The SERVOPACK may be faulty. Replace the SERVOPACK.	–
A.830: Encoder Battery Alarm (The absolute encoder battery voltage was lower than the specified level.)	The battery connection is faulty or a battery is not connected.	Check the battery connection.	Correct the battery connection.	*1
	The battery voltage is lower than the specified value (2.7 V).	Measure the battery voltage.	Replace the battery.	*1
	A failure occurred in the SERVOPACK.	–	The SERVOPACK may be faulty. Replace the SERVOPACK.	–

Continued on next page.

Continued from previous page.

Alarm Number: Alarm Name	Possible Cause	Confirmation	Correction	Reference
A.840: Encoder Data Alarm (Detected at the encoder.)	The encoder malfunctioned.	–	Turn the power supply to the SERVOPACK OFF and ON again. If an alarm still occurs, the Servomotor or linear encoder may be faulty. Replace the Servomotor or linear encoder.	–
	An error occurred in reading data from the linear encoder.	–	The linear encoder is not mounted within an appropriate tolerance. Correct the mounting of the linear encoder.	–
	Excessive speed occurred in the linear encoder.	–	Control the motor speed within the range specified by the linear encoder manufacturer and then turn ON the control power supply.	–
	The encoder malfunctioned due to noise.	–	Correct the wiring around the encoder by separating the Encoder Cable from the Servomotor Main Circuit Cable or by grounding the encoder.	–
	The polarity sensor is not wired correctly.	Check the wiring of the polarity sensor.	Correct the wiring of the polarity sensor.	–
	The polarity sensor failed.	–	Replace the polarity sensor.	–
A.850: Encoder Over-speed (Detected at the encoder when the control power supply is turned ON.)	Rotary Servomotor: The Servomotor speed was 200 min^{-1} or higher when the control power supply was turned ON.	Check the motor speed when the power supply is turned ON.	Reduce the Servomotor speed to a value less than 200 min^{-1} , and turn ON the control power supply.	–
	Linear Servomotor: The Servomotor exceeded the specified speed when the control power supply was turned ON.	Check the motor speed when the power supply is turned ON.	Control the motor speed within the range specified by the linear encoder manufacturer and then turn ON the control power supply.	–
	A failure occurred in the encoder.	–	Turn the power supply to the SERVOPACK OFF and ON again. If an alarm still occurs, the Servomotor or linear encoder may be faulty. Replace the Servomotor or linear encoder.	–
	A failure occurred in the SERVOPACK.	–	Turn the power supply to the SERVOPACK OFF and ON again. If an alarm still occurs, the SERVOPACK may be faulty. Replace the SERVOPACK.	–

Continued on next page.

4.1 SERVOPACKs with Analog Voltage/Pulse Train References

4.1.3 Troubleshooting Alarms

Continued from previous page.

Alarm Number: Alarm Name	Possible Cause	Confirmation	Correction	Reference
A.860: Encoder Overheated (Detected at the encoder, but only when an absolute encoder is used.)	The surrounding air temperature around the Servomotor is too high.	Measure the surrounding air temperature around the Servomotor.	Reduce the surrounding air temperature of the Servomotor to 40°C or less.	-
	The Servomotor load is greater than the rated load.	Use the accumulated load ratio to check the load.	Operate the Servo Drive so that the motor load remains within the specified range.	*1
	A failure occurred in the encoder.	-	Turn the power supply to the SERVOPACK OFF and ON again. If an alarm still occurs, the Servomotor or absolute linear encoder may be faulty. Replace the Servomotor or absolute linear encoder.	-
	A failure occurred in the SERVOPACK.	-	Turn the power supply to the SERVOPACK OFF and ON again. If an alarm still occurs, the SERVOPACK may be faulty. Replace the SERVOPACK.	-
A.861: Motor Overheated	The surrounding temperature around the Servomotor is too high.	Measure the surrounding temperature around the Servomotor.	Reduce the surrounding air temperature of the Servomotor to 40° or less.	-
	The motor load is greater than the rated load.	Check the load with the accumulated load ratio on the Motion Monitor Tab Page on the SigmaWin+.	Operate the Servo Drive so that the motor load remains within the specified range.	*1
	A failure occurred in the Serial Converter Unit.	-	Turn the power supply to the SERVOPACK OFF and ON again. If an alarm still occurs, the Serial Converter Unit may be faulty. Replace the Serial Converter Unit.	-
	A failure occurred in the SERVOPACK.	-	Turn the power supply to the SERVOPACK OFF and ON again. If an alarm still occurs, the SERVOPACK may be faulty. Replace the SERVOPACK.	-
A.890: Encoder Scale Error	A failure occurred in the linear encoder.	-	The linear encoder may be faulty. Replace the linear encoder.	-
A.891: Encoder Module Error	A failure occurred in the linear encoder.	-	Turn the power supply to the SERVOPACK OFF and ON again. If an alarm still occurs, the linear encoder may be faulty. Replace the linear encoder.	-
A.8A0: External Encoder Error	Setting the origin of the absolute linear encoder failed because the motor moved.	Before you set the origin, use the fully-closed feedback pulse counter to confirm that the motor is not moving.	The motor must be stopped while setting the origin position.	*1
	A failure occurred in the external encoder.	-	Replace the external encoder.	-

Continued on next page.

Continued from previous page.

Alarm Number: Alarm Name	Possible Cause	Confirmation	Correction	Reference
A.8A1: External Encoder Module Error	A failure occurred in the external encoder.	–	Replace the external encoder.	–
	A failure occurred in the Serial Converter Unit.	–	Replace the Serial Converter Unit.	–
A.8A2: External Incremental Encoder Sensor Error	A failure occurred in the external encoder.	–	Replace the external encoder.	–
A.8A3: External Absolute Encoder Position Error	A failure occurred in the external absolute encoder.	–	The external absolute encoder may be faulty. Refer to the encoder manufacturer's instruction manual for corrections.	–
A.8A5: External Encoder Overspeed	An overspeed error was detected in the external encoder.	Check the maximum speed of the external encoder.	Keep the external encoder below its maximum speed.	–
A.8A6: External Encoder Overheated	An overheating error was detected in the external encoder.	–	Replace the external encoder.	–
A.b10: Speed Reference A/D Error (Detected when the servo is turned ON.)	A malfunction occurred in the speed reference input section.	–	Reset the alarm and restart operation.	*1
	A failure occurred in the SERVOPACK.	–	Turn the power supply to the SERVOPACK OFF and ON again. If an alarm still occurs, the SERVOPACK may be faulty. Replace the SERVOPACK.	–
A.b11: Speed Reference A/D Data Error	A malfunction occurred in the speed reference input section.	–	Reset the alarm and restart operation.	*1
	A failure occurred in the SERVOPACK.	–	Turn the power supply to the SERVOPACK OFF and ON again. If an alarm still occurs, the SERVOPACK may be faulty. Replace the SERVOPACK.	–
A.b20: Torque Reference A/D Error (Detected when the servo is turned ON.)	A malfunction occurred in the reading section for the torque reference input.	–	Reset the alarm and restart operation.	*1
	A failure occurred in the SERVOPACK.	–	Turn the power supply to the SERVOPACK OFF and ON again. If an alarm still occurs, the SERVOPACK may be faulty. Replace the SERVOPACK.	–
A.b33: Current Detection Error 3	A failure occurred in the current detection circuit.	–	Turn the power supply to the SERVOPACK OFF and ON again. If an alarm still occurs, the SERVOPACK may be faulty. Replace the SERVOPACK.	–

Continued on next page.

4.1 SERVOPACKs with Analog Voltage/Pulse Train References

4.1.3 Troubleshooting Alarms

Continued from previous page.

Alarm Number: Alarm Name	Possible Cause	Confirmation	Correction	Reference
A.bF0: System Alarm 0	A failure occurred in the SERVOPACK.	—	Turn the power supply to the SERVOPACK OFF and ON again. If an alarm still occurs, the SERVOPACK may be faulty. Replace the SERVOPACK.	—
A.bF1: System Alarm 1	A failure occurred in the SERVOPACK.	—	Turn the power supply to the SERVOPACK OFF and ON again. If an alarm still occurs, the SERVOPACK may be faulty. Replace the SERVOPACK.	—
A.bF2: System Alarm 2	A failure occurred in the SERVOPACK.	—	Turn the power supply to the SERVOPACK OFF and ON again. If an alarm still occurs, the SERVOPACK may be faulty. Replace the SERVOPACK.	—
A.bF3: System Alarm 3	A failure occurred in the SERVOPACK.	—	Turn the power supply to the SERVOPACK OFF and ON again. If an alarm still occurs, the SERVOPACK may be faulty. Replace the SERVOPACK.	—
A.bF4: System Alarm 4	A failure occurred in the SERVOPACK.	—	Turn the power supply to the SERVOPACK OFF and ON again. If an alarm still occurs, the SERVOPACK may be faulty. Replace the SERVOPACK.	—
A.C10: Servomotor Out of Control (Detected when the servo is turned ON.)	The order of phases U, V, and W in the motor wiring is not correct.	Check the Servomotor wiring.	Make sure that the Servomotor is correctly wired.	—
	There is an error in the setting of Pn080 = n.□□X□ (Motor Phase Sequence Selection).	Check the setting of Pn080 = n.□□X□.	Set Pn080 = n.□□X□ to an appropriate value.	*1
	A failure occurred in the encoder.	—	If the motor wiring is correct and an alarm still occurs after turning the power supply OFF and ON again, the Servomotor or linear encoder may be faulty. Replace the Servomotor or linear encoder.	—
	A failure occurred in the SERVOPACK.	—	Turn the power supply to the SERVOPACK OFF and ON again. If an alarm still occurs, the SERVOPACK may be faulty. Replace the SERVOPACK.	—

Continued on next page.

Continued from previous page.

Alarm Number: Alarm Name	Possible Cause	Confirmation	Correction	Reference
A.C20: Phase Detection Error	The linear encoder signal level is too low.	Check the voltage of the linear encoder signal.	Fine-tune the mounting of the scale head. Or, replace the linear encoder.	–
	The count-up direction of the linear encoder does not match the forward direction of the Moving Coil in the motor.	Check the setting of Pn080 = n.□□X□ (Motor Phase Sequence Selection). Check the installation orientation for the linear encoder and Moving Coil.	Change the setting of Pn080 = n.□□X□. Correctly reinstall the linear encoder or Moving Coil.	*1
	The polarity sensor signal is being affected by noise.	–	Correct the FG wiring. Implement countermeasures against noise for the polarity sensor wiring.	–
A.C21: Polarity Sensor Error	The polarity sensor is protruding from the Magnetic Way of the motor.	Check the polarity sensor.	Correctly reinstall the Moving Coil or Magnetic Way of the motor.	–
	The setting of Pn282 (Linear Encoder Scale Pitch) is not correct.	Check the setting of Pn282 (Linear Encoder Scale Pitch).	Check the specifications of the linear encoder and set a correct value.	*1
	The polarity sensor is not wired correctly.	Check the wiring of the polarity sensor.	Correct the wiring of the polarity sensor.	–
	The polarity sensor failed.	–	Replace the polarity sensor.	–
A.C22: Phase Information Disagreement	The SERVOPACK phase information is different from the linear encoder phase information.	–	Perform polarity detection.	*1

Continued on next page.

Continued from previous page.

Alarm Number: Alarm Name	Possible Cause	Confirmation	Correction	Reference
A.C50: Polarity Detection Failure	The parameter settings are not correct.	Check the linear encoder specifications and feedback signal status.	The settings of Pn282 (Linear Encoder Scale Pitch) and Pn080 = n.□□X□ (Motor Phase Sequence Selection) may not match the installation. Set the parameters to correct values.	*1
	There is noise on the scale signal.	Check to make sure that the frame grounds of the Serial Converter Unit and Servomotor are connected to the FG terminal on the SERVOPACK and that the FG terminal on the SERVOPACK is connected to the frame ground on the power supply. And, confirm that the shield is properly processed on the Linear Encoder Cable. Check to see if the detection reference is repeatedly output in one direction.	Implement appropriate countermeasures against noise for the Linear Encoder Cable.	-
	An external force was applied to the Moving Coil of the motor.	-	The polarity cannot be properly detected if the detection reference is 0 and the speed feedback is not 0 because of an external force, such as cable tension, applied to the Moving Coil. Implement measures to reduce the external force so that the speed feedback goes to 0. If the external force cannot be reduced, increase the setting of Pn481 (Polarity Detection Speed Loop Gain).	-
	The linear encoder resolution is too low.	Check the linear encoder scale pitch to see if it is within 100 μm.	If the linear encoder scale pitch is 100 μm or higher, the SERVOPACK cannot detect the correct speed feedback. Use a linear encoder scale pitch with higher resolution. (We recommend a pitch of 40 μm or less.) Or, increase the setting of Pn485 (Polarity Detection Reference Speed). However, increasing the setting of Pn485 will increase the Servomotor movement range that is required for polarity detection.	-

Continued on next page.

Continued from previous page.

Alarm Number: Alarm Name	Possible Cause	Confirmation	Correction	Reference
A.C51: Overtravel Detected during Polarity Detection	The overtravel signal was detected during polarity detection.	Check the overtravel position.	Wire the overtravel signals. Execute polarity detection at a position where an overtravel signal would not be detected.	*1
A.C52: Polarity Detection Not Completed	The servo was turned ON under the following circumstances. <ul style="list-style-type: none"> • Before polarity detection was completed • Before /P-DET was input 	–	Input the /P-DET signal.	*1
A.C53: Out of Range of Motion for Polarity Detection	The travel distance exceeded the setting of Pn48E (Polarity Detection Range) in the middle of detection.	–	Increase the setting of Pn48E (Polarity Detection Range). Or, increase the setting of Pn481 (Polarity Detection Speed Loop Gain).	–
A.C54: Polarity Detection Failure 2	An external force was applied to the Servomotor.	–	Increase the setting of Pn495 (Polarity Detection Confirmation Force Reference). Increase the setting of Pn498 (Polarity Detection Allowable Error Range). Increasing the allowable error will also increase the motor temperature.	–
A.C80: Encoder Clear Error or Multiturn Limit Setting Error	A failure occurred in the encoder.	–	Turn the power supply to the SERVOPACK OFF and ON again. If an alarm still occurs, the Servomotor or linear encoder may be faulty. Replace the Servomotor or linear encoder.	–
	A failure occurred in the SERVOPACK.	–	Turn the power supply to the SERVOPACK OFF and ON again. If an alarm still occurs, the SERVOPACK may be faulty. Replace the SERVOPACK.	–

Continued on next page.

4.1 SERVOPACKs with Analog Voltage/Pulse Train References

4.1.3 Troubleshooting Alarms

Continued from previous page.

Alarm Number: Alarm Name	Possible Cause	Confirmation	Correction	Reference
A.C90: Encoder Commu- nications Error	There is a faulty contact in the connector or the connector is not wired correctly for the encoder.	Check the condition of the encoder connector.	Reconnect the encoder connector and check the encoder wiring.	*1
	There is a cable disconnection or short-circuit in the encoder. Or, the cable impedance is outside the specified values.	Check the condition of the Encoder Cable.	Use the Encoder Cable within the specified specifications.	-
	One of the following has occurred: corrosion caused by improper temperature, humidity, or gas, a short-circuit caused by entry of water drops or cutting oil, or faulty contact in connector caused by vibration.	Check the operating environment.	Improve the operating environmental, and replace the cable. If the alarm still occurs, replace the SERVOPACK.	*1
	A malfunction was caused by noise.	-	Correct the wiring around the encoder by separating the Encoder Cable from the Servomotor Main Circuit Cable or by grounding the encoder.	*1
	A failure occurred in the SERVOPACK.	-	Connect the Servomotor to another SERVOPACK, and turn ON the control power supply. If no alarm occurs, the SERVOPACK may be faulty. Replace the SERVOPACK.	-
A.C91: Encoder Commu- nications Posi- tion Data Acceleration Rate Error	Noise entered on the signal lines because the Encoder Cable is bent or the sheath is damaged.	Check the condition of the Encoder Cable and connectors.	Check the Encoder Cable to see if it is installed correctly.	*1
	The Encoder Cable is bundled with a high-current line or installed near a high-current line.	Check the installation condition of the Encoder Cable.	Confirm that there is no surge voltage on the Encoder Cable.	-
	There is variation in the FG potential because of the influence of machines on the Servomotor side, such as a welder.	Check the installation condition of the Encoder Cable.	Properly ground the machine to separate it from the FG of the encoder.	-

Continued on next page.

Continued from previous page.

Alarm Number: Alarm Name	Possible Cause	Confirmation	Correction	Reference
A.C92: Encoder Commu- nications Timer Error	Noise entered on the signal line from the encoder.	–	Implement countermeasures against noise for the encoder wiring.	*1
	Excessive vibration or shock was applied to the encoder.	Check the operating conditions.	Reduce machine vibration. Correctly install the Servomotor or linear encoder.	–
	A failure occurred in the encoder.	–	Turn the power supply to the SERVOPACK OFF and ON again. If an alarm still occurs, the Servomotor or linear encoder may be faulty. Replace the Servomotor or linear encoder.	–
	A failure occurred in the SERVOPACK.	–	Turn the power supply to the SERVOPACK OFF and ON again. If an alarm still occurs, the SERVOPACK may be faulty. Replace the SERVOPACK.	–
A.CA0: Encoder Parame- ter Error	A failure occurred in the encoder.	–	Turn the power supply to the SERVOPACK OFF and ON again. If an alarm still occurs, the Servomotor or linear encoder may be faulty. Replace the Servomotor or linear encoder.	–
	A failure occurred in the SERVOPACK.	–	Turn the power supply to the SERVOPACK OFF and ON again. If an alarm still occurs, the SERVOPACK may be faulty. Replace the SERVOPACK.	–

Continued on next page.

4.1 SERVOPACKs with Analog Voltage/Pulse Train References

4.1.3 Troubleshooting Alarms

Continued from previous page.

Alarm Number: Alarm Name	Possible Cause	Confirmation	Correction	Reference
A.Cb0: Encoder Echo- back Error	The encoder is wired incorrectly or there is faulty contact.	Check the wiring of the encoder.	Make sure that the encoder is correctly wired.	*1
	The specifications of the Encoder Cable are not correct and noise entered on it.	–	Use a shielded twisted-pair wire cable or a screened twisted-pair cable with conductors of at least 0.12 mm ² .	–
	The Encoder Cable is too long and noise entered on it.	–	<ul style="list-style-type: none"> Rotary Servomotors: The Encoder Cable wiring distance must be 50 m max. Linear Servomotors: The Encoder Cable wiring distance must be 20 m max. 	–
	There is variation in the FG potential because of the influence of machines on the Servomotor side, such as a welder.	Check the condition of the Encoder Cable and connectors.	Properly ground the machine to separate it from the FG of the encoder.	–
	Excessive vibration or shock was applied to the encoder.	Check the operating conditions.	Reduce machine vibration. Correctly install the Servomotor or linear encoder.	–
	A failure occurred in the encoder.	–	Turn the power supply to the SERVOPACK OFF and ON again. If an alarm still occurs, the Servomotor or linear encoder may be faulty. Replace the Servomotor or linear encoder.	–
	A failure occurred in the SERVOPACK.	–	Turn the power supply to the SERVOPACK OFF and ON again. If an alarm still occurs, the SERVOPACK may be faulty. Replace the SERVOPACK.	–
A.CC0: Multiturn Limit Disagreement	When using a Direct Drive Servomotor, the setting of Pn205 (Multiturn Limit) does not agree with the encoder.	Check the setting of Pn205.	Correct the setting of Pn205 (0 to 65,535).	*1
	The multiturn limit of the encoder is different from that of the SERVOPACK. Or, the multiturn limit of the SERVOPACK has been changed.	Check the setting of Pn205 in the SERVOPACK.	Change the setting if the alarm occurs.	*1
	A failure occurred in the SERVOPACK.	–	Turn the power supply to the SERVOPACK OFF and ON again. If an alarm still occurs, the SERVOPACK may be faulty. Replace the SERVOPACK.	–

Continued on next page.

Continued from previous page.

Alarm Number: Alarm Name	Possible Cause	Confirmation	Correction	Reference
A.CF1: Reception Failed Error in Feed- back Option Module Commu- nications	The cable between the Serial Converter Unit and SERVOPACK is not wired correctly or there is a faulty contact.	Check the wiring of the external encoder.	Correctly wire the cable between the Serial Converter Unit and SERVOPACK.	*1
	A specified cable is not being used between Serial Converter Unit and SERVOPACK.	Check the wiring specifications of the external encoder.	Use a specified cable.	-
	The cable between the Serial Converter Unit and SERVOPACK is too long.	Measure the length of the cable that connects the Serial Converter Unit.	The length of the cable between the Serial Converter Unit and SERVOPACK must be 20 m or less.	-
	The sheath on cable between the Serial Converter Unit and SERVOPACK is broken.	Check the cable that connects the Serial Converter Unit.	Replace the cable between the Serial Converter Unit and SERVOPACK.	-
A.CF2: Timer Stopped Error in Feed- back Option Module Commu- nications	Noise entered the cable between the Serial Converter Unit and SERVOPACK.	-	Correct the wiring around the Serial Converter Unit, e.g., separate I/O signal lines from the Main Circuit Cables or ground.	-
	A failure occurred in the Serial Converter Unit.	-	Replace the Serial Converter Unit.	-
	A failure occurred in the SERVOPACK.	-	Replace the SERVOPACK.	-
A.d00: Position Devia- tion Overflow (The setting of Pn520 (Position Deviation Over- flow Alarm Level) was exceeded by the position deviation while the servo was ON.)	The Servomotor U, V, and W wiring is not correct.	Check the wiring of the Servomotor's Main Circuit Cables.	Make sure that there are no faulty contacts in the wiring for the Servomotor and encoder.	-
	The frequency of the position reference pulse is too high.	Reduce the reference pulse frequency and try operating the SERVOPACK.	Reduce the position reference pulse frequency or the reference acceleration rate, or reconsider the electronic gear ratio.	*1
	The acceleration of the position reference is too high.	Reduce the reference acceleration and try operating the SERVOPACK.	Apply smoothing, i.e., by using Pn216 (Position Reference Acceleration/Deceleration Time Constant).	*1
	The setting of Pn520 (Position Deviation Overflow Alarm Level) is too low for the operating conditions.	Check Pn520 (Position Deviation Overflow Alarm Level) to see if it is set to an appropriate value.	Optimize the setting of Pn520.	*1
	A failure occurred in the SERVOPACK.	-	Turn the power supply to the SERVOPACK OFF and ON again. If an alarm still occurs, the SERVOPACK may be faulty. Replace the SERVOPACK.	-

Continued on next page.

4.1 SERVOPACKs with Analog Voltage/Pulse Train References

4.1.3 Troubleshooting Alarms

Continued from previous page.

Alarm Number: Alarm Name	Possible Cause	Confirmation	Correction	Reference
A.d01: Position Deviation Overflow Alarm at Servo ON	The servo was turned ON after the position deviation exceeded the setting of Pn526 (Position Deviation Overflow Alarm Level at Servo ON) while the servo was OFF.	Check the position deviation while the servo is OFF.	Set the position deviation to be cleared while the servo is OFF. Optimize the setting of Pn526 (Position Deviation Overflow Alarm Level at Servo ON).	*1
A.d02: Position Deviation Overflow Alarm for Speed Limit at Servo ON	If position deviation remains in the deviation counter, the setting of Pn529 or Pn584 (Speed Limit Level at Servo ON) limits the speed when the servo is turned ON. This alarm occurs if reference pulses are input and the setting of Pn520 (Position Deviation Overflow Alarm Level) is exceeded.	–	Set the position deviation to be cleared while the servo is OFF. Optimize the setting of Pn520 (Position Deviation Overflow Alarm Level). Or, adjust the setting of Pn529 or Pn584 (Speed Limit Level at Servo ON).	*1
A.d10: Motor-Load Position Deviation Overflow	The motor direction and external encoder installation orientation are backward.	Check the motor direction and the external encoder installation orientation.	Install the external encoder in the opposite direction, or change the setting of Pn002 = n.X□□□ (External Encoder Usage) to reverse the direction.	*1
	There is an error in the connection between the load (e.g., stage) and external encoder coupling.	Check the coupling of the external encoder.	Check the mechanical coupling.	–
A.d30: Position Data Overflow	The position data exceeded $\pm 1,879,048,192$.	Check the input reference pulse counter.	Reconsider the operating specifications.	–
A.E71: Safety Option Module Detection Failure	There is a faulty connection between the SERVOPACK and the Safety Option Module.	Check the connection between the SERVOPACK and the Safety Option Module.	Correctly connect the Safety Option Module.	–
	The Safety Option Module was disconnected.	–	Execute Fn014 (Reset Option Module Configuration Error) from the Digital Operator or SigmaWin+ and then turn the power supply to the SERVOPACK OFF and ON again.	*1
	A failure occurred in the Safety Option Module.	–	Replace the Safety Option Module.	–
	A failure occurred in the SERVOPACK.	–	Replace the SERVOPACK.	–

Continued on next page.

Continued from previous page.

Alarm Number: Alarm Name	Possible Cause	Confirmation	Correction	Reference
A.E72: Feedback Option Module Detection Failure	There is a faulty connection between the SERVOPACK and the Feedback Option Module.	Check the connection between the SERVOPACK and the Feedback Option Module.	Correctly connect the Feedback Option Module.	–
	The Feedback Option Module was disconnected.	–	Reset the Option Module configuration error and turn the power supply to the SERVOPACK OFF and ON again.	*1
	A failure occurred in the Feedback Option Module.	–	Replace the Feedback Option Module.	–
	A failure occurred in the SERVOPACK.	–	Replace the SERVOPACK.	–
A.E74: Unsupported Safety Option Module	A failure occurred in the Safety Option Module.	–	Replace the Safety Option Module.	–
	An unsupported Safety Option Module was connected.	Refer to the catalog of the connected Safety Option Module.	Connect a compatible Safety Option Module.	–
A.Eb1: Safety Function Signal Input Timing Error	The delay between activation of the /HWBB1 and /HWBB2 input signals for the HWBB was ten second or longer.	Measure the time delay between the /HWBB1 and /HWBB2 signals.	The output signal circuits or devices for /HWBB1 and /HWBB2 or the SERVOPACK input signal circuits may be faulty. Alternatively, the input signal cables may be disconnected. Check to see if any of these items are faulty or have been disconnected.	–
	A failure occurred in the SERVOPACK.	–	Replace the SERVOPACK.	–
A.EC8: Gate Drive Error 1 (An error occurred in the gate drive circuit.)	A failure occurred in the SERVOPACK.	–	Turn the power supply to the SERVOPACK OFF and ON again. If an alarm still occurs, the SERVOPACK may be faulty. Replace the SERVOPACK.	–
A.EC9: Gate Drive Error 2 (An error occurred in the gate drive circuit.)				

Continued on next page.

4.1 SERVOPACKs with Analog Voltage/Pulse Train References

4.1.3 Troubleshooting Alarms

Continued from previous page.

Alarm Number: Alarm Name	Possible Cause	Confirmation	Correction	Reference
A.F10: Power Supply Line Open Phase (The voltage was low for more than one second for phase R, S, or T when the main power supply was ON.)	The three-phase power supply wiring is not correct.	Check the power supply wiring.	Make sure that the power supply is correctly wired.	*1
	The three-phase power supply is unbalanced.	Measure the voltage for each phase of the three-phase power supply.	Balance the power supply by changing phases.	–
	A single-phase power supply was input without specifying a signal-phase AC power supply input (Pn00B = n.□1□□).	Check the power supply and the parameter setting.	Match the parameter setting to the power supply.	*1
	A failure occurred in the SERVOPACK.	–	Turn the power supply to the SERVOPACK OFF and ON again. If an alarm still occurs, the SERVOPACK may be faulty. Replace the SERVOPACK.	–
A.F50: Servomotor Main Circuit Cable Disconnection (The Servomotor did not operate or power was not supplied to the Servomotor even though the /S-ON (Servo ON) signal was input when the Servomotor was ready to receive it.)	A failure occurred in the SERVOPACK.	–	The SERVOPACK may be faulty. Replace the SERVOPACK.	–
	The wiring is not correct or there is a faulty contact in the motor wiring.	Check the wiring.	Make sure that the Servomotor is correctly wired.	*1
FL-1*5: System Alarm	A failure occurred in the SERVOPACK.	–	Turn the power supply to the SERVOPACK OFF and ON again. If an alarm still occurs, the SERVOPACK may be faulty. Replace the SERVOPACK.	–
FL-2*5: System Alarm				
FL-3*5: System Alarm				
FL-4*5: System Alarm				
FL-5*5: System Alarm				
CPF00: Digital Operator Communications Error 1	There is a faulty contact between the Digital Operator and the SERVOPACK.	Check the connector contact.	Disconnect the connector and insert it again. Or, replace the cable.	–
	A malfunction was caused by noise.	–	Keep the Digital Operator or the cable away from sources of noise.	–

Continued on next page.

Continued from previous page.

Alarm Number: Alarm Name	Possible Cause	Confirmation	Correction	Reference
CPF01: Digital Operator Communications Error 2	A failure occurred in the Digital Operator.	—	Disconnect the Digital Operator and then connect it again. If an alarm still occurs, the Digital Operator may be faulty. Replace the Digital Operator.	—
	A failure occurred in the SERVOPACK.	—	Turn the power supply to the SERVOPACK OFF and ON again. If an alarm still occurs, the SERVOPACK may be faulty. Replace the SERVOPACK.	—

*1. Refer to the following manual for details.

 Σ -7-Series Σ -7S SERVOPACK with Analog Voltage/Pulse Train References Product Manual (Manual No.: SIEP S800001 26)

*2. Detection Conditions

• Rotary Servomotor

If either of the following conditions is detected, an alarm will occur.

$$\bullet \text{ Pn533 [min}^{-1}\text{]} \times \frac{\text{Encoder resolution}}{6 \times 10^5} \leq \frac{\text{Pn20E}}{\text{Pn210}}$$

$$\bullet \text{ Maximum motor speed [min}^{-1}\text{]} \times \frac{\text{Encoder resolution}}{\text{Approx. } 3.66 \times 10^{12}} \geq \frac{\text{Pn20E}}{\text{Pn210}}$$

• Linear Servomotor

If either of the following conditions is detected, an alarm will occur.

$$\bullet \frac{\text{Pn585 [mm/s]}}{\text{Linear encoder pitch [\mu m]}} \times \frac{\text{Resolution of Serial Converter Unit}}{10} \leq \frac{\text{Pn20E}}{\text{Pn210}}$$

$$\bullet \frac{\text{Pn385 [100 mm/s]}}{\text{Linear encoder pitch [\mu m]}} \times \frac{\text{Resolution of Serial Converter Unit}}{\text{Approx. } 6.10 \times 10^5} \geq \frac{\text{Pn20E}}{\text{Pn210}}$$

*3. Detection Conditions

• Rotary Servomotor

If either of the following conditions is detected, an alarm will occur.

$$\bullet \text{ Rated motor speed [min}^{-1}\text{]} \times 1/3 \times \frac{\text{Encoder resolution}}{6 \times 10^5} \leq \frac{\text{Pn20E}}{\text{Pn210}}$$

$$\bullet \text{ Maximum motor speed [min}^{-1}\text{]} \times \frac{\text{Encoder resolution}}{\text{Approx. } 3.66 \times 10^{12}} \geq \frac{\text{Pn20E}}{\text{Pn210}}$$

• Linear Servomotor

If either of the following conditions is detected, an alarm will occur.

$$\bullet \frac{\text{Rated motor speed [mm/s]} \times 1/3}{\text{Linear encoder pitch [\mu m]}} \times \frac{\text{Resolution of Serial Converter Unit}}{10} \leq \frac{\text{Pn20E}}{\text{Pn210}}$$

$$\bullet \frac{\text{Pn385 [100 mm/s]}}{\text{Linear encoder pitch [\mu m]}} \times \frac{\text{Resolution of Serial Converter Unit}}{\text{Approx. } 6.10 \times 10^5} \geq \frac{\text{Pn20E}}{\text{Pn210}}$$

*4. Refer to the following manual for details.

 Σ -7-Series Peripheral Device Selection Manual (Manual No.: SIEP S800001 32)

*5. These alarms are not stored in the alarm history. They are only displayed on the panel display.

4.1.4 Warning Displays

If a warning occurs in the SERVOPACK, a warning number will be displayed on the panel display. Warnings are displayed to warn you before an alarm occurs.

4.1.5 List of Warnings

The list of warnings gives the warning name, warning meaning, and warning code output in order of the warning numbers.

Warning Number	Warning Name	Meaning	Warning Code Output		
			ALO1	ALO2	ALO3
A.900	Position Deviation Overflow	The position deviation exceeded the parameter settings (Pn520 × Pn51E/100).	H	H	H
A.901	Position Deviation Overflow Alarm at Servo ON	The position deviation exceeded the parameter settings (Pn526 × Pn528/100) when the servo was turned ON.	H	H	H
A.910	Overload	This warning occurs before an overload alarm (A.710 or A.720) occurs. If the warning is ignored and operation is continued, an alarm may occur.	L	H	H
A.911	Vibration	Abnormal vibration was detected during motor operation. The detection level is the same as A.520. Set whether to output an alarm or a warning by setting Pn310 (Vibration Detection Selections).	L	H	H
A.912	Internal Temperature Warning 1 (Control Board Temperature Error)	The surrounding temperature of the control PCB is abnormal.	H	L	H
A.913	Internal Temperature Warning 2 (Power Board Temperature Error)	The surrounding temperature of the power PCB is abnormal.	H	L	H
A.920	Regenerative Overload	This warning occurs before an A.320 alarm (Regenerative Overload) occurs. If the warning is ignored and operation is continued, an alarm may occur.	H	L	H
A.921	Dynamic Brake Overload	This warning occurs before an A.731 alarm (Dynamic Brake Overload) occurs. If the warning is ignored and operation is continued, an alarm may occur.	H	L	H
A.923	SERVOPACK Built-in Fan Stopped	The fan inside the SERVOPACK stopped.	H	L	H
A.930	Absolute Encoder Battery Error	This warning occurs when the voltage of absolute encoder's battery is low.	L	L	H
A.941	Change of Parameters Requires Restart	Parameters have been changed that require the power supply to be turned OFF and ON again.	H	H	L
A.942	Speed Ripple Compensation Information Disagreement	The speed ripple compensation information stored in the encoder does not agree with the speed ripple compensation information stored in the SERVOPACK.	H	H	L
A.971	Undervoltage	This warning occurs before an A.410 alarm (Undervoltage) occurs. If the warning is ignored and operation is continued, an alarm may occur.	L	L	L
A.9A0	Overtravel	Overtravel was detected while the servo was ON.	H	L	L
A.9b0	Preventative Maintenance Warning	One of the consumable parts has reached the end of its service life.	H	L	H

- Note: 1. A warning code is not output unless you set Pn001 to n.1□□□ (Output both alarm codes and warning codes).
2. Use Pn008 = n.□X□□ (Warning Detection Selection) to control warning detection. However, the following warnings are not affected by the setting of Pn008 = n.□X□□ and other parameter settings are required in addition to Pn008 = n.□X□□.

Warning	Parameters That Must Be Set to Select Warning Detection
A.911	Pn310 = n.□□□X (Vibration Detection Selection)
A.923	– (Not affected by the setting of Pn008 = n.□X□□.)
A.930	Pn008 = n.□□□X (Low Battery Voltage Alarm/Warning Selection)
A.942	Pn423 = n.□□□□ (Speed Ripple Compensation Information Disagreement Warning Detection Selection)
A.971	Pn008 = n.□□□X (Low Battery Voltage Alarm/Warning Selection) (Not affected by the setting of Pn008 = n.□X□□.)
A.9A0	Pn00D = n.X□□□ (Overtravel Warning Detection Selection) (Not affected by the setting of Pn008 = n.□X□□.)
A.9b0	Pn00F = n.□□□X (Preventative Maintenance Warning Selection)

4.1.6 Troubleshooting Warnings

The causes of and corrections for the warnings are given in the following table. Contact your Yaskawa representative if you cannot solve a problem with the correction given in the table.

Warning Number: Warning Name	Possible Cause	Confirmation	Correction	Reference
A.900: Position Deviation Overflow	The Servomotor U, V, and W wiring is not correct.	Check the wiring of the Servomotor's Main Circuit Cables.	Make sure that there are no faulty connections in the wiring for the Servomotor and encoder.	–
	A SERVOPACK gain is too low.	Check the SERVO-PACK gains.	Increase the servo gain, e.g., by using autotuning without a host reference.	*
	The frequency of the position reference pulse is too high.	Reduce the reference pulse frequency and try operating the SERVO-PACK.	Reduce the position reference pulse frequency or the reference acceleration rate, or reconsider the electronic gear ratio.	*
	The acceleration of the position reference is too high.	Reduce the reference acceleration and try operating the SERVO-PACK.	Apply smoothing, i.e., by using Pn216 (Position Reference Acceleration/ Deceleration Time Constant).	*
	The excessive position deviation alarm level (Pn520 × Pn51E/100) is too low for the operating conditions.	Check excessive position deviation alarm level (Pn520 × Pn51E/100) to see if it is set to an appropriate value.	Optimize the settings of Pn520 and Pn51E.	*
	A failure occurred in the SERVO-PACK.	–	Turn the power supply to the SERVOPACK OFF and ON again. If an alarm still occurs, the SERVOPACK may be faulty. Replace the SERVOPACK.	–
A.901: Position Deviation Overflow Alarm at Servo ON	The position deviation exceeded the parameter settings (Pn526 × Pn528/100) when the servo was turned ON.	–	Set the position deviation to be cleared while the servo is OFF. Optimize the setting of Pn528 (Position Deviation Overflow Warning Level at Servo ON).	*

Continued on next page.

4.1 SERVOPACKs with Analog Voltage/Pulse Train References

4.1.6 Troubleshooting Warnings

Continued from previous page.

Warning Number: Warning Name	Possible Cause	Confirmation	Correction	Reference
A.910: Overload (warning before an A.710 or A.720 alarm occurs)	The wiring is not correct or there is a faulty contact in the motor or encoder wiring.	Check the wiring.	Make sure that the Servomotor and encoder are correctly wired.	–
	Operation was performed that exceeded the overload protection characteristics.	Check the motor overload characteristics and Run command.	Reconsider the load and operating conditions. Or, increase the motor capacity.	–
	An excessive load was applied during operation because the Servomotor was not driven because of mechanical problems.	Check the operation reference and motor speed.	Remove the mechanical problem.	–
	The overload warning level (Pn52B) is not suitable.	Check that the overload warning level (Pn52B) is suitable.	Set a suitable overload warning level (Pn52B).	*
	A failure occurred in the SERVOPACK.	–	The SERVOPACK may be faulty. Replace the SERVOPACK.	–
A.911: Vibration	Abnormal vibration was detected during motor operation.	Check for abnormal motor noise, and check the speed and torque waveforms during operation.	Reduce the motor speed. Or, reduce the servo gain with custom tuning.	*
	The setting of Pn103 (Moment of Inertia Ratio) is greater than the actual moment of inertia or was greatly changed.	Check the moment of inertia ratio or mass ratio.	Set Pn103 (Moment of Inertia Ratio) to an appropriate value.	*
	The vibration detection level (Pn312 or Pn384) is not suitable.	Check that the vibration detection level (Pn312 or Pn384) is suitable.	Set a suitable vibration detection level (Pn312 or Pn384).	*

Continued on next page.

Continued from previous page.

Warning Number: Warning Name	Possible Cause	Confirmation	Correction	Reference
A.912: Internal Temperature Warning 1 (Control Board Temperature Error)	The surrounding temperature is too high.	Check the surrounding temperature using a thermostat. Or, check the operating status with the SERVOPACK installation environment monitor.	Decrease the surrounding temperature by improving the SERVOPACK installation conditions.	*
	An overload alarm was reset by turning OFF the power supply too many times.	Check the alarm display to see if there is an overload alarm.	Change the method for resetting the alarm.	–
	There was an excessive load or operation was performed that exceeded the regenerative processing capacity.	Use the accumulated load ratio to check the load during operation, and use the regenerative load ratio to check the regenerative processing capacity.	Reconsider the load and operating conditions.	–
	The SERVOPACK installation orientation is not correct or there is insufficient space around the SERVOPACK.	Check the SERVOPACK installation conditions.	Install the SERVOPACK according to specifications.	*
	A failure occurred in the SERVOPACK.	–	The SERVOPACK may be faulty. Replace the SERVOPACK.	–
A.913: Internal Temperature Warning 2 (Power Board Temperature Error)	The surrounding temperature is too high.	Check the surrounding temperature using a thermostat. Or, check the operating status with the SERVOPACK installation environment monitor.	Decrease the surrounding temperature by improving the SERVOPACK installation conditions.	*
	An overload alarm was reset by turning OFF the power supply too many times.	Check the alarm display to see if there is an overload alarm.	Change the method for resetting the alarm.	–
	There was an excessive load or operation was performed that exceeded the regenerative processing capacity.	Use the accumulated load ratio to check the load during operation, and use the regenerative load ratio to check the regenerative processing capacity.	Reconsider the load and operating conditions.	–
	The SERVOPACK installation orientation is not correct or there is insufficient space around the SERVOPACK.	Check the SERVOPACK installation conditions.	Install the SERVOPACK according to specifications.	*
	A failure occurred in the SERVOPACK.	–	The SERVOPACK may be faulty. Replace the SERVOPACK.	–

Continued on next page.

4.1 SERVOPACKs with Analog Voltage/Pulse Train References

4.1.6 Troubleshooting Warnings

Continued from previous page.

Warning Number: Warning Name	Possible Cause	Confirmation	Correction	Reference
A.920: Regenerative Overload (warning before an A.320 alarm occurs)	The power supply voltage exceeded the specified range.	Measure the power supply voltage.	Set the power supply voltage within the specified range.	-
	There is insufficient external regenerative resistance, regenerative resistor capacity, or SERVOPACK capacity, or there has been a continuous regeneration state.	Check the operating conditions or the capacity using the SigmaJunmaSize+ Capacity Selection Software or another means.	Change the regenerative resistance value, regenerative resistance capacity, or SERVOPACK capacity. Reconsider the operating conditions using the SigmaJunmaSize+ Capacity Selection Software or other means.	-
	There was a continuous regeneration state because a negative load was continuously applied.	Check the load applied to the Servomotor during operation.	Reconsider the system including the servo, machine, and operating conditions.	-
A.921: Dynamic Brake Overload (warning before an A.731 alarm occurs)	The Servomotor was rotated by an external force.	Check the operation status.	Implement measures to ensure that the motor will not be rotated by an external force.	-
	When the Servomotor was stopped with the dynamic brake, the rotational or linear kinetic energy exceeded the capacity of the dynamic brake resistor.	Check the power consumed by the DB resistor to see how frequently the DB is being used.	Reconsider the following: <ul style="list-style-type: none"> • Reduce the Servomotor command speed. • Decrease the moment of inertia or mass. • Reduce the frequency of stopping with the dynamic brake. 	-
	A failure occurred in the SERVOPACK.	-	The SERVOPACK may be faulty. Replace the SERVOPACK.	-
A.923: SERVOPACK Built-in Fan Stopped	The fan inside the SERVOPACK stopped.	Check for foreign matter inside the SERVOPACK.	Remove foreign matter from the SERVOPACK. If an alarm still occurs, the SERVOPACK may be faulty. Replace the SERVOPACK.	-
A.930: Absolute Encoder Battery Error (The absolute encoder battery voltage was lower than the specified level.) (Detected only when an absolute encoder is connected.)	The battery connection is faulty or a battery is not connected.	Check the battery connection.	Correct the battery connection.	*
	The battery voltage is lower than the specified value (2.7 V).	Measure the battery voltage.	Replace the battery.	*
	A failure occurred in the SERVOPACK.	-	The SERVOPACK may be faulty. Replace the SERVOPACK.	-
A.941: Change of Parameters Requires Restart	Parameters have been changed that require the power supply to be turned OFF and ON again.	-	Turn the power supply to the SERVOPACK OFF and ON again.	-

Continued on next page.

Continued from previous page.

Warning Number: Warning Name	Possible Cause	Confirmation	Correction	Reference
A.942: Speed Ripple Compensation Information Disagreement	The speed ripple compensation information stored in the encoder does not agree with the speed ripple compensation information stored in the SERVOPACK.	–	Reset the speed ripple compensation value on the SigmaWin+.	*
		–	Set Pn423 to n.□□1□ (Do not detect A.942 alarms). However, changing the setting may increase the speed ripple.	*
		–	Set Pn423 to n.□□□0 (Disable speed ripple compensation). However, changing the setting may increase the speed ripple.	*
A.971: Undervoltage	For a 200-V SERVOPACK, the AC power supply voltage dropped below 140 V.	Measure the power supply voltage.	Set the power supply voltage within the specified range.	–
	The power supply voltage dropped during operation.	Measure the power supply voltage.	Increase the power supply capacity.	–
	A momentary power interruption occurred.	Measure the power supply voltage.	If you have changed the setting of Pn509 (Momentary Power Interruption Hold Time), decrease the setting.	*
	The SERVOPACK fuse is blown out.	–	Replace the SERVOPACK and connect a reactor.	*
	A failure occurred in the SERVOPACK.	–	The SERVOPACK may be faulty. Replace the SERVOPACK.	–
A.9A0: Overtravel (Overtravel status was detected.)	Overtravel was detected while the servo was ON.	Check the status of the overtravel signals on the input signal monitor.	Even if an overtravel signal is not shown by the input signal monitor, momentary overtravel may have been detected. Take the following precautions. <ul style="list-style-type: none"> • Do not specify movements that would cause overtravel from the host controller. • Check the wiring of the overtravel signals. • Implement countermeasures against noise. 	*
A.9b0: Preventative Maintenance Warning	One of the consumable parts has reached the end of its service life.	–	Replace the part. Contact your Yaskawa representative for replacement.	*

* Refer to the following manual for details.

 Σ-7-Series Σ-7S SERVOPACK with Analog Voltage/Pulse Train References Product Manual
(Manual No.: SIEP S800001 26)

4.1.7 Troubleshooting Based on the Operation and Conditions of the Servomotor

This section provides troubleshooting based on the operation and conditions of the Servomotor, including causes and corrections.

Turn OFF the Servo System before troubleshooting the items shown in bold lines in the table.

Problem	Possible Cause	Confirmation	Correction	Reference
Servomotor Does Not Start	The control power supply is not turned ON.	Measure the voltage between control power supply terminals.	Correct the wiring so that the control power supply is turned ON.	-
	The main circuit power supply is not turned ON.	Measure the voltage between the main circuit power input terminals.	Correct the wiring so that the main circuit power supply is turned ON.	-
	The I/O signal connector (CN1) pins are not wired correctly or are disconnected.	Check the wiring condition of the I/O signal connector (CN1) pins.	Correct the wiring of the I/O signal connector (CN1) pins.	*
	The wiring for the Servomotor Main Circuit Cables or Encoder Cable is disconnected.	Check the wiring conditions.	Wire the cable correctly.	-
	There is an overload on the Servomotor.	Operate the Servomotor with no load and check the load status.	Reduce the load or replace the Servomotor with a larger capacity.	-
	The type of encoder that is being used does not agree with the setting of Pn002 = n.□X□□ (Encoder Usage).	Check the type of the encoder that is being used and the setting of Pn002 = n.□X□□.	Set Pn002 = n.□X□□ according to the type of the encoder that is being used.	*
	No speed or position reference is input.	Check the allocation status of the input signals.	Allocate an input signal so that the speed and position references are input correctly.	*
	There is a mistake in the input signal allocations (Pn50A to Pn50D, Pn515, and Pn516).	Check the input signal allocations (Pn50A to Pn50D, Pn515, and Pn516).	Correctly allocate the input signals (Pn50A to Pn50D, Pn515, and Pn516).	*
	The /S-ON (Servo ON) signal is OFF.	Check the settings of Pn50A = n.□□□X (Input Signal Allocation Mode) and Pn50A =n.□□X□ (/S-ON (Servo ON) Signal Allocation).	Set Pn50A = n.□□□X correctly and turn ON the /S-ON signal.	*
	The function setting of the /P-CON (Proportional Control) signal is not correct.	Check the setting of Pn000 = n.□□X□ (Control Method Selection).	Set the parameter to match the application.	*
	The SEN input is OFF.	Check the ON/OFF status of the SEN input.	If you are using an absolute encoder, turn ON the SEN signal.	*
	The reference pulse mode selection is not correct.	Check the setting of Pn200 =n.□□□X (Reference Pulse Form) and the reference pulse form.	Set Pn200 =n.□□□X so that it agrees with the reference pulse form.	*
	Speed control: The speed reference input is not appropriate.	Check between the speed reference input (V-REF) and signal ground (SG) to see if the control method and the input agree.	Correctly set the control method and input method.	*

Continued on next page.

Continued from previous page.

Problem	Possible Cause	Confirmation	Correction	Reference
Servomotor Does Not Start	Torque control: The torque reference input is not appropriate.	Check between the torque reference input (T-REF) and signal ground (SG) to see if the control method and the input agree.	Correctly set the control method and input method.	*
	Position control: The reference pulse input is not appropriate.	Check the setting of Pn200 = n.□□□X (Reference Pulse Form) and the sign and pulse signals.	Correctly set the control method and input method.	*
	The /CLR (Position Deviation Clear) input signal has not been turned OFF.	Check the /CLR signal (CN1-14 and CN1-15).	Turn OFF the /CLR signal.	*
	The P-OT (Forward Drive Prohibit) or N-OT (Reverse Drive Prohibit) signal is still OFF.	Check the P-OT and N-OT signals.	Turn ON the P-OT and N-OT signals.	*
	The safety input signals (/HWBB1 or /HWBB2) were not turned ON.	Check the /HWBB1 and /HWBB2 input signals.	Turn ON the /HWBB1 and /HWBB2 input signals. If you are not using the safety function, connect the Safety Jumper Connector (provided as an accessory) to CN8.	*
	The FSTP (Forced Stop Input) signal is still OFF.	Check the FSTP signal.	<ul style="list-style-type: none"> Turn ON the FSTP signal. If you will not use the function to force the motor to stop, set Pn516 = n.□□□X (FSTP (Forced Stop Input) Signal Allocation) to disable the signal. 	*
	A failure occurred in the SERVOPACK.	—	Replace the SERVOPACK.	—
	The polarity detection was not executed.	Check the setting of Pn080 = n.□□□X (Polarity Sensor Selection).	Correct the parameter setting.	*
Check the /S-ON (Servo ON) or /P-DET (Polarity Detection) input signal.		<ul style="list-style-type: none"> If you are using an incremental linear encoder, turn ON the /S-ON or /P-DET signal. If you are using an absolute linear encoder, turn OFF the external /S-ON signal and execute polarity detection. 	*	

Continued on next page.

4.1 SERVOPACKs with Analog Voltage/Pulse Train References

4.1.7 Troubleshooting Based on the Operation and Conditions of the Servomotor

Continued from previous page.

Problem	Possible Cause	Confirmation	Correction	Reference
Servomotor Moves Instantaneously, and Then Stops	There is a mistake in the Servomotor wiring.	Check the wiring.	Wire the Servomotor correctly.	-
	There is a mistake in the wiring of the encoder or Serial Converter Unit.	Check the wiring.	Wire the Serial Converter Unit correctly.	-
	There is a mistake in the linear encoder wiring.	Check the wiring.	Wire the cable correctly.	-
	The setting of Pn282 (Linear Encoder Scale Pitch) is not correct.	Check the setting of Pn282.	Correct the setting of Pn282.	*
	The count-up direction of the linear encoder does not match the forward direction of the Moving Coil in the motor.	Check the directions.	Change the setting of Pn080 = n.□□X□ (Motor Phase Sequence Selection). Place the linear encoder and motor in the same direction.	*
	Polarity detection was not performed correctly.	Check to see if electrical angle 2 (electrical angle from polarity origin) at any position is between $\pm 10^\circ$.	Correct the settings for the polarity detection-related parameters.	-
Servomotor Speed Is Unstable	There is a faulty connection in the Servomotor wiring.	The connector connections for the power line (U, V, and W phases) and the encoder or Serial Converter Unit may be unstable. Check the wiring.	Tighten any loose terminals or connectors and correct the wiring.	-
Servomotor Moves without a Reference Input	Speed control: The speed reference input is not appropriate.	Check between the speed reference input (V-REF) and signal ground (SG) to see if the control method and the input agree.	Correctly set the control method and input method.	*
	Torque control: The torque reference input is not appropriate.	Check between the torque reference input (T-REF) and signal ground (SG) to see if the control method and the input agree.	Correctly set the control method and input method.	*
	The speed reference offset is not correct.	The SERVOPACK offset is adjusted incorrectly.	Adjust the SERVOPACK offset.	*
	Position control: The reference pulse input is not appropriate.	Check the setting of Pn200 = n.□□□X (Reference Pulse Form) and the sign and pulse signals.	Correctly set the control method and input method.	-
	A failure occurred in the SERVOPACK.	-	Replace the SERVOPACK.	-
	The count-up direction of the linear encoder does not match the forward direction of the Moving Coil in the motor.	Check the directions.	Change the setting of Pn080 = n.□□X□ (Motor Phase Sequence Selection). Match the linear encoder direction and Servomotor direction.	*
	Polarity detection was not performed correctly.	Check to see if electrical angle 2 (electrical angle from polarity origin) at any position is between $\pm 10^\circ$.	Correct the settings for the polarity detection-related parameters.	-

Continued on next page.

4.1.7 Troubleshooting Based on the Operation and Conditions of the Servomotor

Continued from previous page.

Problem	Possible Cause	Confirmation	Correction	Reference
Dynamic Brake Does Not Operate	The setting of Pn001 = n.□□□X (Motor Stopping Method for Servo OFF and Group 1 Alarms) is not suitable.	Check the setting of Pn001 = n.□□□X.	Set Pn001 = n.□□□X correctly.	-
	The dynamic brake resistor is disconnected.	Check the moment of inertia, motor speed, and dynamic brake frequency of use. If the moment of inertia, motor speed, or dynamic brake frequency of use is excessive, the dynamic brake resistance may be disconnected.	Replace the SERVO-PACK. To prevent disconnection, reduce the load.	-
	There was a failure in the dynamic brake drive circuit.	-	There is a defective component in the dynamic brake circuit. Replace the SERVO-PACK.	-

Continued on next page.

4.1 SERVOPACKs with Analog Voltage/Pulse Train References

4.1.7 Troubleshooting Based on the Operation and Conditions of the Servomotor

Continued from previous page.

Problem	Possible Cause	Confirmation	Correction	Reference
Abnormal Noise from Servomotor	The Servomotor vibrated considerably while performing the tuning-less function with the default settings.	Check the waveform of the motor speed.	Reduce the load so that the moment of inertia ratio or mass ratio is within the allowable value, or increase the load level or reduce the rigidity level in the tuning-less level settings.	*
	The machine mounting is not secure.	Check to see if there are any loose mounting screws.	Tighten the mounting screws.	-
	The machine mounting is not secure.	Check to see if there is misalignment in the coupling.	Align the coupling.	-
		Check to see if the coupling is balanced.	Balance the coupling.	-
	The bearings are defective.	Check for noise and vibration around the bearings.	Replace the Servomotor.	-
	There is a vibration source at the driven machine.	Check for any foreign matter, damage, or deformation in the machine's moving parts.	Consult with the machine manufacturer.	-
	Noise interference occurred because of incorrect I/O signal cable specifications.	Check the I/O signal cables to see if they satisfy specifications. Use shielded twisted-pair wire cables or screened twisted-pair cables with conductors of at least 0.12 mm ² .	Use cables that satisfy the specifications.	-
	Noise interference occurred because an I/O signal cable is too long.	Check the lengths of the I/O signal cables.	The I/O signal cables must be no longer than 3 m.	-
	Noise interference occurred because of incorrect Encoder Cable specifications.	Make sure that the rotary or Linear Encoder Cable satisfies the specifications. Use a shielded twisted-pair wire cable or a screened twisted-pair cable with a conductors of at least 0.12 mm ² .	Use cables that satisfy the specifications.	-
	Noise interference occurred because the Encoder Cable is too long.	Check the length of the Encoder Cable.	<ul style="list-style-type: none"> Rotary Servomotors: The Encoder Cable length must be 50 m max. Linear Servomotors: Make sure that the Serial Converter Unit cable is no longer than 20 m and that the Linear Encoder Cable and the Sensor Cable are no longer than 15 m each. 	-
Noise interference occurred because the Encoder Cable is damaged.	Check the Encoder Cable to see if it is pinched or the sheath is damaged.	Replace the Encoder Cable and correct the cable installation environment.	-	

Continued on next page.

Continued from previous page.

Problem	Possible Cause	Confirmation	Correction	Reference
Abnormal Noise from Servomotor	The Encoder Cable was subjected to excessive noise interference.	Check to see if the Encoder Cable is bundled with a high-current line or installed near a high-current line.	Correct the cable layout so that no surge is applied by high-current lines.	-
	There is variation in the FG potential because of the influence of machines on the Servomotor side, such as a welder.	Check to see if the machines are correctly grounded.	Properly ground the machines to separate them from the FG of the encoder.	-
	There is a SERVOPACK pulse counting error due to noise.	Check to see if there is noise interference on the signal line from the encoder.	Implement countermeasures against noise for the encoder wiring.	-
	The encoder was subjected to excessive vibration or shock.	Check to see if vibration from the machine occurred. Check the Servomotor installation (mounting surface precision, securing state, and alignment). Check the linear encoder installation (mounting surface precision and securing method).	Reduce machine vibration. Improve the mounting state of the Servomotor or linear encoder.	-
	A failure occurred in the encoder.	-	Replace the Servomotor.	-
	A failure occurred in the Serial Converter Unit.	-	Replace the Serial Converter Unit.	-
	A failure occurred in the linear encoder.	-	Replace the linear encoder.	-
Servomotor Vibrates at Frequency of Approx. 200 Hz to 400 Hz.	The servo gains are not balanced.	Check to see if the servo gains have been correctly tuned.	Perform autotuning without a host reference.	*
	The setting of Pn100 (Speed Loop Gain) is too high.	Check the setting of Pn100. The default setting is Kv = 40.0 Hz.	Set Pn100 to an appropriate value.	-
	The setting of Pn102 (Position Loop Gain) is too high.	Check the setting of Pn102. The default setting is Kp = 40.0/s.	Set Pn102 to an appropriate value.	-
	The setting of Pn101 (Speed Loop Integral Time Constant) is not appropriate.	Check the setting of Pn101. The default setting is Ti = 20.0 ms.	Set Pn101 to an appropriate value.	-
	The setting of Pn103 (Moment of Inertia Ratio or Mass Ratio) is not appropriate.	Check the setting of Pn103.	Set Pn103 to an appropriate value.	-

Continued on next page.

4.1 SERVOPACKs with Analog Voltage/Pulse Train References

4.1.7 Troubleshooting Based on the Operation and Conditions of the Servomotor

Continued from previous page.

Problem	Possible Cause	Confirmation	Correction	Reference
Large Motor Speed Overshoot on Starting and Stopping	The servo gains are not balanced.	Check to see if the servo gains have been correctly tuned.	Perform autotuning without a host reference.	*
	The setting of Pn100 (Speed Loop Gain) is too high.	Check the setting of Pn100. The default setting is Kv = 40.0 Hz.	Set Pn100 to an appropriate value.	-
	The setting of Pn102 (Position Loop Gain) is too high.	Check the setting of Pn102. The default setting is Kp = 40.0/s.	Set Pn102 to an appropriate value.	-
	The setting of Pn101 (Speed Loop Integral Time Constant) is not appropriate.	Check the setting of Pn101. The default setting is Ti = 20.0 ms.	Set Pn101 to an appropriate value.	-
	The setting of Pn103 (Moment of Inertia Ratio or Mass Ratio) is not appropriate.	Check the setting of Pn103.	Set Pn103 to an appropriate value.	-
	The torque reference is saturated.	Check the waveform of the torque reference.	Use the mode switch.	-
	The force limits (Pn483 and Pn484) are set to the default values.	The default values of the force limits and Pn483 = 30% and Pn484 = 30%.	Set Pn483 and Pn484 to appropriate values.	*
Absolute Encoder Position Deviation Error (The position that was saved in the host controller when the power was turned OFF is different from the position when the power was next turned ON.)	Noise interference occurred because of incorrect Encoder Cable specifications.	Check the Encoder Cable to see if it satisfies specifications. Use a shielded twisted-pair wire cable or a screened twisted-pair cable with conductors of at least 0.12 mm ² .	Use cables that satisfy the specifications.	-
	Noise interference occurred because the Encoder Cable is too long.	Check the length of the Encoder Cable.	<ul style="list-style-type: none"> Rotary Servomotors: The Encoder Cable length must be 50 m max. Linear Servomotors: Make sure that the Serial Converter Unit cable is no longer than 20 m and that the Linear Encoder Cable and the Sensor Cable are no longer than 15 m each. 	-
	Noise interference occurred because the Encoder Cable is damaged.	Check the Encoder Cable to see if it is pinched or the sheath is damaged.	Replace the Encoder Cable and correct the cable installation environment.	-
	Replace the Encoder Cable and correct the cable installation environment.	Check to see if the Encoder Cable is bundled with a high-current line or installed near a high-current line.	Correct the cable layout so that no surge is applied by high-current lines.	-
	There is variation in the FG potential because of the influence of machines on the Servomotor side, such as a welder.	Check to see if the machines are correctly grounded.	Properly ground the machines to separate them from the FG of the encoder.	-

Continued on next page.

Continued from previous page.

Problem	Possible Cause	Confirmation	Correction	Reference
Absolute Encoder Position Deviation Error (The position that was saved in the host controller when the power was turned OFF is different from the position when the power was next turned ON.)	There is a SERVOPACK pulse counting error due to noise.	Check to see if there is noise interference on the I/O signal line from the encoder or Serial Converter Unit.	Implement countermeasures against noise for the encoder or Serial Converter Unit wiring.	-
	The encoder was subjected to excessive vibration or shock.	Check to see if vibration from the machine occurred. Check the Servomotor installation (mounting surface precision, securing state, and alignment). Check the linear encoder installation (mounting surface precision and securing method).	Reduce machine vibration. Improve the mounting state of the Servomotor or linear encoder.	-
	A failure occurred in the encoder.	-	Replace the Servomotor or linear encoder.	-
	A failure occurred in the SERVOPACK.	-	Replace the SERVOPACK.	-
	Host Controller Multiturn Data or Absolute Encoder Position Data Reading Error	Check the error detection section of the host controller.	Correct the error detection section of the host controller.	-
		Check to see if the host controller is executing data parity checks.	Perform parity checks for the multiturn data or absolute encoder position data.	-
		Check for noise interference in the cable between the SERVOPACK and the host controller.	Implement countermeasures against noise and then perform parity checks again for the multiturn data or absolute encoder position data.	-

Continued on next page.

4.1 SERVOPACKs with Analog Voltage/Pulse Train References

4.1.7 Troubleshooting Based on the Operation and Conditions of the Servomotor

Continued from previous page.

Problem	Possible Cause	Confirmation	Correction	Reference
Overtravel Occurred	The P-OT/N-OT (Forward Drive Prohibit or Reverse Drive Prohibit) signal was input.	Check the external power supply (+24 V) voltage for the input signals.	Correct the external power supply (+24 V) voltage for the input signals.	-
		Check the operating condition of the overtravel limit switches.	Make sure that the overtravel limit switches operate correctly.	-
		Check the wiring of the overtravel limit switches.	Correct the wiring of the overtravel limit switches.	*
		Check the settings of the overtravel input signal allocations (Pn50A/Pn50B).	Set the parameters to correct values.	*
	The P-OT/N-OT (Forward Drive Prohibit or Reverse Drive Prohibit) signal malfunctioned.	Check for fluctuation in the external power supply (+24 V) voltage for the input signals.	Eliminate fluctuation from the external power supply (+24 V) voltage for the input signals.	-
		Check to see if the operation of the overtravel limit switches is unstable.	Stabilize the operating condition of the overtravel limit switches.	-
		Check the wiring of the overtravel limit switches (e.g., check for cable damage and loose screws).	Correct the wiring of the overtravel limit switches.	-
	There is a mistake in the allocation of the P-OT or N-OT (Forward Drive Prohibit or Reverse Drive Prohibit) signal in Pn50A = n.X□□□ or Pn50B = n.□□□X.	Check to see if the P-OT signal is allocated in Pn50A = n.X□□□.	If another signal is allocated in Pn50A = n.X□□□, allocate the P-OT signal instead.	*
		Check to see if the N-OT signal is allocated in Pn50B = n.□□□X.	If another signal is allocated in Pn50B = n.□□□X, allocate the N-OT signal instead.	*
	Overtravel Occurred	The selection of the Servomotor stopping method is not correct.	Check the servo OFF stopping method set in Pn001 = n.□□□X or Pn001 = n.□□X□.	Select a Servomotor stopping method other than coasting to a stop.
Check the torque control stopping method set in Pn001 = n.□□□X or Pn001 = n.□□X□.			Select a Servomotor stopping method other than coasting to a stop.	*
Improper Stop Position for Overtravel (OT) Signal	The limit switch position and dog length are not appropriate.	-	Install the limit switch at the appropriate position.	-
	The overtravel limit switch position is too close for the coasting distance.	-	Install the overtravel limit switch at the appropriate position.	-

Continued on next page.

Continued from previous page.

Problem	Possible Cause	Confirmation	Correction	Reference
Position Deviation (without Alarm)	Noise interference occurred because of incorrect Encoder Cable specifications.	Check the Encoder Cable to see if it satisfies specifications. Use a shielded twisted-pair wire cable or a screened twisted-pair cable with conductors of at least 0.12 mm ² .	Use cables that satisfy the specifications.	-
	Noise interference occurred because the Encoder Cable is too long.	Check the length of the Encoder Cable.	<ul style="list-style-type: none"> Rotary Servomotors: The Encoder Cable length must be 50 m max. Linear Servomotors: Make sure that the Serial Converter Unit cable is no longer than 20 m and that the Linear Encoder Cable and the Sensor Cable are no longer than 15 m each. 	-
	Noise interference occurred because the Encoder Cable is damaged.	Check the Encoder Cable to see if it is pinched or the sheath is damaged.	Replace the Encoder Cable and correct the cable installation environment.	-
	The Encoder Cable was subjected to excessive noise interference.	Check to see if the Encoder Cable is bundled with a high-current line or installed near a high-current line.	Correct the cable layout so that no surge is applied by high-current lines.	-
	There is variation in the FG potential because of the influence of machines on the Servomotor side, such as a welder.	Check to see if the machines are correctly grounded.	Properly ground the machines to separate them from the FG of the encoder.	-
	There is a SERVOPACK pulse counting error due to noise.	Check to see if there is noise interference on the I/O signal line from the encoder or Serial Converter Unit.	Implement countermeasures against noise for the encoder wiring or Serial Converter Unit wiring.	-

Continued on next page.

4.1 SERVOPACKs with Analog Voltage/Pulse Train References

4.1.7 Troubleshooting Based on the Operation and Conditions of the Servomotor

Continued from previous page.

Problem	Possible Cause	Confirmation	Correction	Reference
Position Deviation (without Alarm)	The encoder was subjected to excessive vibration or shock.	Check to see if vibration from the machine occurred. Check the Servomotor installation (mounting surface precision, securing state, and alignment). Check the linear encoder installation (mounting surface precision and securing method).	Reduce machine vibration. Improve the mounting state of the Servomotor or linear encoder.	-
	The coupling between the machine and Servomotor is not suitable.	Check to see if position offset occurs at the coupling between machine and Servomotor.	Correctly secure the coupling between the machine and Servomotor.	-
	Noise interference occurred because of incorrect I/O signal cable specifications.	Check the I/O signal cables to see if they satisfy specifications. Use a shielded twisted-pair wire cable or a screened twisted-pair cable with conductors of at least 0.12 mm ² .	Use cables that satisfy the specifications.	-
	If reference pulse input multiplication switching is being used, noise may be causing the I/O signals used for this function (/PSEL and /PSELA) to be falsely detected.	Check the I/O signal cables to see if they satisfy specifications. Use a shielded twisted-pair wire cable or a screened twisted-pair cable with conductors of at least 0.12 mm ² .	Use cables that satisfy the specifications.	-
	Noise interference occurred because an I/O signal cable is too long.	Check the lengths of the I/O signal cables.	The I/O signal cables must be no longer than 3 m.	-
	An encoder fault occurred. (The pulse count does not change.)	-	Replace the Servomotor or linear encoder.	-
	A failure occurred in the SERVOPACK.	-	Replace the SERVOPACK.	-
Servomotor Overheated	The surrounding air temperature is too high.	Measure the surrounding air temperature around the Servomotor.	Reduce the surrounding air temperature to 40°C or less.	-
	The surface of the Servomotor is dirty.	Visually check the surface for dirt.	Clean dirt, dust, and oil from the surface.	-
	There is an overload on the Servomotor.	Check the load status with a monitor.	If the Servomotor is overloaded, reduce the load or replace the Servo Drive with a SERVOPACK and Servomotor with larger capacities.	-
	Polarity detection was not performed correctly.	Check to see if electrical angle 2 (electrical angle from polarity origin) at any position is between ±10°.	Correct the settings for the polarity detection-related parameters.	-

* Refer to the following manual for details.

 Σ-7-Series Σ-7S SERVOPACK with Analog Voltage/Pulse Train References Product Manual (Manual No.: SIEP S800001 26)

4.2

SERVOPACKs with MECHATROLINK-III Communications References

4.2.1 Alarm Displays

If an error occurs in the SERVOPACK, an alarm number will be displayed on the panel display.

If there is an alarm, the display will change in the following order.

Example: Alarm A.E60

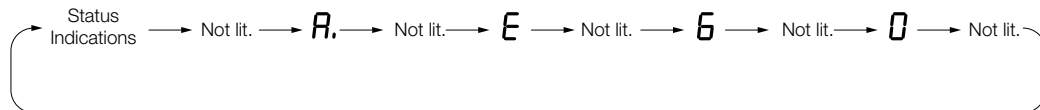

4.2.2 List of Alarms

The list of alarms gives the alarm name, alarm meaning, alarm stopping method, and alarm reset possibility in order of the alarm numbers.

Servomotor Stopping Method for Alarms

Refer to the following manual for information on the stopping method for alarms.

📖 Σ -7-Series Σ -7S SERVOPACK with MECHATROLINK-III Communications References Product Manual (Manual No.: SIEP S800001 28)

Alarm Reset Possibility

Yes: You can use an alarm reset to clear the alarm. However, this assumes that the cause of the alarm has been removed.

No: You cannot clear the alarm.

List of Alarms

Alarm Number	Alarm Name	Alarm Meaning	Servo-motor Stopping Method	Alarm Reset Possible?
A.020	Parameter Checksum Error	There is an error in the parameter data in the SERVOPACK.	Gr.1	No
A.021	Parameter Format Error	There is an error in the parameter data format in the SERVOPACK.	Gr.1	No
A.022	System Checksum Error	There is an error in the parameter data in the SERVOPACK.	Gr.1	No
A.024	System Alarm	An internal program error occurred in the SERVOPACK.	Gr.1	No
A.025	System Alarm	An internal program error occurred in the SERVOPACK.	Gr.1	No
A.030	Main Circuit Detector Error	There is an error in the detection data for the main circuit.	Gr.1	Yes
A.040	Parameter Setting Error	A parameter setting is outside of the setting range.	Gr.1	No

Continued on next page.

Continued from previous page.

Alarm Number	Alarm Name	Alarm Meaning	Servo-motor Stopping Method	Alarm Reset Possible?
A.041	Encoder Output Pulse Setting Error	The setting of Pn212 (Number of Encoder Output Pulses) or Pn281 (Encoder Output Resolution) is outside of the setting range or does not satisfy the setting conditions.	Gr. 1	No
A.042	Parameter Combination Error	The combination of some parameters exceeds the setting range.	Gr. 1	No
A.044	Semi-Closed/Fully-Closed Loop Control Parameter Setting Error	The settings of the Option Module and Pn002 = n.X□□□ (External Encoder Usage) do not match.	Gr. 1	No
A.04A	Parameter Setting Error 2	There is an error in the bank members or bank data settings.	Gr. 1	No
A.050	Combination Error	The capacities of the SERVOPACK and Servomotor do not match.	Gr. 1	Yes
A.051	Unsupported Device Alarm	An unsupported device was connected.	Gr. 1	No
A.070	Motor Type Change Detected	The connected motor is a different type of motor from the previously connected motor.	Gr. 1	No
A.080	Linear Encoder Pitch Setting Error	The setting of Pn282 (Linear Encoder Scale Pitch) has not been changed from the default setting.	Gr. 1	No
A.0b0	Invalid Servo ON Command Alarm	The SV_ON (Servo ON) command was sent from the host controller after a utility function that turns ON the Servomotor was executed.	Gr. 1	Yes
A.100	Overcurrent Detected	An overcurrent flowed through the power transformer or the heat sink overheated.	Gr. 1	No
A.101	Motor Overcurrent Detected	The current to the motor exceeded the allowable current.	Gr. 1	No
A.300	Regeneration Error	There is an error related to regeneration.	Gr. 1	Yes
A.320	Regenerative Overload	A regenerative overload occurred.	Gr.2	Yes
A.330	Main Circuit Power Supply Wiring Error	<ul style="list-style-type: none"> The AC power supply input setting or DC power supply input setting is not correct. The power supply wiring is not correct. 	Gr. 1	Yes
A.400	Overvoltage	The main circuit DC voltage is too high.	Gr. 1	Yes
A.410	Undervoltage	The main circuit DC voltage is too low.	Gr.2	Yes
A.510	Overspeed	The motor exceeded the maximum speed.	Gr. 1	Yes
A.511	Encoder Output Pulse Overspeed	<ul style="list-style-type: none"> Rotary Servomotor: The pulse output speed for the setting of Pn212 (Number of Encoder Output Pulses) was exceeded. Linear Servomotor: The motor speed upper limit for the setting of Pn281 (Encoder Output Resolution) was exceeded. 	Gr. 1	Yes
A.520	Vibration Alarm	Abnormal oscillation was detected in the motor speed.	Gr. 1	Yes
A.521	Autotuning Alarm	Vibration was detected during autotuning for the tuning-less function.	Gr. 1	Yes
A.550	Maximum Speed Setting Error	The setting of Pn385 (Maximum Motor Speed) is greater than the maximum motor speed.	Gr. 1	Yes
A.710	Instantaneous Overload	The Servomotor was operating for several seconds to several tens of seconds under a torque that largely exceeded the rating.	Gr.2	Yes
A.720	Continuous Overload	The Servomotor was operating continuously under a torque that exceeded the rating.	Gr. 1	Yes
A.730	Dynamic Brake Overload	When the dynamic brake was applied, the rotational or linear kinetic energy exceeded the capacity of the dynamic brake resistor.	Gr. 1	Yes
A.731				

Continued on next page.

Continued from previous page.

Alarm Number	Alarm Name	Alarm Meaning	Servo-motor Stopping Method	Alarm Reset Possible?
A.740	Inrush Current Limiting Resistor Overload	The main circuit power supply was frequently turned ON and OFF.	Gr.1	Yes
A.7A1	Internal Temperature Error 1 (Control Board Temperature Error)	The surrounding temperature of the control PCB is abnormal.	Gr.2	Yes
A.7A2	Internal Temperature Error 2 (Power Board Temperature Error)	The surrounding temperature of the power PCB is abnormal.	Gr.2	Yes
A.7A3	Internal Temperature Sensor Error	An error occurred in the temperature sensor circuit.	Gr.2	No
A.7Ab	SERVOPACK Built-in Fan Stopped	The fan inside the SERVOPACK stopped.	Gr.1	Yes
A.810	Encoder Backup Alarm	The power supplies to the encoder all failed and the position data was lost.	Gr.1	No
A.820	Encoder Checksum Alarm	There is an error in the checksum results for encoder memory.	Gr.1	No
A.830	Encoder Battery Alarm	The battery voltage was lower than the specified level after the control power supply was turned ON.	Gr.1	Yes
A.840	Encoder Data Alarm	There is an internal data error in the encoder.	Gr.1	No
A.850	Encoder Overspeed	The encoder was operating at high speed when the power was turned ON.	Gr.1	No
A.860	Encoder Overheated	The internal temperature of encoder is too high.	Gr.1	No
A.861	Motor Overheated	The internal temperature of motor is too high.	Gr.1	No
A.890	Encoder Scale Error	A failure occurred in the linear encoder.	Gr.1	No
A.891	Encoder Module Error	An error occurred in the linear encoder.	Gr.1	No
A.8A0	External Encoder Error	An error occurred in the external encoder.	Gr.1	Yes
A.8A1	External Encoder Module Error	An error occurred in the Serial Converter Unit.	Gr.1	Yes
A.8A2	External Incremental Encoder Sensor Error	An error occurred in the external encoder.	Gr.1	Yes
A.8A3	External Absolute Encoder Position Error	An error occurred in the position data of the external encoder.	Gr.1	Yes
A.8A5	External Encoder Overspeed	An overspeed error occurred in the external encoder.	Gr.1	Yes
A.8A6	External Encoder Overheated	An overheating error occurred in the external encoder.	Gr.1	Yes
A.b33	Current Detection Error 3	An error occurred in the current detection circuit.	Gr.1	No
A.b6A	MECHATROLINK Communications ASIC Error 1	ASIC error 1 occurred in MECHATROLINK communications.	Gr.1	No
A.b6b	MECHATROLINK Communications ASIC Error 2	ASIC error 2 occurred in MECHATROLINK communications.	Gr.2	No
A.bF0	System Alarm 0	Internal program error 0 occurred in the SERVOPACK.	Gr.1	No
A.bF1	System Alarm 1	Internal program error 1 occurred in the SERVOPACK.	Gr.1	No
A.bF2	System Alarm 2	Internal program error 2 occurred in the SERVOPACK.	Gr.1	No
A.bF3	System Alarm 3	Internal program error 3 occurred in the SERVOPACK.	Gr.1	No
A.bF4	System Alarm 4	Internal program error 4 occurred in the SERVOPACK.	Gr.1	No

Continued on next page.

Continued from previous page.

Alarm Number	Alarm Name	Alarm Meaning	Servo-motor Stopping Method	Alarm Reset Possible?
A.C10	Servomotor Out of Control	The Servomotor ran out of control.	Gr. 1	Yes
A.C20	Phase Detection Error	The detection of the phase is not correct.	Gr. 1	No
A.C21	Polarity Sensor Error	An error occurred in the polarity sensor.	Gr. 1	No
A.C22	Phase Information Disagreement	The phase information does not match.	Gr. 1	No
A.C50	Polarity Detection Failure	The polarity detection failed.	Gr. 1	No
A.C51	Overtravel Detected during Polarity Detection	The overtravel signal was detected during polarity detection.	Gr. 1	Yes
A.C52	Polarity Detection Not Completed	The servo was turned ON before the polarity was detected.	Gr. 1	Yes
A.C53	Out of Range of Motion for Polarity Detection	The travel distance exceeded the setting of Pn48E (Polarity Detection Range).	Gr. 1	No
A.C54	Polarity Detection Failure 2	The polarity detection failed.	Gr. 1	No
A.C80	Encoder Clear Error or Multiturn Limit Setting Error	The multiturn data for the absolute encoder was not correctly cleared or set.	Gr. 1	No
A.C90	Encoder Communications Error	Communications between the encoder and SERVOPACK is not possible.	Gr. 1	No
A.C91	Encoder Communications Position Data Acceleration Rate Error	An error occurred in calculating the position data of the encoder.	Gr. 1	No
A.C92	Encoder Communications Timer Error	An error occurred in the communications timer between the encoder and SERVOPACK.	Gr. 1	No
A.CA0	Encoder Parameter Error	The parameters in the encoder are corrupted.	Gr. 1	No
A.Cb0	Encoder Echoback Error	The contents of communications with the encoder are incorrect.	Gr. 1	No
A.CC0	Multiturn Limit Disagreement	Different multiturn limits have been set in the encoder and the SERVOPACK.	Gr. 1	No
A.CF1	Reception Failed Error in Feedback Option Module Communications	Receiving data from the Feedback Option Module failed.	Gr. 1	No
A.CF2	Timer Stopped Error in Feedback Option Module Communications	An error occurred in the timer for communications with the Feedback Option Module.	Gr. 1	No
A.d00	Position Deviation Overflow	The setting of Pn520 (Position Deviation Overflow Alarm Level) was exceeded by the position deviation while the servo was ON.	Gr. 1	Yes
A.d01	Position Deviation Overflow Alarm at Servo ON	The servo was turned ON after the position deviation exceeded the setting of Pn526 (Position Deviation Overflow Alarm Level at Servo ON) while the servo was OFF.	Gr. 1	Yes
A.d02	Position Deviation Overflow Alarm for Speed Limit at Servo ON	If position deviation remains in the deviation counter, the setting of Pn529 or Pn584 (Speed Limit Level at Servo ON) limits the speed when the servo is turned ON. This alarm occurs if a position reference is input and the setting of Pn520 (Position Deviation Overflow Alarm Level) is exceeded before the limit is cleared.	Gr. 2	Yes
A.d10	Motor-Load Position Deviation Overflow	There was too much position deviation between the motor and load during fully-closed loop control.	Gr. 2	Yes

Continued on next page.

Continued from previous page.

Alarm Number	Alarm Name	Alarm Meaning	Servo-motor Stopping Method	Alarm Reset Possible?
A.d30	Position Data Overflow	The position feedback data exceeded $\pm 1,879,048,192$.	Gr.1	No
A.E02	MECHATROLINK Internal Synchronization Error 1	A synchronization error occurred during MECHATROLINK communications with the SERVOPACK.	Gr.1	Yes
A.E40	MECHATROLINK Transmission Cycle Setting Error	The setting of the MECHATROLINK communications transmission cycle is not correct.	Gr.2	Yes
A.E41	MECHATROLINK Communications Data Size Setting Error	The setting of the MECHATROLINK communications data size is not correct.	Gr.2	Yes
A.E42	MECHATROLINK Station Address Setting Error	The setting of the MECHATROLINK station address is not correct.	Gr.2	No
A.E50*	MECHATROLINK Synchronization Error	A synchronization error occurred during MECHATROLINK communications.	Gr.2	Yes
A.E51	MECHATROLINK Synchronization Failed	Synchronization failed during MECHATROLINK communications.	Gr.2	Yes
A.E60*	Reception Error in MECHATROLINK Communications	Communications errors occurred continuously during MECHATROLINK communications.	Gr.2	Yes
A.E61	Synchronization Interval Error in MECHATROLINK Transmission Cycle	An error occurred in the transmission cycle during MECHATROLINK communications.	Gr.2	Yes
A.E63	MECHATROLINK Synchronization Frame Not Received	Synchronization frames were continuously not received during MECHATROLINK communications.	Gr.2	Yes
A.E71	Safety Option Module Detection Failure	Detection of the Safety Option Module failed.	Gr.1	No
A.E72	Feedback Option Module Detection Failure	Detection of the Feedback Option Module failed.	Gr.1	No
A.E74	Unsupported Safety Option Module	An unsupported Safety Option Module was connected.	Gr.1	No
A.Eb1	Safety Function Signal Input Timing Error	An error occurred in the input timing of the safety function signal.	Gr.1	No
A.EC8	Gate Drive Error 1	An error occurred in the gate drive circuit.	Gr.1	No
A.EC9	Gate Drive Error 2	An error occurred in the gate drive circuit.	Gr.1	No
A.Ed1	Command Execution Timeout	A timeout error occurred for a MECHATROLINK command.	Gr.2	Yes
A.F10	Power Supply Line Open Phase	The voltage was low for more than one second for phase R, S, or T when the main power supply was ON.	Gr.2	Yes
A.F50	Servomotor Main Circuit Cable Disconnection	The Servomotor did not operate or power was not supplied to the Servomotor even though the SV_ON (Servo ON) command was input when the Servomotor was ready to receive it.	Gr.1	Yes
FL-1*	System Alarm	An internal program error occurred in the SERVOPACK.	-	No
FL-2*				
FL-3*				
FL-4*				
FL-5*				

Continued on next page.

Continued from previous page.

Alarm Number	Alarm Name	Alarm Meaning	Servo-motor Stopping Method	Alarm Reset Possible?
CPF00	Digital Operator Communications Error 1	Communications were not possible between the Digital Operator (model: JUSP-OP05A-1-E) and the SERVOPACK (e.g., a CPU error occurred).	-	No
CPF01	Digital Operator Communications Error 2			

* These alarms are not stored in the alarm history. They are only displayed on the panel display.

Note: The A.Eb0, A.Eb2 to A.Eb9, and A.EC0 to A.EC2 alarms can occur when a Safety Module is connected. Refer to the following manual for details.

 AC Servo Drive Σ -V-Series/ Σ -V-Series for Large-Capacity Models/ Σ -7-Series User's Manual Safety Module (Manual No.: SIEP C720829 06)

4.2.3 Troubleshooting Alarms

The causes of and corrections for the alarms are given in the following table. Contact your Yaskawa representative if you cannot solve a problem with the correction given in the table.

Alarm Number: Alarm Name	Possible Cause	Confirmation	Correction	Reference
A.020: Parameter Checksum Error (There is an error in the parameter data in the SER- VOPACK.)	The power supply voltage suddenly dropped.	Measure the power supply voltage.	Set the power supply voltage within the specified range, and initialize the parameter settings.	*1
	The power supply was shut OFF while writing parameter settings.	Check the timing of shutting OFF the power supply.	Initialize the parameter settings and then set the parameters again.	*1
	The number of times that parameters were written exceeded the limit.	Check to see if the parameters were frequently changed from the host controller.	The SERVOPACK may be faulty. Replace the SERVOPACK. Reconsider the method for writing the parameters.	-
	A malfunction was caused by noise from the AC power supply, ground, static electricity, or other source.	Turn the power supply to the SERVOPACK OFF and ON again. If the alarm still occurs, noise may be the cause.	Implement countermeasures against noise.	*1
	Gas, water drops, or cutting oil entered the SERVOPACK and caused failure of the internal components.	Check the installation conditions.	The SERVOPACK may be faulty. Replace the SERVOPACK.	-
	A failure occurred in the SERVOPACK.	Turn the power supply to the SERVOPACK OFF and ON again. If the alarm still occurs, the SERVOPACK may have failed.	The SERVOPACK may be faulty. Replace the SERVOPACK.	-
A.021: Parameter Format Error (There is an error in the parameter data format in the SERVOPACK.)	The software version of the SERVOPACK that caused the alarm is older than the software version of the parameters specified to write.	Read the product information to see if the software versions are the same. If they are different, it could be the cause of the alarm.	Write the parameters from another SERVOPACK with the same model and the same software version, and then turn the power OFF and ON again.	*1
	A failure occurred in the SERVOPACK.	-	The SERVOPACK may be faulty. Replace the SERVOPACK.	-
A.022: System Checksum Error (There is an error in the parameter data in the SERVOPACK.)	The power supply voltage suddenly dropped.	Measure the power supply voltage.	The SERVOPACK may be faulty. Replace the SERVOPACK.	-
	The power supply was shut OFF while setting a utility function.	Check the timing of shutting OFF the power supply.	The SERVOPACK may be faulty. Replace the SERVOPACK.	-
	A failure occurred in the SERVOPACK.	Turn the power supply to the SERVOPACK OFF and ON again. If the alarm still occurs, the SERVOPACK may have failed.	The SERVOPACK may be faulty. Replace the SERVOPACK.	-

Continued on next page.

Continued from previous page.

Alarm Number: Alarm Name	Possible Cause	Confirmation	Correction	Reference
A.024: System Alarm (An internal program error occurred in the SERVOPACK.)	A failure occurred in the SERVOPACK.	–	The SERVOPACK may be faulty. Replace the SERVOPACK.	–
A.025: System Alarm (An internal program error occurred in the SERVOPACK.)	A failure occurred in the SERVOPACK.	–	The SERVOPACK may be faulty. Replace the SERVOPACK.	–
A.030: Main Circuit Detector Error	A failure occurred in the SERVOPACK.	–	The SERVOPACK may be faulty. Replace the SERVOPACK.	–
A.040: Parameter Setting Error (A parameter setting is outside of the setting range.)	The SERVOPACK and Servomotor capacities do not match each other.	Check the combination of the SERVOPACK and Servomotor capacities.	Select a proper combination of SERVOPACK and Servomotor capacities.	*1
	A failure occurred in the SERVOPACK.	–	The SERVOPACK may be faulty. Replace the SERVOPACK.	–
	A parameter setting is outside of the setting range.	Check the setting ranges of the parameters that have been changed.	Set the parameters to values within the setting ranges.	–
	The electronic gear ratio is outside of the setting range.	Check the electronic gear ratio. The ratio must be within the following range: $0.001 < (Pn20E/Pn210) < 64,000$.	Set the electronic gear ratio in the following range: $0.001 < (Pn20E/Pn210) < 64,000$.	*1
A.041: Encoder Output Pulse Setting Error	The setting of Pn212 (Number of Encoder Output Pulses) or Pn281 (Encoder Output Resolution) is outside of the setting range or does not satisfy the setting conditions.	Check the setting of Pn212 or Pn281.	Set Pn212 or Pn281 to an appropriate value.	*1

Continued on next page.

Continued from previous page.

Alarm Number: Alarm Name	Possible Cause	Confirmation	Correction	Reference
A.042: Parameter Combination Error	The speed of program jogging went below the setting range when the electronic gear ratio (Pn20E/ Pn210) or the Servomotor was changed.	Check to see if the detection conditions*2 are satisfied.	Decrease the setting of the electronic gear ratio (Pn20E/Pn210).	*1
	The speed of program jogging went below the setting range when Pn533 or Pn585 (Program Jogging Movement Speed) was changed.	Check to see if the detection conditions*2 are satisfied.	Increase the setting of Pn533 or Pn585.	*1
	The movement speed of advanced autotuning went below the setting range when the electronic gear ratio (Pn20E/ Pn210) or the Servomotor was changed.	Check to see if the detection conditions*3 are satisfied.	Decrease the setting of the electronic gear ratio (Pn20E/Pn210).	*1
A.044: Semi-Closed/ Fully-Closed Loop Control Parameter Setting Error	The setting of the Fully-Closed Module does not match the setting of Pn002 = n.X□□□ (External Encoder Usage).	Check the setting of Pn002 = n.X□□□.	Make sure that the setting of the Fully-closed Module agrees with the setting of Pn002 = n.X□□□.	*1
A.04A: Parameter Setting Error 2	For 4-byte parameter bank members, there are two consecutive members with nothing registered.	–	Change the number of bytes for bank members to an appropriate value.	–
	The total amount of bank data exceeds 64 (Pn900 × Pn901 > 64).	–	Reduce the total amount of bank data to 64 or less.	–
A.050: Combination Error (The capacities of the SERVOPACK and Servomotor do not match.)	The SERVOPACK and Servomotor capacities do not match each other.	Check the capacities to see if they satisfy the following condition: $1/4 \leq \frac{\text{Servomotor capacity}}{\text{SERVOPACK capacity}} \leq 4$	Select a proper combination of the SERVOPACK and Servomotor capacities.	*1
	A failure occurred in the encoder.	Replace the encoder and check to see if the alarm still occurs.	Replace the Servomotor or encoder.	–
	A failure occurred in the SERVOPACK.	–	The SERVOPACK may be faulty. Replace the SERVOPACK.	–
A.051: Unsupported Device Alarm	The motor parameter file was not written to the linear encoder. (This applies only when not using a Serial Converter Unit.)	Check to see if the motor parameter file was written to the linear encoder.	Write the motor parameter file to the linear encoder.	*1
	An unsupported Serial Converter Unit or encoder (e.g., an external encoder) is connected to the SERVOPACK.	Check the product combination specifications.	Change to a correct combination of models.	–

Continued on next page.

Continued from previous page.

Alarm Number: Alarm Name	Possible Cause	Confirmation	Correction	Reference
A.070: Motor Type Change Detected (The connected motor is a differ- ent type of motor from the previ- ously connected motor.)	A Rotary Servomotor was removed and a Linear Servomotor was connected.	–	Set the parameters for a Linear Servomotor and reset the motor type alarm. Then, turn the power supply to the SER- VOPACK OFF and ON again.	*1
	A Linear Servomotor was removed and a Rotary Servomotor was connected.	–	Set the parameters for a Rotary Servomotor and reset the motor type alarm. Then, turn the power supply to the SER- VOPACK OFF and ON again.	*1
A.080: Linear Encoder Pitch Setting Error	The setting of Pn282 (Linear Encoder Scale Pitch) has not been changed from the default setting.	Check the setting of Pn282.	Correct the setting of Pn282.	*1
A.0b0: Invalid Servo ON Command Alarm	The SV_ON (Servo ON) command was sent from the host controller after a util- ity function that turns ON the Servomotor was executed.	–	Turn the power supply to the SERVOPACK OFF and ON again. Or, execute a software reset.	*1

Continued on next page.

Continued from previous page.

Alarm Number: Alarm Name	Possible Cause	Confirmation	Correction	Reference
A.100: Overcurrent Detected (An overcurrent flowed through the power trans- former or the heat sink overheated.)	The Main Circuit Cable is not wired correctly or there is faulty contact.	Check the wiring.	Correct the wiring.	*1
	There is a short-circuit or ground fault in a Main Circuit Cable.	Check for short-circuits across Servomotor phases U, V, and W, or between the ground and Servomotor phases U, V, and W.	The cable may be short-circuited. Replace the cable.	*1
	There is a short-circuit or ground fault inside the Servomotor.	Check for short-circuits across Servomotor phases U, V, and W, or between the ground and Servomotor phases U, V, or W.	The Servomotor may be faulty. Replace the Servomotor.	*1
	There is a short-circuit or ground fault inside the SERVOPACK.	Check for short-circuits across the Servomotor connection terminals U, V, and W on the SERVOPACK, or between the ground and terminals U, V, or W.	The SERVOPACK may be faulty. Replace the SERVOPACK.	*1
	The regenerative resistor is not wired correctly or there is faulty contact.	Check the wiring.	Correct the wiring.	*1
	The dynamic brake (DB, emergency stop executed from the SERVOPACK) was frequently activated, or a DB overload alarm occurred.	Check the power consumed by the DB resistor to see how frequently the DB is being used. Or, check the alarm display to see if a DB overload alarm (A.730 or A.731) has occurred.	Change the SERVOPACK model, operating methods, or the mechanisms so that the dynamic brake does not need to be used so frequently.	-
	The regenerative processing capacity was exceeded.	Check the regenerative load ratio in the SigmaWin+ Motion Monitor Tab Page to see how frequently the regenerative resistor is being used.	Recheck the operating conditions and load.	*4
	The SERVOPACK regenerative resistance is too small.	Check the regenerative load ratio in the SigmaWin+ Motion Monitor Tab Page to see how frequently the regenerative resistor is being used.	Change the regenerative resistance to a value larger than the SERVOPACK minimum allowable resistance.	*4

Continued on next page.

4.2 SERVOPACKs with MECHATROLINK-III Communications References

4.2.3 Troubleshooting Alarms

Continued from previous page.

Alarm Number: Alarm Name	Possible Cause	Confirmation	Correction	Reference
A.100: Overcurrent Detected (An overcurrent flowed through the power trans- former or the heat sink overheated.)	A heavy load was applied while the Ser- vomotor was stopped or running at a low speed.	Check to see if the operating conditions exceed Servo Drive specifications.	Reduce the load applied to the Servomotor. Or, increase the operating speed.	-
	A malfunction was caused by noise.	Improve the noise envi- ronment, e.g. by improving the wiring or installation conditions, and check to see if the alarm still occurs.	Implement countermea- sures against noise, such as correct wiring of the FG. Use an FG wire size equivalent to the SERVO- PACK's main circuit wire size.	-
	A failure occurred in the SERVOPACK.	-	Turn the power supply to the SERVOPACK OFF and ON again. If an alarm still occurs, the SERVOPACK may be faulty. Replace the SERVOPACK.	-
A.101: Motor Overcur- rent Detected (The current to the motor exceeded the allowable cur- rent.)	The Main Circuit Cable is not wired correctly or there is faulty contact.	Check the wiring.	Correct the wiring.	*1
	There is a short-circuit or ground fault in a Main Circuit Cable.	Check for short-circuits across cable phases U, V, and W, or between the ground and cable phases U, V, and W.	The cable may be short- circuited. Replace the cable.	*1
	There is a short-circuit or ground fault inside the Servomotor.	Check for short-circuits across Servomotor phases U, V, and W, or between the ground and Servomotor phases U, V, or W.	The Servomotor may be faulty. Replace the Servo- motor.	*1
	There is a short-circuit or ground fault inside the SERVOPACK.	Check for short-circuits across the Servomotor connection terminals U, V, and W on the SER- VOPACK, or between the ground and termi- nals U, V, or W.	The SERVOPACK may be faulty. Replace the SER- VOPACK.	*1
	A heavy load was applied while the Ser- vomotor was stopped or running at a low speed.	Check to see if the operating conditions exceed Servo Drive specifications.	Reduce the load applied to the Servomotor. Or, increase the operating speed.	-
	A malfunction was caused by noise.	Improve the noise envi- ronment, e.g. by improving the wiring or installation conditions, and check to see if the alarm still occurs.	Implement countermea- sures against noise, such as correct wiring of the FG. Use an FG wire size equivalent to the SERVO- PACK's main circuit wire size.	-
	A failure occurred in the SERVOPACK.	-	Turn the power supply to the SERVOPACK OFF and ON again. If an alarm still occurs, the SERVOPACK may be faulty. Replace the SERVOPACK.	-

Continued on next page.

Continued from previous page.

Alarm Number: Alarm Name	Possible Cause	Confirmation	Correction	Reference
A.300: Regeneration Error	Pn600 (Regenerative Resistor Capacity) is not set to 0 and an External Regenerative Resistor is not connected to one of the following SERVOPACKs: SGD7S-R70A, -R90A, -1R6A, -2R8A, or -330A.	Check to see if an External Regenerative Resistor is connected and check the setting of Pn600.	Connect an External Regenerative Resistor, or set Pn600 (Regenerative Resistor Capacity) to 0 (setting unit: $\times 10$ W) if no Regenerative Resistor is required.	*1
	An External Regenerative Resistor is not connected to one of the following SERVOPACKs: SGD7S-470A, -550A, -590A, or -780A.	Check to see if an External Regenerative Resistor or a Regenerative Resistor Unit is connected and check the setting of Pn600.	Connect an External Regenerative Resistor and set Pn600 to an appropriate value, or connect a Regenerative Resistor Unit and set Pn600 to 0.	*1
	The jumper between the regenerative resistor terminals (B2 and B3) was removed from one of the following SERVOPACKs: SGD7S-3R8A, SGD7S-5R5A, SGD7S-7R6A, SGD7S-120A, SGD7S-180A, or SGD7S-200A.	Check to see if the jumper is connected between power supply terminals B2 and B3.	Correctly connect a jumper.	*1
	The External Regenerative Resistor is not wired correctly, or was removed or disconnected.	Check the wiring of the External Regenerative Resistor.	Correct the wiring of the External Regenerative Resistor.	*1
	A failure occurred in the SERVOPACK.	–	While the main circuit power supply is OFF, turn the control power supply to the SERVOPACK OFF and ON again. If an alarm still occurs, the SERVOPACK may be faulty. Replace the SERVOPACK.	–

Continued on next page.

Continued from previous page.

Alarm Number: Alarm Name	Possible Cause	Confirmation	Correction	Reference
A.320: Regenerative Overload	The power supply voltage exceeded the specified range.	Measure the power supply voltage.	Set the power supply voltage within the specified range.	–
	The external regenerative resistance value or regenerative resistor capacity is too small, or there has been a continuous regeneration state.	Check the operating conditions or the capacity using the SigmaJunmaSize+ Capacity Selection Software or other means.	Change the regenerative resistance value or capacity. Reconsider the operating conditions using the SigmaJunmaSize+ Capacity Selection Software or other means.	*4
	There was a continuous regeneration state because a negative load was continuously applied.	Check the load applied to the Servomotor during operation.	Reconsider the system including the servo, machine, and operating conditions.	–
	The setting of Pn600 (Regenerative Resistor Capacity) is smaller than the capacity of the External Regenerative Resistor.	Check it see if a Regenerative Resistor is connected and check the setting of Pn600.	Correct the setting of Pn600.	*1
	The setting of Pn603 (Regenerative Resistance) is smaller than the capacity of the External Regenerative Resistor.	Check to see if a Regenerative Resistor is connected and check the setting of Pn603.	Correct the setting of Pn603.	*1
	The external regenerative resistance is too high.	Check the regenerative resistance.	Change the regenerative resistance to a correct value or use an External Regenerative Resistor of an appropriate capacity.	*4
	A failure occurred in the SERVOPACK.	–	The SERVOPACK may be faulty. Replace the SERVOPACK.	–

Continued on next page.

Continued from previous page.

Alarm Number: Alarm Name	Possible Cause	Confirmation	Correction	Reference
A.330: Main Circuit Power Supply Wiring Error (Detected when the main circuit power supply is turned ON.)	The regenerative resistor was disconnected when the SERVOPACK power supply voltage was high.	Measure the resistance of the regenerative resistor using a measuring instrument.	If you are using the regenerative resistor built into the SERVOPACK, replace the SERVOPACK. If you are using an External Regenerative Resistor, replace the External Regenerative Resistor.	–
	DC power was supplied when an AC power supply input was specified in the settings.	Check the power supply to see if it is a DC power supply.	Correct the power supply setting to match the actual power supply.	*1
	AC power was supplied when a DC power supply input was specified in the settings.	Check the power supply to see if it is an AC power supply.	Correct the power supply setting to match the actual power supply.	*1
	Pn600 (Regenerative Resistor Capacity) is not set to 0 and an External Regenerative Resistor is not connected to one of the following SERVO-PACKs: SGD7S-R70A, SGD7S-R90A, SGD7S-1R6A, or SGD7S-2R8A.	Check it see if an External Regenerative Resistor is connected and check the setting of Pn600.	Connect an External Regenerative Resistor, or if an External Regenerative Resistor is not required, set Pn600 to 0.	*1
	A failure occurred in the SERVOPACK.	–	The SERVOPACK may be faulty. Replace the SERVOPACK.	–

Continued on next page.

Continued from previous page.

Alarm Number: Alarm Name	Possible Cause	Confirmation	Correction	Reference
A.400: Overvoltage (Detected in the main circuit power supply section of the SERVOPACK.)	The power supply voltage exceeded the specified range.	Measure the power supply voltage.	Set the AC/DC power supply voltage within the specified range.	-
	The power supply is not stable or was influenced by a lightning surge.	Measure the power supply voltage.	Improve the power supply conditions, install a surge absorber, and then turn the power supply OFF and ON again. If an alarm still occurs, the SERVOPACK may be faulty. Replace the SERVOPACK.	-
	The voltage for AC power supply was too high during acceleration or deceleration.	Check the power supply voltage and the speed and torque during operation.	Set the AC power supply voltage within the specified range.	-
	The external regenerative resistance is too high for the operating conditions.	Check the operating conditions and the regenerative resistance.	Select a regenerative resistance value that is appropriate for the operating conditions and load.	*4
	The moment of inertia ratio or mass ratio exceeded the allowable value.	Check to see if the moment of inertia ratio or mass ratio is within the allowable range.	Increase the deceleration time, or reduce the load.	-
	A failure occurred in the SERVOPACK.	-	While the main circuit power supply is OFF, turn the control power supply to the SERVOPACK OFF and ON again. If an alarm still occurs, the SERVOPACK may be faulty. Replace the SERVOPACK.	-
A.410: Undervoltage (Detected in the main circuit power supply section of the SERVOPACK.)	The power supply voltage went below the specified range.	Measure the power supply voltage.	Set the power supply voltage within the specified range.	-
	The power supply voltage dropped during operation.	Measure the power supply voltage.	Increase the power supply capacity.	-
	A momentary power interruption occurred.	Measure the power supply voltage.	If you have changed the setting of Pn509 (Momentary Power Interruption Hold Time), decrease the setting.	*1
	The SERVOPACK fuse is blown out.	-	Replace the SERVOPACK and connect a reactor to the DC reactor terminals (⊖1 and ⊖2) on the SERVOPACK.	-
	A failure occurred in the SERVOPACK.	-	The SERVOPACK may be faulty. Replace the SERVOPACK.	-

Continued on next page.

Continued from previous page.

Alarm Number: Alarm Name	Possible Cause	Confirmation	Correction	Reference
A.510: Overspeed (The motor exceeded the maximum speed.)	The order of phases U, V, and W in the motor wiring is not correct.	Check the wiring of the Servomotor.	Make sure that the Servomotor is correctly wired.	–
	A reference value that exceeded the over-speed detection level was input.	Check the input reference.	Reduce the reference value. Or, adjust the gain.	–
	The motor exceeded the maximum speed.	Check the waveform of the motor speed.	Reduce the speed reference input gain and adjust the servo gain. Or, reconsider the operating conditions.	
	A failure occurred in the SERVOPACK.	–	The SERVOPACK may be faulty. Replace the SERVOPACK.	–
A.511: Encoder Output Pulse Overspeed	The encoder output pulse frequency exceeded the limit.	Check the encoder output pulse setting.	Decrease the setting of Pn212 (Number of Encoder Output Pulses) or Pn281 (Encoder Output Resolution).	*1
	The encoder output pulse frequency exceeded the limit because the motor speed was too high.	Check the encoder output pulse setting and the motor speed.	Reduce the motor speed.	–
A.520: Vibration Alarm	Abnormal oscillation was detected in the motor speed.	Check for abnormal motor noise, and check the speed and torque waveforms during operation.	Reduce the motor speed. Or, reduce the setting of Pn100 (Speed Loop Gain).	*1
	The setting of Pn103 (Moment of Inertia Ratio) is greater than the actual moment of inertia or was greatly changed.	Check the moment of inertia ratio or mass ratio.	Set Pn103 (Moment of Inertia Ratio) to an appropriate value.	*1
	The vibration detection level (Pn312 or Pn384) is not suitable.	Check that the vibration detection level (Pn312 or Pn384) is suitable.	Set a suitable vibration detection level (Pn312 or Pn384).	*1
A.521: Autotuning Alarm (Vibration was detected while executing the custom tuning, Easy FFT, or the tuning-less function.)	The Servomotor vibrated considerably while performing the tuning-less function.	Check the waveform of the motor speed.	Reduce the load so that the moment of inertia ratio is within the allowable value. Or increase the load level or reduce the rigidity level in the tuning-less level settings.	*1
	The Servomotor vibrated considerably while performing custom tuning or Easy FFT.	Check the waveform of the motor speed.	Check the operating procedure of corresponding function and implement corrections.	*1
A.550: Maximum Speed Setting Error	The setting of Pn385 (Maximum Motor Speed) is greater than the maximum speed.	Check the setting of Pn385, and the upper limits of the maximum motor speed setting and the encoder output resolution setting.	Set Pn385 to a value that does not exceed the maximum motor speed.	*1

Continued on next page.

Continued from previous page.

Alarm Number: Alarm Name	Possible Cause	Confirmation	Correction	Reference
A.710: Instantaneous Overload A.720: Continuous Overload	The wiring is not correct or there is a faulty contact in the motor or encoder wiring.	Check the wiring.	Make sure that the Servomotor and encoder are correctly wired.	*1
	Operation was performed that exceeded the overload protection characteristics.	Check the motor overload characteristics and Run command.	Reconsider the load and operating conditions. Or, increase the motor capacity.	-
	An excessive load was applied during operation because the Servomotor was not driven due to mechanical problems.	Check the operation reference and motor speed.	Correct the mechanical problem.	-
	There is an error in the setting of Pn282 (Linear Encoder Scale Pitch).	Check the setting of Pn282.	Correct the setting of Pn282.	*1
	There is an error in the setting of Pn080 = n.□□X□ (Motor Phase Sequence Selection).	Check the setting of Pn080 = n.□□X□.	Set Pn080 = n.□□X□ to an appropriate value.	*1
	A failure occurred in the SERVOPACK.	-	The SERVOPACK may be faulty. Replace the SERVOPACK.	-
A.730 and A.731: Dynamic Brake Overload (An excessive power consumption by the dynamic brake was detected.)	The Servomotor was rotated by an external force.	Check the operation status.	Implement measures to ensure that the motor will not be rotated by an external force.	-
	When the Servomotor was stopped with the dynamic brake, the rotational or linear kinetic energy exceeded the capacity of the dynamic brake resistor.	Check the power consumed by the DB resistor to see how frequently the DB is being used.	Reconsider the following: <ul style="list-style-type: none"> • Reduce the Servomotor command speed. • Decrease the moment of inertia ratio or mass ratio. • Reduce the frequency of stopping with the dynamic brake. 	-
	A failure occurred in the SERVOPACK.	-	The SERVOPACK may be faulty. Replace the SERVOPACK.	-
A.740: Inrush Current Limiting Resistor Overload (The main circuit power supply was frequently turned ON and OFF.)	The allowable frequency of the inrush current limiting resistor was exceeded when the main circuit power supply was turned ON and OFF.	-	Reduce the frequency of turning the main circuit power supply ON and OFF.	-
	A failure occurred in the SERVOPACK.	-	The SERVOPACK may be faulty. Replace the SERVOPACK.	-

Continued on next page.

Continued from previous page.

Alarm Number: Alarm Name	Possible Cause	Confirmation	Correction	Reference
A.7A1: Internal Temperature Error 1 (Control Board Temperature Error)	The surrounding temperature is too high.	Check the surrounding temperature using a thermostat. Or, check the operating status with the SERVOPACK installation environment monitor.	Decrease the surrounding temperature by improving the SERVOPACK installation conditions.	*1
	An overload alarm was reset by turning OFF the power supply too many times.	Check the alarm display to see if there is an overload alarm.	Change the method for resetting the alarm.	–
	There was an excessive load or operation was performed that exceeded the regenerative processing capacity.	Use the accumulated load ratio to check the load during operation, and use the regenerative load ratio to check the regenerative processing capacity.	Reconsider the load and operating conditions.	–
	The SERVOPACK installation orientation is not correct or there is insufficient space around the SERVOPACK.	Check the SERVOPACK installation conditions.	Install the SERVOPACK according to specifications.	*1
	A failure occurred in the SERVOPACK.	–	The SERVOPACK may be faulty. Replace the SERVOPACK.	–
A.7A2: Internal Temperature Error 2 (Power Board Temperature Error)	The surrounding temperature is too high.	Check the surrounding temperature using a thermostat. Or, check the operating status with the SERVOPACK installation environment monitor.	Decrease the surrounding temperature by improving the SERVOPACK installation conditions.	*1
	An overload alarm was reset by turning OFF the power supply too many times.	Check the alarm display to see if there is an overload alarm.	Change the method for resetting the alarm.	–
	There was an excessive load or operation was performed that exceeded the regenerative processing capacity.	Use the accumulated load ratio to check the load during operation, and use the regenerative load ratio to check the regenerative processing capacity.	Reconsider the load and operating conditions.	–
	The SERVOPACK installation orientation is not correct or there is insufficient space around the SERVOPACK.	Check the SERVOPACK installation conditions.	Install the SERVOPACK according to specifications.	*1
	A failure occurred in the SERVOPACK.	–	The SERVOPACK may be faulty. Replace the SERVOPACK.	–
A.7A3: Internal Temperature Sensor Error (An error occurred in the temperature sensor circuit.)	A failure occurred in the SERVOPACK.	–	The SERVOPACK may be faulty. Replace the SERVOPACK.	–

Continued on next page.

Continued from previous page.

Alarm Number: Alarm Name	Possible Cause	Confirmation	Correction	Reference
A.7Ab: SERVOPACK Built-in Fan Stopped	The fan inside the SERVOPACK stopped.	Check for foreign matter inside the SERVOPACK.	Remove foreign matter from the SERVOPACK. If an alarm still occurs, the SERVOPACK may be faulty. Replace the SERVOPACK.	–
A.810: Encoder Backup Alarm (Detected at the encoder, but only when an absolute encoder is used.)	The power to the absolute encoder was turned ON for the first time.	Check to see if the power supply was turned ON for the first time.	Set up the encoder.	*1
	The Encoder Cable was disconnected and then connected again.	Check to see if the power supply was turned ON for the first time.	Check the encoder connection and set up the encoder.	*1
	Power is not being supplied both from the control power supply (+5 V) from the SERVOPACK and from the battery power supply.	Check the encoder connector battery and the connector status.	Replace the battery or implement similar measures to supply power to the encoder, and set up the encoder.	*1
	A failure occurred in the absolute encoder.	–	If the alarm still occurs after setting up the encoder again, replace the Servomotor.	–
A.820: Encoder Check-sum Alarm (Detected at the encoder.)	A failure occurred in the encoder.	–	<p>■ When Using an Absolute Encoder Set up the encoder again. If the alarm still occurs, the Servomotor may be faulty. Replace the Servomotor.</p> <p>■ When Using a Single-turn Absolute Encoder or Incremental Encoder</p> <ul style="list-style-type: none"> • The Servomotor may be faulty. Replace the Servomotor. • The linear encoder may be faulty. Replace the linear encoder. 	*1
	A failure occurred in the SERVOPACK.	–	The SERVOPACK may be faulty. Replace the SERVOPACK.	–
A.830: Encoder Battery Alarm (The absolute encoder battery voltage was lower than the specified level.)	The battery connection is faulty or a battery is not connected.	Check the battery connection.	Correct the battery connection.	*1
	The battery voltage is lower than the specified value (2.7 V).	Measure the battery voltage.	Replace the battery.	*1
	A failure occurred in the SERVOPACK.	–	The SERVOPACK may be faulty. Replace the SERVOPACK.	–

Continued on next page.

Continued from previous page.

Alarm Number: Alarm Name	Possible Cause	Confirmation	Correction	Reference
A.840: Encoder Data Alarm (Detected at the encoder.)	The encoder malfunc- tioned.	–	Turn the power supply to the SERVOPACK OFF and ON again. If an alarm still occurs, the Servomotor or linear encoder may be faulty. Replace the Servo- motor or linear encoder.	–
	An error occurred in reading data from the linear encoder.	–	The linear encoder is not mounted within an appropri- ate tolerance. Correct the mounting of the linear encoder.	–
	Excessive speed occurred in the linear encoder.	–	Control the motor speed within the range specified by the linear encoder manufacturer and then turn ON the control power supply.	–
	The encoder malfunc- tioned due to noise.	–	Correct the wiring around the encoder by separating the Encoder Cable from the Servomotor Main Cir- cuit Cable or by ground- ing the encoder.	–
	The polarity sensor is not wired correctly.	Check the wiring of the polarity sensor.	Correct the wiring of the polarity sensor.	–
	The polarity sensor failed.	–	Replace the polarity sen- sor.	–
A.850: Encoder Over- speed (Detected at the encoder when the control power supply is turned ON.)	Rotary Servomotor: The Servomotor speed was 200 min ⁻¹ or higher when the control power supply was turned ON.	Check the motor speed when the power supply is turned ON.	Reduce the Servomotor speed to a value less than 200 min ⁻¹ , and turn ON the control power supply.	–
	Linear Servomotor: The Servomotor exceeded the speci- fied speed when the control power supply was turned ON.	Check the motor speed when the power supply is turned ON.	Control the motor speed within the range specified by the linear encoder manufacturer and then turn ON the control power supply.	–
	A failure occurred in the encoder.	–	Turn the power supply to the SERVOPACK OFF and ON again. If an alarm still occurs, the Servomotor or linear encoder may be faulty. Replace the Servo- motor or linear encoder.	–
	A failure occurred in the SERVOPACK.	–	Turn the power supply to the SERVOPACK OFF and ON again. If an alarm still occurs, the SERVOPACK may be faulty. Replace the SERVOPACK.	–

Continued on next page.

Continued from previous page.

Alarm Number: Alarm Name	Possible Cause	Confirmation	Correction	Reference
A.860: Encoder Overheated (Detected at the encoder, but only when an absolute encoder is used.)	The surrounding air temperature around the Servomotor is too high.	Measure the surrounding air temperature around the Servomotor.	Reduce the surrounding air temperature of the Servomotor to 40°C or less.	-
	The Servomotor load is greater than the rated load.	Use the accumulated load ratio to check the load.	Operate the Servo Drive so that the motor load remains within the specified range.	*1
	A failure occurred in the encoder.	-	Turn the power supply to the SERVOPACK OFF and ON again. If an alarm still occurs, the Servomotor or absolute linear encoder may be faulty. Replace the Servomotor or absolute linear encoder.	-
	A failure occurred in the SERVOPACK.	-	Turn the power supply to the SERVOPACK OFF and ON again. If an alarm still occurs, the SERVOPACK may be faulty. Replace the SERVOPACK.	-
A.861: Motor Overheated	The surrounding temperature around the Servomotor is too high.	Measure the surrounding temperature around the Servomotor.	Reduce the surrounding air temperature of the Servomotor to 40° or less.	-
	The motor load is greater than the rated load.	Check the load with the accumulated load ratio on the Motion Monitor Tab Page on the SigmaWin+.	Operate the Servo Drive so that the motor load remains within the specified range.	*1
	A failure occurred in the Serial Converter Unit.	-	Turn the power supply to the SERVOPACK OFF and ON again. If an alarm still occurs, the Serial Converter Unit may be faulty. Replace the Serial Converter Unit.	-
	A failure occurred in the SERVOPACK.	-	Turn the power supply to the SERVOPACK OFF and ON again. If an alarm still occurs, the SERVOPACK may be faulty. Replace the SERVOPACK.	-
A.890: Encoder Scale Error	A failure occurred in the linear encoder.	-	The linear encoder may be faulty. Replace the linear encoder.	-
A.891: Encoder Module Error	A failure occurred in the linear encoder.	-	Turn the power supply to the SERVOPACK OFF and ON again. If an alarm still occurs, the linear encoder may be faulty. Replace the linear encoder.	-
A.8A0: External Encoder Error	Setting the origin of the absolute linear encoder failed because the motor moved.	Before you set the origin, use the fully-closed feedback pulse counter to confirm that the motor is not moving.	The motor must be stopped while setting the origin position.	*1
	A failure occurred in the external encoder.	-	Replace the external encoder.	-

Continued on next page.

Continued from previous page.

Alarm Number: Alarm Name	Possible Cause	Confirmation	Correction	Reference
A.8A1: External Encoder Module Error	A failure occurred in the external encoder.	–	Replace the external encoder.	–
	A failure occurred in the Serial Converter Unit.	–	Replace the Serial Converter Unit.	–
A.8A2: External Incremental Encoder Sensor Error	A failure occurred in the external encoder.	–	Replace the external encoder.	–
A.8A3: External Absolute Encoder Position Error	A failure occurred in the external absolute encoder.	–	The external absolute encoder may be faulty. Refer to the encoder manufacturer's instruction manual for corrections.	–
A.8A5: External Encoder Overspeed	An overspeed error was detected in the external encoder.	Check the maximum speed of the external encoder.	Keep the external encoder below its maximum speed.	–
A.8A6: External Encoder Overheated	An overheating error was detected in the external encoder.	–	Replace the external encoder.	–
A.b33: Current Detection Error 3	A failure occurred in the current detection circuit.	–	Turn the power supply to the SERVOPACK OFF and ON again. If an alarm still occurs, the SERVOPACK may be faulty. Replace the SERVOPACK.	–
A.b6A: MECHATROLINK Communications ASIC Error 1	There is a fault in the SERVOPACK MECHATROLINK communications section.	–	Turn the power supply to the SERVOPACK OFF and ON again. If an alarm still occurs, the SERVOPACK may be faulty. Replace the SERVOPACK.	–
A.b6b: MECHATROLINK Communications ASIC Error 2	A malfunction occurred in the MECHATROLINK communications section due to noise.	–	Implement the following countermeasures against noise. <ul style="list-style-type: none"> • Check the MECHATROLINK Communications Cable and FG wiring. • Attach a ferrite core to the MECHATROLINK Communications Cable. 	–
	There is a fault in the SERVOPACK MECHATROLINK communications section.	–	Turn the power supply to the SERVOPACK OFF and ON again. If an alarm still occurs, the SERVOPACK may be faulty. Replace the SERVOPACK.	–
A.bF0: System Alarm 0	A failure occurred in the SERVOPACK.	–	Turn the power supply to the SERVOPACK OFF and ON again. If an alarm still occurs, the SERVOPACK may be faulty. Replace the SERVOPACK.	–
A.bF1: System Alarm 1	A failure occurred in the SERVOPACK.	–	Turn the power supply to the SERVOPACK OFF and ON again. If an alarm still occurs, the SERVOPACK may be faulty. Replace the SERVOPACK.	–

Continued on next page.

Continued from previous page.

Alarm Number: Alarm Name	Possible Cause	Confirmation	Correction	Reference
A.bF2: System Alarm 2	A failure occurred in the SERVOPACK.	—	Turn the power supply to the SERVOPACK OFF and ON again. If an alarm still occurs, the SERVOPACK may be faulty. Replace the SERVOPACK.	—
A.bF3: System Alarm 3	A failure occurred in the SERVOPACK.	—	Turn the power supply to the SERVOPACK OFF and ON again. If an alarm still occurs, the SERVOPACK may be faulty. Replace the SERVOPACK.	—
A.bF4: System Alarm 4	A failure occurred in the SERVOPACK.	—	Turn the power supply to the SERVOPACK OFF and ON again. If an alarm still occurs, the SERVOPACK may be faulty. Replace the SERVOPACK.	—
A.C10: Servomotor Out of Control (Detected when the servo is turned ON.)	The order of phases U, V, and W in the motor wiring is not correct.	Check the Servomotor wiring.	Make sure that the Servomotor is correctly wired.	—
	There is an error in the setting of Pn080 = n.□□X□ (Motor Phase Sequence Selection).	Check the setting of Pn080 = n.□□X□.	Set Pn080 = n.□□X□ to an appropriate value.	*1
	A failure occurred in the encoder.	—	If the motor wiring is correct and an alarm still occurs after turning the power supply OFF and ON again, the Servomotor or linear encoder may be faulty. Replace the Servomotor or linear encoder.	—
	A failure occurred in the SERVOPACK.	—	Turn the power supply to the SERVOPACK OFF and ON again. If an alarm still occurs, the SERVOPACK may be faulty. Replace the SERVOPACK.	—
A.C20: Phase Detection Error	The linear encoder signal level is too low.	Check the voltage of the linear encoder signal.	Fine-tune the mounting of the scale head. Or, replace the linear encoder.	—
	The count-up direction of the linear encoder does not match the forward direction of the Moving Coil in the motor.	Check the setting of Pn080 = n.□□X□ (Motor Phase Sequence Selection). Check the installation orientation for the linear encoder and Moving Coil.	Change the setting of Pn080 = n.□□X□. Correctly reinstall the linear encoder or Moving Coil.	*1
	The polarity sensor signal is being affected by noise.	—	Correct the FG wiring. Implement countermeasures against noise for the polarity sensor wiring.	—

Continued on next page.

Continued from previous page.

Alarm Number: Alarm Name	Possible Cause	Confirmation	Correction	Reference
A.C21: Polarity Sensor Error	The polarity sensor is protruding from the Magnetic Way of the motor.	Check the polarity sensor.	Correctly reinstall the Moving Coil or Magnetic Way of the motor.	–
	The setting of Pn282 (Linear Encoder Scale Pitch) is not correct.	Check the setting of Pn282 (Linear Encoder Scale Pitch).	Check the specifications of the linear encoder and set a correct value.	*1
	The polarity sensor is not wired correctly.	Check the wiring of the polarity sensor.	Correct the wiring of the polarity sensor.	–
	The polarity sensor failed.	–	Replace the polarity sensor.	–
A.C22: Phase Information Disagreement	The SERVOPACK phase information is different from the linear encoder phase information.	–	Perform polarity detection.	*1

Continued on next page.

Continued from previous page.

Alarm Number: Alarm Name	Possible Cause	Confirmation	Correction	Reference
A.C50: Polarity Detection Failure	The parameter settings are not correct.	Check the linear encoder specifications and feedback signal status.	The settings of Pn282 (Linear Encoder Scale Pitch) and Pn080 = n.□□X□ (Motor Phase Sequence Selection) may not match the installation. Set the parameters to correct values.	*1
	There is noise on the scale signal.	Check to make sure that the frame grounds of the Serial Converter Unit and Servomotor are connected to the FG terminal on the SERVOPACK and that the FG terminal on the SERVOPACK is connected to the frame ground on the power supply. And, confirm that the shield is properly processed on the Linear Encoder Cable. Check to see if the detection reference is repeatedly output in one direction.	Implement appropriate countermeasures against noise for the Linear Encoder Cable.	-
	An external force was applied to the Moving Coil of the motor.	-	The polarity cannot be properly detected if the detection reference is 0 and the speed feedback is not 0 because of an external force, such as cable tension, applied to the Moving Coil. Implement measures to reduce the external force so that the speed feedback goes to 0. If the external force cannot be reduced, increase the setting of Pn481 (Polarity Detection Speed Loop Gain).	-
	The linear encoder resolution is too low.	Check the linear encoder scale pitch to see if it is within 100 μm.	If the linear encoder scale pitch is 100 μm or higher, the SERVOPACK cannot detect the correct speed feedback. Use a linear encoder scale pitch with higher resolution. (We recommend a pitch of 40 μm or less.) Or, increase the setting of Pn485 (Polarity Detection Reference Speed). However, increasing the setting of Pn485 will increase the Servomotor movement range that is required for polarity detection.	-

Continued on next page.

Continued from previous page.

Alarm Number: Alarm Name	Possible Cause	Confirmation	Correction	Reference
A.C51: Overtravel Detected during Polarity Detection	The overtravel signal was detected during polarity detection.	Check the overtravel position.	Wire the overtravel signals. Execute polarity detection at a position where an overtravel signal would not be detected.	*1
A.C52: Polarity Detection Not Completed	The servo was turned ON when using an absolute linear encoder, Pn587 was set to n.□□□0 (Do not detect polarity), and the polarity had not been detected.	—	When using an absolute linear encoder, set Pn587 to n.□□□1 (Detect polarity)	—
A.C53: Out of Range of Motion for Polarity Detection	The travel distance exceeded the setting of Pn48E (Polarity Detection Range) in the middle of detection.	—	Increase the setting of Pn48E (Polarity Detection Range). Or, increase the setting of Pn481 (Polarity Detection Speed Loop Gain).	—
A.C54: Polarity Detection Failure 2	An external force was applied to the Servomotor.	—	Increase the setting of Pn495 (Polarity Detection Confirmation Force Reference). Increase the setting of Pn498 (Polarity Detection Allowable Error Range). Increasing the allowable error will also increase the motor temperature.	—
A.C80: Encoder Clear Error or Multiturn Limit Setting Error	A failure occurred in the encoder.	—	Turn the power supply to the SERVOPACK OFF and ON again. If an alarm still occurs, the Servomotor or linear encoder may be faulty. Replace the Servomotor or linear encoder.	—
	A failure occurred in the SERVOPACK.	—	Turn the power supply to the SERVOPACK OFF and ON again. If an alarm still occurs, the SERVOPACK may be faulty. Replace the SERVOPACK.	—

Continued on next page.

Continued from previous page.

Alarm Number: Alarm Name	Possible Cause	Confirmation	Correction	Reference
A.C90: Encoder Commu- nications Error	There is a faulty contact in the connector or the connector is not wired correctly for the encoder.	Check the condition of the encoder connector.	Reconnect the encoder connector and check the encoder wiring.	*1
	There is a cable disconnection or short-circuit in the encoder. Or, the cable impedance is outside the specified values.	Check the condition of the Encoder Cable.	Use the Encoder Cable within the specified specifications.	-
	One of the following has occurred: corrosion caused by improper temperature, humidity, or gas, a short-circuit caused by entry of water drops or cutting oil, or faulty contact in connector caused by vibration.	Check the operating environment.	Improve the operating environmental, and replace the cable. If the alarm still occurs, replace the SERVOPACK.	*1
	A malfunction was caused by noise.	-	Correct the wiring around the encoder by separating the Encoder Cable from the Servomotor Main Circuit Cable or by grounding the encoder.	*1
	A failure occurred in the SERVOPACK.	-	Connect the Servomotor to another SERVOPACK, and turn ON the control power supply. If no alarm occurs, the SERVOPACK may be faulty. Replace the SERVOPACK.	-
A.C91: Encoder Commu- nications Posi- tion Data Acceleration Rate Error	Noise entered on the signal lines because the Encoder Cable is bent or the sheath is damaged.	Check the condition of the Encoder Cable and connectors.	Check the Encoder Cable to see if it is installed correctly.	*1
	The Encoder Cable is bundled with a high-current line or installed near a high-current line.	Check the installation condition of the Encoder Cable.	Confirm that there is no surge voltage on the Encoder Cable.	-
	There is variation in the FG potential because of the influence of machines on the Servomotor side, such as a welder.	Check the installation condition of the Encoder Cable.	Properly ground the machine to separate it from the FG of the encoder.	-

Continued on next page.

Continued from previous page.

Alarm Number: Alarm Name	Possible Cause	Confirmation	Correction	Reference
A.C92: Encoder Commu- nications Timer Error	Noise entered on the signal line from the encoder.	–	Implement countermeasures against noise for the encoder wiring.	*1
	Excessive vibration or shock was applied to the encoder.	Check the operating conditions.	Reduce machine vibration. Correctly install the Servomotor or linear encoder.	–
	A failure occurred in the encoder.	–	Turn the power supply to the SERVOPACK OFF and ON again. If an alarm still occurs, the Servomotor or linear encoder may be faulty. Replace the Servomotor or linear encoder.	–
	A failure occurred in the SERVOPACK.	–	Turn the power supply to the SERVOPACK OFF and ON again. If an alarm still occurs, the SERVOPACK may be faulty. Replace the SERVOPACK.	–
A.CA0: Encoder Parame- ter Error	A failure occurred in the encoder.	–	Turn the power supply to the SERVOPACK OFF and ON again. If an alarm still occurs, the Servomotor or linear encoder may be faulty. Replace the Servomotor or linear encoder.	–
	A failure occurred in the SERVOPACK.	–	Turn the power supply to the SERVOPACK OFF and ON again. If an alarm still occurs, the SERVOPACK may be faulty. Replace the SERVOPACK.	–

Continued on next page.

4.2.3 Troubleshooting Alarms

Continued from previous page.

Alarm Number: Alarm Name	Possible Cause	Confirmation	Correction	Reference
A.Cb0: Encoder Echo- back Error	The encoder is wired incorrectly or there is faulty contact.	Check the wiring of the encoder.	Make sure that the encoder is correctly wired.	*1
	The specifications of the Encoder Cable are not correct and noise entered on it.	–	Use a shielded twisted-pair wire cable or a screened twisted-pair cable with conductors of at least 0.12 mm ² .	–
	The Encoder Cable is too long and noise entered on it.	–	<ul style="list-style-type: none"> Rotary Servomotors: The Encoder Cable wiring distance must be 50 m max. Linear Servomotors: The Encoder Cable wiring distance must be 20 m max. 	–
	There is variation in the FG potential because of the influence of machines on the Servomotor side, such as a welder.	Check the condition of the Encoder Cable and connectors.	Properly ground the machine to separate it from the FG of the encoder.	–
	Excessive vibration or shock was applied to the encoder.	Check the operating conditions.	Reduce machine vibration. Correctly install the Servomotor or linear encoder.	–
	A failure occurred in the encoder.	–	Turn the power supply to the SERVOPACK OFF and ON again. If an alarm still occurs, the Servomotor or linear encoder may be faulty. Replace the Servomotor or linear encoder.	–
	A failure occurred in the SERVOPACK.	–	Turn the power supply to the SERVOPACK OFF and ON again. If an alarm still occurs, the SERVOPACK may be faulty. Replace the SERVOPACK.	–
A.CC0: Multiturn Limit Disagreement	When using a Direct Drive Servomotor, the setting of Pn205 (Multiturn Limit) does not agree with the encoder.	Check the setting of Pn205.	Correct the setting of Pn205 (0 to 65,535).	*1
	The multiturn limit of the encoder is different from that of the SERVOPACK. Or, the multiturn limit of the SERVOPACK has been changed.	Check the setting of Pn205 in the SERVOPACK.	Change the setting if the alarm occurs.	*1
	A failure occurred in the SERVOPACK.	–	Turn the power supply to the SERVOPACK OFF and ON again. If an alarm still occurs, the SERVOPACK may be faulty. Replace the SERVOPACK.	–

Continued on next page.

Continued from previous page.

Alarm Number: Alarm Name	Possible Cause	Confirmation	Correction	Reference
A.CF1: Reception Failed Error in Feed- back Option Module Commu- nications	The cable between the Serial Converter Unit and SERVOPACK is not wired correctly or there is a faulty contact.	Check the wiring of the external encoder.	Correctly wire the cable between the Serial Converter Unit and SERVOPACK.	*1
	A specified cable is not being used between Serial Converter Unit and SERVOPACK.	Check the wiring specifications of the external encoder.	Use a specified cable.	-
	The cable between the Serial Converter Unit and SERVOPACK is too long.	Measure the length of the cable that connects the Serial Converter Unit.	The length of the cable between the Serial Converter Unit and SERVOPACK must be 20 m or less.	-
	The sheath on cable between the Serial Converter Unit and SERVOPACK is broken.	Check the cable that connects the Serial Converter Unit.	Replace the cable between the Serial Converter Unit and SERVOPACK.	-
A.CF2: Timer Stopped Error in Feed- back Option Module Commu- nications	Noise entered the cable between the Serial Converter Unit and SERVOPACK.	-	Correct the wiring around the Serial Converter Unit, e.g., separate I/O signal lines from the Main Circuit Cables or ground.	-
	A failure occurred in the Serial Converter Unit.	-	Replace the Serial Converter Unit.	-
	A failure occurred in the SERVOPACK.	-	Replace the SERVOPACK.	-
A.d00: Position Deviation Overflow (The setting of Pn520 (Position Deviation Overflow Alarm Level) was exceeded by the position deviation while the servo was ON.)	The Servomotor U, V, and W wiring is not correct.	Check the wiring of the Servomotor's Main Circuit Cables.	Make sure that there are no faulty contacts in the wiring for the Servomotor and encoder.	-
	The position command speed is too fast.	Reduce the position command speed and try operating the SERVOPACK.	Reduce the position reference speed or the reference acceleration rate, or reconsider the electronic gear ratio.	*1
	The acceleration of the position reference is too high.	Reduce the reference acceleration and try operating the SERVOPACK.	Reduce the acceleration of the position reference using a MECHATROLINK command. Or, smooth the position reference acceleration by selecting the position reference filter (ACCFIL) using a MECHATROLINK command.	-
	The setting of Pn520 (Position Deviation Overflow Alarm Level) is too low for the operating conditions.	Check Pn520 (Position Deviation Overflow Alarm Level) to see if it is set to an appropriate value.	Optimize the setting of Pn520.	*1
	A failure occurred in the SERVOPACK.	-	Turn the power supply to the SERVOPACK OFF and ON again. If an alarm still occurs, the SERVOPACK may be faulty. Replace the SERVOPACK.	-

Continued on next page.

Continued from previous page.

Alarm Number: Alarm Name	Possible Cause	Confirmation	Correction	Reference
A.d01: Position Deviation Overflow Alarm at Servo ON	The servo was turned ON after the position deviation exceeded the setting of Pn526 (Position Deviation Overflow Alarm Level at Servo ON) while the servo was OFF.	Check the position deviation while the servo is OFF.	Optimize the setting of Pn526 (Position Deviation Overflow Alarm Level at Servo ON).	*1
A.d02: Position Deviation Overflow Alarm for Speed Limit at Servo ON	If position deviation remains in the deviation counter, the setting of Pn529 or Pn584 (Speed Limit Level at Servo ON) limits the speed when the servo is turned ON. This alarm occurs if a position reference is input and the setting of Pn520 (Position Deviation Overflow Alarm Level) is exceeded.	–	Optimize the setting of Pn520 (Position Deviation Overflow Alarm Level). Or, adjust the setting of Pn529 or Pn584 (Speed Limit Level at Servo ON).	*1
A.d10: Motor-Load Position Deviation Overflow	The motor direction and external encoder installation orientation are backward.	Check the motor direction and the external encoder installation orientation.	Install the external encoder in the opposite direction, or change the setting of Pn002 = n.X□□□ (External Encoder Usage) to reverse the direction.	*1
	There is an error in the connection between the load (e.g., stage) and external encoder coupling.	Check the coupling of the external encoder.	Check the mechanical coupling.	–
A.d30: Position Data Overflow	The position data exceeded ±1,879,048,192.	Check the input reference pulse counter.	Reconsider the operating specifications.	–
A.E02: MECHATROLINK Internal Synchronization Error 1	The MECHATROLINK transmission cycle fluctuated.	–	Remove the cause of transmission cycle fluctuation at the host controller.	–
	A failure occurred in the SERVOPACK.	–	Turn the power supply to the SERVOPACK OFF and ON again. If an alarm still occurs, the SERVOPACK may be faulty. Replace the SERVOPACK.	–
A.E40: MECHATROLINK Transmission Cycle Setting Error	The setting of MECHATROLINK transmission cycle is outside of the specified range.	Check the setting of the MECHATROLINK transmission cycle.	Set the MECHATROLINK transmission cycle to an appropriate value.	–
A.E41: MECHATROLINK Communications Data Size Setting Error	The number of transmission bytes set on DIP switch S3 is not correct.	Check the MECHATROLINK communications data size of the host controller.	Reset DIP switch S3 to change the number of transmission bytes to an appropriate value.	*1

Continued on next page.

Continued from previous page.

Alarm Number: Alarm Name	Possible Cause	Confirmation	Correction	Reference
A.E42: MECHATROLINK Station Address Setting Error	The station address is outside of the setting range.	Check rotary switches S1 and S2 to see if the station address is between 03 and EF.	Check the setting of the station address of the host controller, and reset rotary switches S1 and S2 to change the address to an appropriate value between 03 and EF.	*1
	Two or more stations on the communications network have the same address.	Check to see if two or more stations on the communications network have the same address.	Check the setting of the station address of the host controller, and reset rotary switches S1 and S2 to change the address to an appropriate value between 03 and EF.	*1
A.E50*4: MECHATROLINK Synchronization Error	The WDT data in the host controller was not updated normally.	Check to see if the WDT data is being updated at the host controller.	Correctly update the WDT data at the host controller.	-
	A failure occurred in the SERVOPACK.	-	Turn the power supply to the SERVOPACK OFF and ON again. If an alarm still occurs, the SERVOPACK may be faulty. Replace the SERVOPACK.	-
A.E51: MECHATROLINK Synchronization Failed	The WDT data at the host controller was not updated correctly at the start of synchronous communications, so synchronous communications could not be started.	Check to see if the WDT data is being updated in the host controller.	Correctly update the WDT data at the host controller.	-
	A failure occurred in the SERVOPACK.	-	Turn the power supply to the SERVOPACK OFF and ON again. If an alarm still occurs, the SERVOPACK may be faulty. Replace the SERVOPACK.	-
A.E60*4: Reception Error in MECHATROLINK Communications	MECHATROLINK wiring is not correct.	Check the MECHATROLINK wiring.	Correct the MECHATROLINK Communications Cable wiring. Correctly connect the terminator.	-
	A MECHATROLINK data reception error occurred due to noise.	-	Implement countermeasures against noise. (Check the MECHATROLINK Communications Cable and FG wiring, and implement measures such as attaching a ferrite core to the MECHATROLINK Communications Cable.)	-
	A failure occurred in the SERVOPACK.	-	Turn the power supply to the SERVOPACK OFF and ON again. If an alarm still occurs, the SERVOPACK may be faulty. Replace the SERVOPACK.	-

Continued on next page.

Continued from previous page.

Alarm Number: Alarm Name	Possible Cause	Confirmation	Correction	Reference
A.E61: Synchronization Interval Error in MECHATROLINK Transmission Cycle	The MECHATROLINK transmission cycle fluctuated.	Check the setting of the MECHATROLINK transmission cycle.	Remove the cause of transmission cycle fluctuation at the host controller.	-
	A failure occurred in the SERVOPACK.	-	Turn the power supply to the SERVOPACK OFF and ON again. If an alarm still occurs, the SERVOPACK may be faulty. Replace the SERVOPACK.	-
A.E63: MECHATROLINK Synchronization Frame Not Received	MECHATROLINK wiring is not correct.	Check the Servomotor wiring.	Correct the MECHATROLINK Communications Cable wiring.	-
	A MECHATROLINK data reception error occurred due to noise.	-	Implement countermeasures against noise. (Check the MECHATROLINK Communications Cable and FG wiring, and implement measures such as attaching a ferrite core to the MECHATROLINK Communications Cable.)	-
	A failure occurred in the SERVOPACK.	-	Turn the power supply to the SERVOPACK OFF and ON again. If an alarm still occurs, the SERVOPACK may be faulty. Replace the SERVOPACK.	-
A.E71: Safety Option Module Detection Failure	There is a faulty connection between the SERVOPACK and the Safety Option Module.	Check the connection between the SERVOPACK and the Safety Option Module.	Correctly connect the Safety Option Module.	-
	The Safety Option Module was disconnected.	-	Execute Fn014 (Reset Option Module Configuration Error) from the Digital Operator or SigmaWin+ and then turn the power supply to the SERVOPACK OFF and ON again.	*1
	A failure occurred in the Safety Option Module.	-	Replace the Safety Option Module.	-
	A failure occurred in the SERVOPACK.	-	Replace the SERVOPACK.	-
A.E72: Feedback Option Module Detection Failure	There is a faulty connection between the SERVOPACK and the Feedback Option Module.	Check the connection between the SERVOPACK and the Feedback Option Module.	Correctly connect the Feedback Option Module.	-
	The Feedback Option Module was disconnected.	-	Reset the Option Module configuration error and turn the power supply to the SERVOPACK OFF and ON again.	*1
	A failure occurred in the Feedback Option Module.	-	Replace the Feedback Option Module.	-
	A failure occurred in the SERVOPACK.	-	Replace the SERVOPACK.	-

Continued on next page.

Continued from previous page.

Alarm Number: Alarm Name	Possible Cause	Confirmation	Correction	Reference
A.E74: Unsupported Safety Option Module	A failure occurred in the Safety Option Module.	–	Replace the Safety Option Module.	–
	An unsupported Safety Option Module was connected.	Refer to the catalog of the connected Safety Option Module.	Connect a compatible Safety Option Module.	–
A.Eb1: Safety Function Signal Input Tim- ing Error	The delay between activation of the /HWBB1 and /HWBB2 input signals for the HWBB was ten second or longer.	Measure the time delay between the /HWBB1 and /HWBB2 signals.	The output signal circuits or devices for /HWBB1 and /HWBB2 or the SERVOPACK input signal circuits may be faulty. Alternatively, the input signal cables may be disconnected. Check to see if any of these items are faulty or have been disconnected.	–
	A failure occurred in the SERVOPACK.	–	Replace the SERVOPACK.	–
A.EC8: Gate Drive Error 1 (An error occurred in the gate drive circuit.)	A failure occurred in the SERVOPACK.	–	Turn the power supply to the SERVOPACK OFF and ON again. If an alarm still occurs, the SERVOPACK may be faulty. Replace the SERVOPACK.	–
A.EC9: Gate Drive Error 2 (An error occurred in the gate drive circuit.)				
A.Ed1: Command Exe- cution Timeout	A timeout error occurred for a MECHATROLINK command.	Check the motor status when the command is executed.	Execute the SV_ON or SENS_ON command only when the motor is not operating.	–
		<ul style="list-style-type: none"> For fully-closed loop control, check the status of the external encoder when the command is executed. For other types of control, check the status of the linear encoder when the command is executed. 	Execute the SENS_ON command only when an external encoder (e.g., a linear encoder) is connected.	–

Continued on next page.

Continued from previous page.

Alarm Number: Alarm Name	Possible Cause	Confirmation	Correction	Reference
A.F10: Power Supply Line Open Phase (The voltage was low for more than one second for phase R, S, or T when the main power supply was ON.)	The three-phase power supply wiring is not correct.	Check the power supply wiring.	Make sure that the power supply is correctly wired.	*1
	The three-phase power supply is unbalanced.	Measure the voltage for each phase of the three-phase power supply.	Balance the power supply by changing phases.	-
	A single-phase power supply was input without specifying a signal-phase AC power supply input (Pn00B = n.□1□□).	Check the power supply and the parameter setting.	Match the parameter setting to the power supply.	*1
	A failure occurred in the SERVOPACK.	-	Turn the power supply to the SERVOPACK OFF and ON again. If an alarm still occurs, the SERVOPACK may be faulty. Replace the SERVOPACK.	-
A.F50: Servomotor Main Circuit Cable Disconnection (The Servomotor did not operate or power was not supplied to the Servomotor even though the SV_ON (Servo ON) command was input when the Servomotor was ready to receive it.)	A failure occurred in the SERVOPACK.	-	The SERVOPACK may be faulty. Replace the SERVOPACK.	-
	The wiring is not correct or there is a faulty contact in the motor wiring.	Check the wiring.	Make sure that the Servomotor is correctly wired.	*1
FL-1*3: System Alarm	A failure occurred in the SERVOPACK.	-	Turn the power supply to the SERVOPACK OFF and ON again. If an alarm still occurs, the SERVOPACK may be faulty. Replace the SERVOPACK.	-
FL-2*3: System Alarm				
FL-3*3: System Alarm				
FL-4*3: System Alarm				
FL-5*3: System Alarm				
CPF00: Digital Operator Communications Error 1	There is a faulty contact between the Digital Operator and the SERVOPACK.	Check the connector contact.	Disconnect the connector and insert it again. Or, replace the cable.	-
	A malfunction was caused by noise.	-	Keep the Digital Operator or the cable away from sources of noise.	-

Continued on next page.

Continued from previous page.

Alarm Number: Alarm Name	Possible Cause	Confirmation	Correction	Reference
CPF01: Digital Operator Communications Error 2	A failure occurred in the Digital Operator.	—	Disconnect the Digital Operator and then connect it again. If an alarm still occurs, the Digital Operator may be faulty. Replace the Digital Operator.	—
	A failure occurred in the SERVOPACK.	—	Turn the power supply to the SERVOPACK OFF and ON again. If an alarm still occurs, the SERVOPACK may be faulty. Replace the SERVOPACK.	—

*1. Refer to the following manual for details.

 Σ -7-Series Σ -7S SERVOPACK with MECHATROLINK-III Communications References Product Manual (Manual No.: SIEP S800001 28)

*2. Detection Conditions

• Rotary Servomotor

If either of the following conditions is detected, an alarm will occur.

$$\bullet \text{ Pn533 [min}^{-1}\text{]} \times \frac{\text{Encoder resolution}}{6 \times 10^5} \leq \frac{\text{Pn20E}}{\text{Pn210}}$$

$$\bullet \text{ Maximum motor speed [min}^{-1}\text{]} \times \frac{\text{Encoder resolution}}{\text{Approx. } 3.66 \times 10^{12}} \geq \frac{\text{Pn20E}}{\text{Pn210}}$$

• Linear Servomotor

If either of the following conditions is detected, an alarm will occur.

$$\bullet \frac{\text{Pn585 [mm/s]}}{\text{Linear encoder pitch [\mu m]}} \times \frac{\text{Resolution of Serial Converter Unit}}{10} \leq \frac{\text{Pn20E}}{\text{Pn210}}$$

$$\bullet \frac{\text{Pn385 [100 mm/s]}}{\text{Linear encoder pitch [\mu m]}} \times \frac{\text{Resolution of Serial Converter Unit}}{\text{Approx. } 6.10 \times 10^5} \geq \frac{\text{Pn20E}}{\text{Pn210}}$$

*3. Detection Conditions

• Rotary Servomotor

If either of the following conditions is detected, an alarm will occur.

$$\bullet \text{ Rated motor speed [min}^{-1}\text{]} \times 1/3 \times \frac{\text{Encoder resolution}}{6 \times 10^5} \leq \frac{\text{Pn20E}}{\text{Pn210}}$$

$$\bullet \text{ Maximum motor speed [min}^{-1}\text{]} \times \frac{\text{Encoder resolution}}{\text{Approx. } 3.66 \times 10^{12}} \geq \frac{\text{Pn20E}}{\text{Pn210}}$$

• Linear Servomotor

If either of the following conditions is detected, an alarm will occur.

$$\bullet \frac{\text{Rated motor speed [mm/s]} \times 1/3}{\text{Linear encoder pitch [\mu m]}} \times \frac{\text{Resolution of Serial Converter Unit}}{10} \leq \frac{\text{Pn20E}}{\text{Pn210}}$$

$$\bullet \frac{\text{Pn385 [100 mm/s]}}{\text{Linear encoder pitch [\mu m]}} \times \frac{\text{Resolution of Serial Converter Unit}}{\text{Approx. } 6.10 \times 10^5} \geq \frac{\text{Pn20E}}{\text{Pn210}}$$

*4. Refer to the following manual for details.

 Σ -7-Series Peripheral Device Selection Manual (Manual No.: SIEP S800001 32)

*5. These alarms are not stored in the alarm history. They are only displayed on the panel display.

4.2.4 Warning Displays

If a warning occurs in the SERVOPACK, a warning number will be displayed on the panel display. Warnings are displayed to warn you before an alarm occurs.

4.2.5 List of Warnings

The list of warnings gives the warning name and warning meaning in order of the warning numbers.

Warning Number	Warning Name	Meaning	Resetting
A.900	Position Deviation Overflow	The position deviation exceeded the parameter settings (Pn520 × Pn51E/100).	Required.
A.901	Position Deviation Overflow Alarm at Servo ON	The position deviation exceeded the parameter settings (Pn526 × Pn528/100) when the servo was turned ON.	Required.
A.910	Overload	This warning occurs before an overload alarm (A.710 or A.720) occurs. If the warning is ignored and operation is continued, an alarm may occur.	Required.
A.911	Vibration	Abnormal vibration was detected during motor operation. The detection level is the same as A.520. Set whether to output an alarm or a warning by setting Pn310 (Vibration Detection Selections).	Required.
A.912	Internal Temperature Warning 1 (Control Board Temperature Error)	The surrounding temperature of the control PCB is abnormal.	Required.
A.913	Internal Temperature Warning 2 (Power Board Temperature Error)	The surrounding temperature of the power PCB is abnormal.	Required.
A.920	Regenerative Overload	This warning occurs before an A.320 alarm (Regenerative Overload) occurs. If the warning is ignored and operation is continued, an alarm may occur.	Required.
A.921	Dynamic Brake Overload	This warning occurs before an A.731 alarm (Dynamic Brake Overload) occurs. If the warning is ignored and operation is continued, an alarm may occur.	Required.
A.923	SERVOPACK Built-in Fan Stopped	The fan inside the SERVOPACK stopped.	Required.
A.930	Absolute Encoder Battery Error	This warning occurs when the voltage of absolute encoder's battery is low.	Required.
A.942	Speed Ripple Compensation Information Disagreement	The speed ripple compensation information stored in the encoder does not agree with the speed ripple compensation information stored in the SERVOPACK.	Required.
A.94A	Data Setting Warning 1 (Parameter Number Error)	There is an error in the parameter number for a Data Setting Warning 1 (Parameter Number) command.	Automatically reset.*
A.94b	Data Setting Warning 2 (Out of Range)	The command data is out of range.	Automatically reset.*
A.94C	Data Setting Warning 3 (Calculation Error)	A calculation error was detected.	Automatically reset.*
A.94d	Data Setting Warning 4 (Parameter Size)	The data sizes do not match.	Automatically reset.*
A.94E	Data Setting Warning 5 (Latch Mode Error)	A latch mode error was detected.	Required.
A.95A	Command Warning 1 (Unsatisfied Command Conditions)	A command was sent when the conditions for sending a command were not satisfied.	Automatically reset.*
A.95b	Command Warning 2 (Unsupported Command)	An unsupported command was sent.	Automatically reset.*

Continued on next page.

Continued from previous page.

Warning Number	Warning Name	Meaning	Resetting
A.95d	Command Warning 4 (Command Interference)	There was command interference, particularly latch command interference.	Automatically reset.*
A.95E	Command Warning 5 (Subcommand Not Possible)	The subcommand and main command interfere with each other.	Automatically reset.*
A.95F	Command Warning 6 (Undefined Command)	An undefined command was sent.	Automatically reset.*
A.960	MECHATROLINK Communications Warning	A communications error occurred during MECHATROLINK communications.	Required.
A.971	Undervoltage	This warning occurs before an A.410 alarm (Undervoltage) occurs. If the warning is ignored and operation is continued, an alarm may occur.	Required.
A.97A	Command Warning 7 (Phase Error)	A command that cannot be executed in the current phase was sent.	Automatically reset.*
A.97b	Data Clamp Out of Range	The set command data was clamped to the minimum or maximum value of the allowable setting range.	Automatically reset.*
A.9A0	Overtravel	Overtravel was detected while the servo was ON.	Required.
A.9b0	Preventative Maintenance Warning	One of the consumable parts has reached the end of its service life.	Required.

* If using the commands for the MECHATROLINK-III standard servo profile, the warning will automatically be cleared after the correct command is received. If you use MECHATROLINK-II-compatible profile commands, send an ALM_CLR (Clear Warning or Alarm) command to clear the warning.

Note: 1. A warning code is not output unless you set Pn001 to n.1□□□ (Output both alarm codes and warning codes).

2. Use Pn008 = n.□X□□ (Warning Detection Selection) to control warning detection. However, the following warnings are not affected by the setting of Pn008 = n.□X□□ and other parameter settings are required in addition to Pn008 = n.□X□□.

Warning	Parameters That Must Be Set to Select Warning Detection
A.911	Pn310 = n.□□□X (Vibration Detection Selection)
A.923	– (Not affected by the setting of Pn008 = n.□X□□.)
A.930	Pn008 = n.□□□X (Low Battery Voltage Alarm/Warning Selection)
A.942	Pn423 = n.□□X□ (Speed Ripple Compensation Information Disagreement Warning Detection Selection)
A.94A to A.960 and A.97A to A.97b	Pn800=n.□□X□ (Warning Check Masks)
A.971	Pn008 = n.□□□X (Low Battery Voltage Alarm/Warning Selection) (Not affected by the setting of Pn008 = n.□X□□.)
A.9A0	Pn00D = n.X□□□ (Overtravel Warning Detection Selection) (Not affected by the setting of Pn008 = n.□X□□.)
A.9b0	Pn00F = n.□□□X (Preventative Maintenance Warning Selection)

4.2.6 Troubleshooting Warnings

The causes of and corrections for the warnings are given in the following table. Contact your Yaskawa representative if you cannot solve a problem with the correction given in the table.

Warning Number: Warning Name	Possible Cause	Confirmation	Correction	Reference
A.900: Position Deviation Overflow	The Servomotor U, V, and W wiring is not correct.	Check the wiring of the Servomotor's Main Circuit Cables.	Make sure that there are no faulty connections in the wiring for the Servomotor and encoder.	–
	A SERVOPACK gain is too low.	Check the SERVO-PACK gains.	Increase the servo gain, e.g., by using autotuning without a host reference.	*
	The acceleration of the position reference is too high.	Reduce the reference acceleration and try operating the SERVO-PACK.	Reduce the acceleration of the position reference using a MECHATROLINK command. Or, smooth the position reference acceleration by selecting the position reference filter (ACCFIL) using a MECHATROLINK command.	–
	The excessive position deviation alarm level (Pn520 × Pn51E/100) is too low for the operating conditions.	Check excessive position deviation alarm level (Pn520 × Pn51E/100) to see if it is set to an appropriate value.	Optimize the settings of Pn520 and Pn51E.	*
	A failure occurred in the SERVO-PACK.	–	Turn the power supply to the SERVOPACK OFF and ON again. If an alarm still occurs, the SERVOPACK may be faulty. Replace the SERVOPACK.	–
A.901: Position Deviation Overflow Alarm at Servo ON	The position deviation exceeded the parameter settings (Pn526 × Pn528/100) when the servo was turned ON.	–	Optimize the setting of Pn528 (Position Deviation Overflow Warning Level at Servo ON).	–

Continued on next page.

Continued from previous page.

Warning Number: Warning Name	Possible Cause	Confirmation	Correction	Reference
A.910: Overload (warning before an A.710 or A.720 alarm occurs)	The wiring is not correct or there is a faulty contact in the motor or encoder wiring.	Check the wiring.	Make sure that the Servomotor and encoder are correctly wired.	–
	Operation was performed that exceeded the overload protection characteristics.	Check the motor overload characteristics and Run command.	Reconsider the load and operating conditions. Or, increase the motor capacity.	–
	An excessive load was applied during operation because the Servomotor was not driven because of mechanical problems.	Check the operation reference and motor speed.	Remove the mechanical problem.	–
	The overload warning level (Pn52B) is not suitable.	Check that the overload warning level (Pn52B) is suitable.	Set a suitable overload warning level (Pn52B).	*
	A failure occurred in the SERVOPACK.	–	The SERVOPACK may be faulty. Replace the SERVOPACK.	–
A.911: Vibration	Abnormal vibration was detected during motor operation.	Check for abnormal motor noise, and check the speed and torque waveforms during operation.	Reduce the motor speed. Or, reduce the servo gain with custom tuning.	*
	The setting of Pn103 (Moment of Inertia Ratio) is greater than the actual moment of inertia or was greatly changed.	Check the moment of inertia ratio or mass ratio.	Set Pn103 (Moment of Inertia Ratio) to an appropriate value.	*
	The vibration detection level (Pn312 or Pn384) is not suitable.	Check that the vibration detection level (Pn312 or Pn384) is suitable.	Set a suitable vibration detection level (Pn312 or Pn384).	*

Continued on next page.

Continued from previous page.

Warning Number: Warning Name	Possible Cause	Confirmation	Correction	Reference
A.912: Internal Temperature Warning 1 (Control Board Temperature Error)	The surrounding temperature is too high.	Check the surrounding temperature using a thermostat. Or, check the operating status with the SERVOPACK installation environment monitor.	Decrease the surrounding temperature by improving the SERVOPACK installation conditions.	*
	An overload alarm was reset by turning OFF the power supply too many times.	Check the alarm display to see if there is an overload alarm.	Change the method for resetting the alarm.	-
	There was an excessive load or operation was performed that exceeded the regenerative processing capacity.	Use the accumulated load ratio to check the load during operation, and use the regenerative load ratio to check the regenerative processing capacity.	Reconsider the load and operating conditions.	-
	The SERVOPACK installation orientation is not correct or there is insufficient space around the SERVOPACK.	Check the SERVOPACK installation conditions.	Install the SERVOPACK according to specifications.	*
	A failure occurred in the SERVOPACK.	-	The SERVOPACK may be faulty. Replace the SERVOPACK.	-
A.913: Internal Temperature Warning 2 (Power Board Temperature Error)	The surrounding temperature is too high.	Check the surrounding temperature using a thermostat. Or, check the operating status with the SERVOPACK installation environment monitor.	Decrease the surrounding temperature by improving the SERVOPACK installation conditions.	*
	An overload alarm was reset by turning OFF the power supply too many times.	Check the alarm display to see if there is an overload alarm.	Change the method for resetting the alarm.	-
	There was an excessive load or operation was performed that exceeded the regenerative processing capacity.	Use the accumulated load ratio to check the load during operation, and use the regenerative load ratio to check the regenerative processing capacity.	Reconsider the load and operating conditions.	-
	The SERVOPACK installation orientation is not correct or there is insufficient space around the SERVOPACK.	Check the SERVOPACK installation conditions.	Install the SERVOPACK according to specifications.	*
	A failure occurred in the SERVOPACK.	-	The SERVOPACK may be faulty. Replace the SERVOPACK.	-

Continued on next page.

Continued from previous page.

Warning Number: Warning Name	Possible Cause	Confirmation	Correction	Reference
A.920: Regenerative Overload (warning before an A.320 alarm occurs)	The power supply voltage exceeded the specified range.	Measure the power supply voltage.	Set the power supply voltage within the specified range.	–
	There is insufficient external regenerative resistance, regenerative resistor capacity, or SERVOPACK capacity, or there has been a continuous regeneration state.	Check the operating conditions or the capacity using the SigmaJunmaSize+ Capacity Selection Software or another means.	Change the regenerative resistance value, regenerative resistance capacity, or SERVOPACK capacity. Reconsider the operating conditions using the SigmaJunmaSize+ Capacity Selection Software or other means.	–
	There was a continuous regeneration state because a negative load was continuously applied.	Check the load applied to the Servomotor during operation.	Reconsider the system including the servo, machine, and operating conditions.	–
A.921: Dynamic Brake Overload (warning before an A.731 alarm occurs)	The Servomotor was rotated by an external force.	Check the operation status.	Implement measures to ensure that the motor will not be rotated by an external force.	–
	When the Servomotor was stopped with the dynamic brake, the rotational or linear kinetic energy exceeded the capacity of the dynamic brake resistor.	Check the power consumed by the DB resistor to see how frequently the DB is being used.	Reconsider the following: <ul style="list-style-type: none"> • Reduce the Servomotor command speed. • Decrease the moment of inertia or mass. • Reduce the frequency of stopping with the dynamic brake. 	–
	A failure occurred in the SERVOPACK.	–	The SERVOPACK may be faulty. Replace the SERVOPACK.	–
A.923: SERVOPACK Built-in Fan Stopped	The fan inside the SERVOPACK stopped.	Check for foreign matter inside the SERVOPACK.	Remove foreign matter from the SERVOPACK. If an alarm still occurs, the SERVOPACK may be faulty. Replace the SERVOPACK.	–
A.930: Absolute Encoder Battery Error (The absolute encoder battery voltage was lower than the specified level.) (Detected only when an absolute encoder is connected.)	The battery connection is faulty or a battery is not connected.	Check the battery connection.	Correct the battery connection.	*
	The battery voltage is lower than the specified value (2.7 V).	Measure the battery voltage.	Replace the battery.	*
	A failure occurred in the SERVOPACK.	–	The SERVOPACK may be faulty. Replace the SERVOPACK.	–

Continued on next page.

Continued from previous page.

Warning Number: Warning Name	Possible Cause	Confirmation	Correction	Reference
A.942: Speed Ripple Compensation Information Disagreement	The speed ripple compensation information stored in the encoder does not agree with the speed ripple compensation information stored in the SERVOPACK.	–	Reset the speed ripple compensation value on the SigmaWin+.	*
		–	Set Pn423 to n.□□1□ (Do not detect A.942 alarms). However, changing the setting may increase the speed ripple.	*
		–	Set Pn423 to n.□□□0 (Disable speed ripple compensation). However, changing the setting may increase the speed ripple.	*
A.94A: Data Setting Warning 1 (Parameter Number Error)	An invalid parameter number was used.	Check the command that caused the warning.	Use the correct parameter number.	*
A.94b: Data Setting Warning 2 (Out of Range)	The set command data was clamped to the minimum or maximum value of the setting range.	Check the command that caused the warning.	Set the parameter within the setting range.	*
A.94C: Data Setting Warning 3 (Calculation Error)	The calculation result of the setting is not correct.	Check the command that caused the warning.	Set the parameter within the setting range.	*
A.94d: Data Setting Warning 4 (Parameter Size)	The parameter size set in the command is not correct.	Check the command that caused the warning.	Set the correct parameter size.	*
A.94E: Data Setting Warning 5 (Latch Mode Error)	A latch mode error was detected.	Check the command that caused the warning.	Change the setting of Pn850 or the LT_MOD data for the LTMOD_ON command sent by the host controller to an appropriate value. (The applies when using the MECHATROLINK-II-compatible profile.)	*
A.95A: Command Warning 1 (Unsatisfied Command Conditions)	The command conditions are not satisfied.	Check the command that caused the warning.	Send the command after the command conditions are satisfied.	*
A.95b: Command Warning 2 (Unsupported Command)	An unsupported command was received.	Check the command that caused the warning.	Do not send unsupported commands.	*
A.95d: Command Warning 4 (Command Interference)	The command sending conditions for latch-related commands was not satisfied.	Check the command that caused the warning.	Send the command after the command conditions are satisfied.	*
A.95E: Command Warning 5 (Subcommand Not Possible)	The command sending conditions for subcommands was not satisfied.	Check the command that caused the warning.	Send the command after the conditions are satisfied.	*

Continued on next page.

Continued from previous page.

Warning Number: Warning Name	Possible Cause	Confirmation	Correction	Reference
A.95F: Command Warning 6 (Undefined Com- mand)	An undefined command was sent.	Check the command that caused the warn- ing.	Do not send undefined commands.	*
A.960: MECHATROLINK Communications Warning	The MECHA- TROLINK Com- munications Cable is not wired cor- rectly.	Check the wiring con- ditions.	Correct the MECHA- TROLINK communications cable wiring.	*
	A MECHA- TROLINK data reception error occurred due to noise.	Confirm the installation conditions.	Implement the following countermeasures against noise. • Check the MECHA- TROLINK Communica- tions Cable and FG wiring and implement counter- measures to prevent noise from entering. • Attach a ferrite core to the MECHATROLINK Com- munications Cable.	–
	A failure occurred in the SERVO- PACK.	–	The SERVOPACK may be faulty. Replace the SERVO- PACK.	–
A.971: Undervoltage	For a 200-V SER- VOPACK, the AC power supply volt- age dropped below 140 V.	Measure the power supply voltage.	Set the power supply volt- age within the specified range.	–
	The power supply voltage dropped during operation.	Measure the power supply voltage.	Increase the power supply capacity.	–
	A momentary power interrup- tion occurred.	Measure the power supply voltage.	If you have changed the setting of Pn509 (Momen- tary Power Interruption Hold Time), decrease the setting.	*
	The SERVOPACK fuse is blown out.	–	Replace the SERVOPACK and connect a reactor.	*
	A failure occurred in the SERVO- PACK.	–	The SERVOPACK may be faulty. Replace the SERVO- PACK.	–
A.97A: Command Warning 7 (Phase Error)	A command that cannot be exe- cuted in the cur- rent phase was sent.	–	Send the command after the command conditions are satisfied.	–
A.97b: Data Clamp Out of Range	The set com- mand data was clamped to the minimum or maxi- mum value of the setting range.	–	Set the command data within the setting ranges.	–

Continued on next page.

Continued from previous page.

Warning Number: Warning Name	Possible Cause	Confirmation	Correction	Reference
A.9A0: Overtravel (Overtravel status was detected.)	Overtravel was detected while the servo was ON.	Check the status of the overtravel signals on the input signal monitor.	Even if an overtravel signal is not shown by the input signal monitor, momentary overtravel may have been detected. Take the following precautions. <ul style="list-style-type: none"> • Do not specify movements that would cause overtravel from the host controller. • Check the wiring of the overtravel signals. • Implement countermeasures against noise. 	*
A.9b0: Preventative Maintenance Warning	One of the consumable parts has reached the end of its service life.	-	Replace the part. Contact your Yaskawa representative for replacement.	*

* Refer to the following manual for details.

 Σ-7-Series Σ-7S SERVOPACK with MECHATROLINK-III Communications References Product Manual (Manual No.: SIEP S800001 28)

4.2.7 Troubleshooting Based on the Operation and Conditions of the Servomotor

This section provides troubleshooting based on the operation and conditions of the Servomotor, including causes and corrections.

Turn OFF the Servo System before troubleshooting the items shown in bold lines in the table.

Problem	Possible Cause	Confirmation	Correction	Reference
Servomotor Does Not Start	The control power supply is not turned ON.	Measure the voltage between control power supply terminals.	Correct the wiring so that the control power supply is turned ON.	-
	The main circuit power supply is not turned ON.	Measure the voltage across the main circuit power input terminals.	Correct the wiring so that the main circuit power supply is turned ON.	-
	The I/O signal connector (CN1) pins are not wired correctly or are disconnected.	Check the wiring condition of the I/O signal connector (CN1) pins.	Correct the wiring of the I/O signal connector (CN1) pins.	*
	The wiring for the Servomotor Main Circuit Cables or Encoder Cable is disconnected.	Check the wiring conditions.	Wire the cable correctly.	-
	There is an overload on the Servomotor.	Operate the Servomotor with no load and check the load status.	Reduce the load or replace the Servomotor with a Servomotor with a larger capacity.	-
	The type of encoder that is being used does not agree with the setting of Pn002 = n.□X□□ (Encoder Usage).	Check the type of the encoder that is being used and the setting of Pn002 = n.□X□□.	Set Pn002 = n.□X□□ according to the type of the encoder that is being used.	*
	There is a mistake in the input signal allocations (Pn50A, Pn50B, Pn511, and Pn516).	Check the input signal allocations (Pn50A, Pn50B, Pn511, and Pn516).	Correctly allocate the input signals (Pn50A, Pn50B, Pn511, and Pn516).	*
	The SV_ON command was not sent.	Check the commands sent from the host controller.	Send the SV_ON command from the host controller.	-
	The SENS_ON (Turn ON Sensor) command was not sent.	Check the commands sent from the host controller.	Send the commands to the SERVOPACK in the correct sequence.	-
	The P-OT (Forward Drive Prohibit) or N-OT (Reverse Drive Prohibit) signal is still OFF.	Check the P-OT and N-OT signals.	Turn ON the P-OT and N-OT signals.	*
The safety input signals (/HWBB1 or /HWBB2) were not turned ON.	Check the /HWBB1 and /HWBB2 input signals.	Turn ON the /HWBB1 and /HWBB2 input signals. If you are not using the safety function, connect the Safety Jumper Connector (provided as an accessory) to CN8.	*	
The FSTP (Forced Stop Input) signal is still OFF.	Check the FSTP signal.	<ul style="list-style-type: none"> Turn ON the FSTP signal. If you will not use the function to force the motor to stop, set Pn516 = n.□□□X (FSTP (Forced Stop Input) Signal Allocation) to disable the signal. 	*	

Continued on next page.

4.2.7 Troubleshooting Based on the Operation and Conditions of the Servomotor

Continued from previous page.

Problem	Possible Cause	Confirmation	Correction	Reference
Servomotor Does Not Start	A failure occurred in the SERVOPACK.	–	Replace the SERVOPACK.	–
	The polarity detection was not executed.	Check the setting of Pn080 = n.□□□X (Polarity Sensor Selection).	Correct the parameter setting.	*
		Check the inputs to the SV_ON (Servo ON) command.	<ul style="list-style-type: none"> If you are using an incremental linear encoder, send the SV_ON command from the host controller. If you are using an absolute linear encoder, execute polarity detection. 	*
Servomotor Moves Instantaneously, and Then Stops	There is a mistake in the Servomotor wiring.	Check the wiring.	Wire the Servomotor correctly.	–
	There is a mistake in the wiring of the encoder or Serial Converter Unit.	Check the wiring.	Wire the Serial Converter Unit correctly.	–
	There is a mistake in the linear encoder wiring.	Check the wiring.	Wire the cable correctly.	–
	The setting of Pn282 (Linear Encoder Scale Pitch) is not correct.	Check the setting of Pn282.	Correct the setting of Pn282.	*
	The count-up direction of the linear encoder does not match the forward direction of the Moving Coil in the motor.	Check the directions.	Change the setting of Pn080 = n.□□X□ (Motor Phase Sequence Selection). Place the linear encoder and motor in the same direction.	*
	Polarity detection was not performed correctly.	Check to see if electrical angle 2 (electrical angle from polarity origin) at any position is between $\pm 10^\circ$.	Correct the settings for the polarity detection-related parameters.	–
Servomotor Speed Is Unstable	There is a faulty connection in the Servomotor wiring.	The connector connections for the power line (U, V, and W phases) and the encoder or Serial Converter Unit may be unstable. Check the wiring.	Tighten any loose terminals or connectors and correct the wiring.	–
Servomotor Moves without a Reference Input	A failure occurred in the SERVOPACK.	–	Replace the SERVOPACK.	–
	The count-up direction of the linear encoder does not match the forward direction of the Moving Coil in the motor.	Check the directions.	Change the setting of Pn080 = n.□□X□ (Motor Phase Sequence Selection). Match the linear encoder direction and Servomotor direction.	*
	Polarity detection was not performed correctly.	Check to see if electrical angle 2 (electrical angle from polarity origin) at any position is between $\pm 10^\circ$.	Correct the settings for the polarity detection-related parameters.	–

Continued on next page.

4.2.7 Troubleshooting Based on the Operation and Conditions of the Servomotor

Continued from previous page.

Problem	Possible Cause	Confirmation	Correction	Reference
Dynamic Brake Does Not Operate	The setting of Pn001 = n.□□□X (Motor Stopping Method for Servo OFF and Group 1 Alarms) is not suitable.	Check the setting of Pn001 = n.□□□X.	Set Pn001 = n.□□□X correctly.	-
	The dynamic brake resistor is disconnected.	Check the moment of inertia, motor speed, and dynamic brake frequency of use. If the moment of inertia, motor speed, or dynamic brake frequency of use is excessive, the dynamic brake resistance may be disconnected.	Replace the SERVO-PACK. To prevent disconnection, reduce the load.	-
	There was a failure in the dynamic brake drive circuit.	-	There is a defective component in the dynamic brake circuit. Replace the SERVO-PACK.	-
Abnormal Noise from Servomotor	The Servomotor vibrated considerably while performing the tuning-less function with the default settings.	Check the waveform of the motor speed.	Reduce the load so that the moment of inertia ratio or mass ratio is within the allowable value, or increase the load level or reduce the rigidity level in the tuning-less level settings.	*
	The machine mounting is not secure.	Check to see if there are any loose mounting screws.	Tighten the mounting screws.	-
	The machine mounting is not secure.	Check to see if there is misalignment in the coupling.	Align the coupling.	-
		Check to see if the coupling is balanced.	Balance the coupling.	-
	The bearings are defective.	Check for noise and vibration around the bearings.	Replace the Servomotor.	-
	There is a vibration source at the driven machine.	Check for any foreign matter, damage, or deformation in the machine's moving parts.	Consult with the machine manufacturer.	-
	Noise interference occurred because of incorrect I/O signal cable specifications.	Check the I/O signal cables to see if they satisfy specifications. Use shielded twisted-pair wire cables or screened twisted-pair cables with conductors of at least 0.12 mm ² .	Use cables that satisfy the specifications.	-
	Noise interference occurred because an I/O signal cable is too long.	Check the lengths of the I/O signal cables.	The I/O signal cables must be no longer than 3 m.	-
Noise interference occurred because of incorrect Encoder Cable specifications.	Make sure that the rotary or Linear Encoder Cable satisfies the specifications. Use a shielded twisted-pair wire cable or a screened twisted-pair cable with a conductors of at least 0.12 mm ² .	Use cables that satisfy the specifications.	-	

Continued on next page.

Continued from previous page.

Problem	Possible Cause	Confirmation	Correction	Reference
Abnormal Noise from Servomotor	Noise interference occurred because the Encoder Cable is too long.	Check the length of the Encoder Cable.	<ul style="list-style-type: none"> Rotary Servomotors: The Encoder Cable length must be 50 m max. Linear Servomotors: Make sure that the Serial Converter Unit cable is no longer than 20 m and that the Linear Encoder Cable and the Sensor Cable are no longer than 15 m each. 	-
	Noise interference occurred because the Encoder Cable is damaged.	Check the Encoder Cable to see if it is pinched or the sheath is damaged.	Replace the Encoder Cable and correct the cable installation environment.	-
	The Encoder Cable was subjected to excessive noise interference.	Check to see if the Encoder Cable is bundled with a high-current line or installed near a high-current line.	Correct the cable layout so that no surge is applied by high-current lines.	-
	There is variation in the FG potential because of the influence of machines on the Servomotor side, such as a welder.	Check to see if the machines are correctly grounded.	Properly ground the machines to separate them from the FG of the encoder.	-
	There is a SERVOPACK pulse counting error due to noise.	Check to see if there is noise interference on the signal line from the encoder.	Implement countermeasures against noise for the encoder wiring.	-
	The encoder was subjected to excessive vibration or shock.	Check to see if vibration from the machine occurred. Check the Servomotor installation (mounting surface precision, securing state, and alignment). Check the linear encoder installation (mounting surface precision and securing method).	Reduce machine vibration. Improve the mounting state of the Servomotor or linear encoder.	-
	A failure occurred in the encoder.	-	Replace the Servomotor.	-
	A failure occurred in the Serial Converter Unit.	-	Replace the Serial Converter Unit.	-
A failure occurred in the linear encoder.	-	Replace the linear encoder.	-	

Continued on next page.

Continued from previous page.

Problem	Possible Cause	Confirmation	Correction	Reference
Servomotor Vibrates at Frequency of Approx. 200 to 400 Hz.	The servo gains are not balanced.	Check to see if the servo gains have been correctly tuned.	Perform autotuning without a host reference.	*
	The setting of Pn100 (Speed Loop Gain) is too high.	Check the setting of Pn100. The default setting is Kv = 40.0 Hz.	Set Pn100 to an appropriate value.	-
	The setting of Pn102 (Position Loop Gain) is too high.	Check the setting of Pn102. The default setting is Kp = 40.0/s.	Set Pn102 to an appropriate value.	-
	The setting of Pn101 (Speed Loop Integral Time Constant) is not appropriate.	Check the setting of Pn101. The default setting is Ti = 20.0 ms.	Set Pn101 to an appropriate value.	-
	The setting of Pn103 (Moment of Inertia Ratio or Mass Ratio) is not appropriate.	Check the setting of Pn103.	Set Pn103 to an appropriate value.	-
Large Motor Speed Overshoot on Starting and Stopping	The servo gains are not balanced.	Check to see if the servo gains have been correctly tuned.	Perform autotuning without a host reference.	*
	The setting of Pn100 (Speed Loop Gain) is too high.	Check the setting of Pn100. The default setting is Kv = 40.0 Hz.	Set Pn100 to an appropriate value.	-
	The setting of Pn102 (Position Loop Gain) is too high.	Check the setting of Pn102. The default setting is Kp = 40.0/s.	Set Pn102 to an appropriate value.	-
	The setting of Pn101 (Speed Loop Integral Time Constant) is not appropriate.	Check the setting of Pn101. The default setting is Ti = 20.0 ms.	Set Pn101 to an appropriate value.	-
	The setting of Pn103 (Moment of Inertia Ratio or Mass Ratio) is not appropriate.	Check the setting of Pn103.	Set Pn103 to an appropriate value.	-
	The torque reference is saturated.	Check the waveform of the torque reference.	Use the mode switch.	-
	The force limits (Pn483 and Pn484) are set to the default values.	The default values of the force limits and Pn483 = 30% and Pn484 = 30%.	Set Pn483 and Pn484 to appropriate values.	*

Continued on next page.

Continued from previous page.

Problem	Possible Cause	Confirmation	Correction	Reference
Absolute Encoder Position Deviation Error (The position that was saved in the host controller when the power was turned OFF is different from the position when the power was next turned ON.)	Noise interference occurred because of incorrect Encoder Cable specifications.	Check the Encoder Cable to see if it satisfies specifications. Use a shielded twisted-pair wire cable or a screened twisted-pair cable with conductors of at least 0.12 mm ² .	Use cables that satisfy the specifications.	-
	Noise interference occurred because the Encoder Cable is too long.	Check the length of the Encoder Cable.	<ul style="list-style-type: none"> Rotary Servomotors: The Encoder Cable length must be 50 m max. Linear Servomotors: Make sure that the Serial Converter Unit cable is no longer than 20 m and that the Linear Encoder Cable and the Sensor Cable are no longer than 15 m each. 	-
	Noise interference occurred because the Encoder Cable is damaged.	Check the Encoder Cable to see if it is pinched or the sheath is damaged.	Replace the Encoder Cable and correct the cable installation environment.	-
	Replace the Encoder Cable and correct the cable installation environment.	Check to see if the Encoder Cable is bundled with a high-current line or installed near a high-current line.	Correct the cable layout so that no surge is applied by high-current lines.	-
	There is variation in the FG potential because of the influence of machines on the Servomotor side, such as a welder.	Check to see if the machines are correctly grounded.	Properly ground the machines to separate them from the FG of the encoder.	-
	There is a SERVOPACK pulse counting error due to noise.	Check to see if there is noise interference on the I/O signal line from the encoder or Serial Converter Unit.	Implement countermeasures against noise for the encoder or Serial Converter Unit wiring.	-

Continued on next page.

Continued from previous page.

Problem	Possible Cause	Confirmation	Correction	Reference
Absolute Encoder Position Deviation Error (The position that was saved in the host controller when the power was turned OFF is different from the position when the power was next turned ON.)	The encoder was subjected to excessive vibration or shock.	Check to see if vibration from the machine occurred. Check the Servomotor installation (mounting surface precision, securing state, and alignment). Check the linear encoder installation (mounting surface precision and securing method).	Reduce machine vibration. Improve the mounting state of the Servomotor or linear encoder.	-
	A failure occurred in the encoder.	-	Replace the Servomotor or linear encoder.	-
	A failure occurred in the SERVOPACK.	-	Replace the SERVOPACK.	-
	Host Controller Multiturn Data or Absolute Encoder Position Data Reading Error	Check the error detection section of the host controller.	Correct the error detection section of the host controller.	-
		Check to see if the host controller is executing data parity checks.	Perform parity checks for the multiturn data or absolute encoder position data.	-
		Check for noise interference in the cable between the SERVOPACK and the host controller.	Implement countermeasures against noise and then perform parity checks again for the multiturn data or absolute encoder position data.	-
Overtravel Occurred	The P-OT/N-OT (Forward Drive Prohibit or Reverse Drive Prohibit) signal was input.	Check the external power supply (+24 V) voltage for the input signals.	Correct the external power supply (+24 V) voltage for the input signals.	-
		Check the operating condition of the overtravel limit switches.	Make sure that the overtravel limit switches operate correctly.	-
		Check the wiring of the overtravel limit switches.	Correct the wiring of the overtravel limit switches.	*
		Check the settings of the overtravel input signal allocations (Pn50A/Pn50B).	Set the parameters to correct values.	*
	The P-OT/N-OT (Forward Drive Prohibit or Reverse Drive Prohibit) signal malfunctioned.	Check for fluctuation in the external power supply (+24 V) voltage for the input signals.	Eliminate fluctuation from the external power supply (+24 V) voltage for the input signals.	-
		Check to see if the operation of the overtravel limit switches is unstable.	Stabilize the operating condition of the overtravel limit switches.	-
		Check the wiring of the overtravel limit switches (e.g., check for cable damage and loose screws).	Correct the wiring of the overtravel limit switches.	-

Continued on next page.

Continued from previous page.

Problem	Possible Cause	Confirmation	Correction	Reference
Overtravel Occurred	There is a mistake in the allocation of the P-OT or N-OT (Forward Drive Prohibit or Reverse Drive Prohibit) signal in Pn50A = n.X□□□ or Pn50B = n.□□□X.	Check to see if the P-OT signal is allocated in Pn50A = n.X□□□.	If another signal is allocated in Pn50A = n.X□□□, allocate the P-OT signal instead.	*
		Check to see if the N-OT signal is allocated in Pn50B = n.□□□X.	If another signal is allocated in Pn50B = n.□□□X, allocate the N-OT signal instead.	*
	The selection of the Servomotor stopping method is not correct.	Check the servo OFF stopping method set in Pn001 = n.□□□X or Pn001 = n.□□X□.	Select a Servomotor stopping method other than coasting to a stop.	*
		Check the torque control stopping method set in Pn001 = n.□□□X or Pn001 = n.□□X□.	Select a Servomotor stopping method other than coasting to a stop.	*
Improper Stop Position for Overtravel (OT) Signal	The limit switch position and dog length are not appropriate.	–	Install the limit switch at the appropriate position.	–
	The overtravel limit switch position is too close for the coasting distance.	–	Install the overtravel limit switch at the appropriate position.	–
Position Deviation (without Alarm)	Noise interference occurred because of incorrect Encoder Cable specifications.	Check the Encoder Cable to see if it satisfies specifications. Use a shielded twisted-pair wire cable or a screened twisted-pair cable with conductors of at least 0.12 mm ² .	Use cables that satisfy the specifications.	–
	Noise interference occurred because the Encoder Cable is too long.	Check the length of the Encoder Cable.	<ul style="list-style-type: none"> Rotary Servomotors: The Encoder Cable length must be 50 m max. Linear Servomotors: Make sure that the Serial Converter Unit cable is no longer than 20 m and that the Linear Encoder Cable and the Sensor Cable are no longer than 15 m each. 	–
	Noise interference occurred because the Encoder Cable is damaged.	Check the Encoder Cable to see if it is pinched or the sheath is damaged.	Replace the Encoder Cable and correct the cable installation environment.	–
	The Encoder Cable was subjected to excessive noise interference.	Check to see if the Encoder Cable is bundled with a high-current line or installed near a high-current line.	Correct the cable layout so that no surge is applied by high-current lines.	–
	There is variation in the FG potential because of the influence of machines on the Servomotor side, such as a welder.	Check to see if the machines are correctly grounded.	Properly ground the machines to separate them from the FG of the encoder.	–
	There is a SERVOPACK pulse counting error due to noise.	Check to see if there is noise interference on the I/O signal line from the encoder or Serial Converter Unit.	Implement countermeasures against noise for the encoder wiring or Serial Converter Unit wiring.	–

Continued on next page.

Continued from previous page.

Problem	Possible Cause	Confirmation	Correction	Reference
Position Deviation (without Alarm)	The encoder was subjected to excessive vibration or shock.	Check to see if vibration from the machine occurred. Check the Servomotor installation (mounting surface precision, securing state, and alignment). Check the linear encoder installation (mounting surface precision and securing method).	Reduce machine vibration. Improve the mounting state of the Servomotor or linear encoder.	-
	The coupling between the machine and Servomotor is not suitable.	Check to see if position offset occurs at the coupling between machine and Servomotor.	Correctly secure the coupling between the machine and Servomotor.	-
	Noise interference occurred because of incorrect I/O signal cable specifications.	Check the I/O signal cables to see if they satisfy specifications. Use a shielded twisted-pair wire cable or a screened twisted-pair cable with conductors of at least 0.12 mm ² .	Use cables that satisfy the specifications.	-
Position Deviation (without Alarm)	Noise interference occurred because an I/O signal cable is too long.	Check the lengths of the I/O signal cables.	The I/O signal cables must be no longer than 3 m.	-
	An encoder fault occurred. (The pulse count does not change.)	-	Replace the Servomotor or linear encoder.	-
	A failure occurred in the SERVOPACK.	-	Replace the SERVOPACK.	-
Servomotor Overheated	The surrounding air temperature is too high.	Measure the surrounding air temperature around the Servomotor.	Reduce the surrounding air temperature to 40°C or less.	-
	The surface of the Servomotor is dirty.	Visually check the surface for dirt.	Clean dirt, dust, and oil from the surface.	-
	There is an overload on the Servomotor.	Check the load status with a monitor.	If the Servomotor is overloaded, reduce the load or replace the Servo Drive with a SERVOPACK and Servomotor with larger capacities.	-
	Polarity detection was not performed correctly.	Check to see if electrical angle 2 (electrical angle from polarity origin) at any position is between $\pm 10^\circ$.	Correct the settings for the polarity detection-related parameters.	-

* Refer to the following manual for details.

 Σ -7-Series Σ -7S SERVOPACK with MECHATROLINK-III Communications References Product Manual (Manual No.: SIEP S800001 28)

Parameter Lists



This chapter provides information on the parameters.

5.1 SERVOPACKs with Analog Voltage/Pulse Train References . . . 5-2

- 5.1.1 Interpreting the Parameter Lists 5-2
- 5.1.2 List of Parameters 5-3
- 5.1.3 Parameter Recording Table 5-35

5.2 SERVOPACKs with MECHATROLINK-III Communications References . . 5-43

- 5.2.1 Interpreting the Parameter Lists 5-43
- 5.2.2 List of Servo Parameters 5-44
- 5.2.3 List of MECHATROLINK-III Common
Parameters 5-84
- 5.2.4 Parameter Recording Table 5-92

5.1 SERVOPACKs with Analog Voltage/Pulse Train References

5.1.1 Interpreting the Parameter Lists

The types of motors to which the parameter applies.

- All: The parameter is used for both Rotary Servomotors and Linear Servomotors.
- Rotary: The parameter is used for only Rotary Servomotors.
- Linear: The parameter is used for only Linear Servomotors.

Rotary Servomotor terms are used for parameters that are applicable to all Servomotors. If you are using a Linear Servomotor, you need to interpret the terms accordingly. Refer to the following section for details.

◆ Differences in Terms for Rotary Servomotors and Linear Servomotors on page ix

Indicates when a change to the parameter will be effective.

Parameter No.	Size	Name	Setting Range	Setting Unit	Default Setting	Applicable Motors	When Enabled	Classification	Reference
Pn000	2	Basic Function Selections 0	0000 to 10B1	-	0000	All	After restart	Setup	-
	n.□□□X		Rotation Direction Selection Movement Direction Selection		Reference				
	0		Use CCW as the forward direction.		-				
	1		Use the direction in which the linear encoder counts up as the forward direction.						
	1		Use CW as the forward direction. (Reverse Rotation Mode)						
	1		Use the direction in which the linear encoder counts down as the forward direction. (Reverse Movement Mode)						
	n.□□□□		Control Method Selection		Reference				
	0		Speed control with analog references		-				
	1		Position control with pulse train references						
	2		Torque control with analog references						
3		Internal set speed control with contact commands							
4		Switching between internal set speed control with contact references and speed control with analog references							
5		Switching between internal set speed control with contact references and position control with pulse train references							
6		Switching between internal set speed control with contact references and torque control with analog references							
7		Switching between position control with pulse train references and speed control with analog references							
8		Switching between position control with pulse train references and torque control with analog references							
9		Switching between torque control with analog references and speed control with analog references							
A		Switching between speed control with analog references and speed control with zero clamping							
B		Switching between position control with pulse train references and position control with reference pulse inhibition							
n.□X□□		Reserved parameter (Do not change.)							
n.X□□□		Rotary/Linear Servomotor Startup Selection When Encoder Is Not Connected		Reference					
0		When an encoder is not connected, start as SERVOPACK for Rotary Servomotor.		-					
1		When an encoder is not connected, start as SERVOPACK for Linear Servomotor.							

If there are differences in the parameters for Rotary Servomotor and Linear Servomotor, information is provided for both.

- Top row: For Rotary Servomotors
- Bottom row: For Linear Servomotors

There are the following two classifications.

- Setup
- Tuning

Refer to the following manual for details.

Σ-7-Series Σ-7S SERVOPACK with Analog Voltage/Pulse Train References Product Manual (Manual No.: S1EP S800001 26)

5.1.2 List of Parameters

The following table lists the parameters.

Note: Do not change the following parameters from their default settings.

- Reserved parameters
- Parameters not given in this manual
- Parameters that are not valid for the Servomotor that you are using, as given in the parameter table

Parameter No.	Size	Name	Setting Range	Setting Unit	Default Setting	Applicable Motors	When Enabled	Classification	Reference																											
Pn000	2	Basic Function Selections 0	0000 to 10B1	–	0000	All	After restart	Setup	*1																											
	n.□□□X		<table border="1"> <thead> <tr> <th colspan="2">Rotation Direction Selection</th> </tr> <tr> <th colspan="2">Movement Direction Selection</th> </tr> </thead> <tbody> <tr> <td>0</td> <td>Use CCW as the forward direction. Use the direction in which the linear encoder counts up as the forward direction.</td> </tr> <tr> <td>1</td> <td>Use CW as the forward direction. (Reverse Rotation Mode) Use the direction in which the linear encoder counts down as the forward direction. (Reverse Movement Mode)</td> </tr> </tbody> </table>								Rotation Direction Selection		Movement Direction Selection		0	Use CCW as the forward direction. Use the direction in which the linear encoder counts up as the forward direction.	1	Use CW as the forward direction. (Reverse Rotation Mode) Use the direction in which the linear encoder counts down as the forward direction. (Reverse Movement Mode)																		
	Rotation Direction Selection																																			
	Movement Direction Selection																																			
	0	Use CCW as the forward direction. Use the direction in which the linear encoder counts up as the forward direction.																																		
	1	Use CW as the forward direction. (Reverse Rotation Mode) Use the direction in which the linear encoder counts down as the forward direction. (Reverse Movement Mode)																																		
	n.□□X□		<table border="1"> <thead> <tr> <th colspan="2">Control Method Selection</th> </tr> </thead> <tbody> <tr> <td>0</td> <td>Speed control with analog references</td> </tr> <tr> <td>1</td> <td>Position control with pulse train references</td> </tr> <tr> <td>2</td> <td>Torque control with analog references</td> </tr> <tr> <td>3</td> <td>Internal set speed control with contact commands</td> </tr> <tr> <td>4</td> <td>Switching between internal set speed control with contact references and speed control with analog references</td> </tr> <tr> <td>5</td> <td>Switching between internal set speed control with contact references and position control with pulse train references</td> </tr> <tr> <td>6</td> <td>Switching between internal set speed control with contact references and torque control with analog references</td> </tr> <tr> <td>7</td> <td>Switching between position control with pulse train references and speed control with analog references</td> </tr> <tr> <td>8</td> <td>Switching between position control with pulse train references and torque control with analog references</td> </tr> <tr> <td>9</td> <td>Switching between torque control with analog references and speed control with analog references</td> </tr> <tr> <td>A</td> <td>Switching between speed control with analog references and speed control with zero clamping</td> </tr> <tr> <td>B</td> <td>Switching between position control with pulse train references and position control with reference pulse inhibition</td> </tr> </tbody> </table>								Control Method Selection		0	Speed control with analog references	1	Position control with pulse train references	2	Torque control with analog references	3	Internal set speed control with contact commands	4	Switching between internal set speed control with contact references and speed control with analog references	5	Switching between internal set speed control with contact references and position control with pulse train references	6	Switching between internal set speed control with contact references and torque control with analog references	7	Switching between position control with pulse train references and speed control with analog references	8	Switching between position control with pulse train references and torque control with analog references	9	Switching between torque control with analog references and speed control with analog references	A	Switching between speed control with analog references and speed control with zero clamping	B	Switching between position control with pulse train references and position control with reference pulse inhibition
	Control Method Selection																																			
	0	Speed control with analog references																																		
	1	Position control with pulse train references																																		
	2	Torque control with analog references																																		
	3	Internal set speed control with contact commands																																		
	4	Switching between internal set speed control with contact references and speed control with analog references																																		
	5	Switching between internal set speed control with contact references and position control with pulse train references																																		
	6	Switching between internal set speed control with contact references and torque control with analog references																																		
	7	Switching between position control with pulse train references and speed control with analog references																																		
	8	Switching between position control with pulse train references and torque control with analog references																																		
	9	Switching between torque control with analog references and speed control with analog references																																		
	A	Switching between speed control with analog references and speed control with zero clamping																																		
	B	Switching between position control with pulse train references and position control with reference pulse inhibition																																		
	n.□X□□		Reserved parameter (Do not change.)																																	
	n.X□□□		<table border="1"> <thead> <tr> <th colspan="2">Rotary/Linear Servomotor Startup Selection When Encoder Is Not Connected</th> </tr> </thead> <tbody> <tr> <td>0</td> <td>When an encoder is not connected, start as SERVOPACK for Rotary Servomotor.</td> </tr> <tr> <td>1</td> <td>When an encoder is not connected, start as SERVOPACK for Linear Servomotor.</td> </tr> </tbody> </table>								Rotary/Linear Servomotor Startup Selection When Encoder Is Not Connected		0	When an encoder is not connected, start as SERVOPACK for Rotary Servomotor.	1	When an encoder is not connected, start as SERVOPACK for Linear Servomotor.																				
	Rotary/Linear Servomotor Startup Selection When Encoder Is Not Connected																																			
	0	When an encoder is not connected, start as SERVOPACK for Rotary Servomotor.																																		
	1	When an encoder is not connected, start as SERVOPACK for Linear Servomotor.																																		

Continued on next page.

5.1 SERVOPACKs with Analog Voltage/Pulse Train References

5.1.2 List of Parameters

Continued from previous page.

Parameter No.	Size	Name	Setting Range	Setting Unit	Default Setting	Applicable Motors	When Enabled	Classification	Reference													
Pn001	2	Application Function Selections 1	0000 to 1142	-	0000	All	After restart	Setup	*1													
	<table border="1"> <thead> <tr> <th colspan="2">Motor Stopping Method for Servo OFF and Group 1 Alarms</th> </tr> </thead> <tbody> <tr> <td rowspan="3">n.□□□X</td> <td>0</td> <td>Stop the motor by applying the dynamic brake.</td> </tr> <tr> <td>1</td> <td>Stop the motor by the applying dynamic brake and then release the dynamic brake.</td> </tr> <tr> <td>2</td> <td>Coast the motor to a stop without the dynamic brake.</td> </tr> </tbody> </table>									Motor Stopping Method for Servo OFF and Group 1 Alarms		n.□□□X	0	Stop the motor by applying the dynamic brake.	1	Stop the motor by the applying dynamic brake and then release the dynamic brake.	2	Coast the motor to a stop without the dynamic brake.				
	Motor Stopping Method for Servo OFF and Group 1 Alarms																					
	n.□□□X	0	Stop the motor by applying the dynamic brake.																			
		1	Stop the motor by the applying dynamic brake and then release the dynamic brake.																			
		2	Coast the motor to a stop without the dynamic brake.																			
	<table border="1"> <thead> <tr> <th colspan="2">Overtravel Stopping Method</th> </tr> </thead> <tbody> <tr> <td rowspan="5">n.□□X□</td> <td>0</td> <td>Apply the dynamic brake or coast the motor to a stop (use the stopping method set in Pn001 = n.□□□X).</td> </tr> <tr> <td>1</td> <td>Decelerate the motor to a stop using the torque set in Pn406 as the maximum torque and then servo-lock the motor.</td> </tr> <tr> <td>2</td> <td>Decelerate the motor to a stop using the torque set in Pn406 as the maximum torque and then let the motor coast.</td> </tr> <tr> <td>3</td> <td>Decelerate the motor to a stop using the deceleration time set in Pn30A and then servo-lock the motor.</td> </tr> <tr> <td>4</td> <td>Decelerate the motor to a stop using the deceleration time set in Pn30A and then let the motor coast.</td> </tr> </tbody> </table>									Overtravel Stopping Method		n.□□X□	0	Apply the dynamic brake or coast the motor to a stop (use the stopping method set in Pn001 = n.□□□X).	1	Decelerate the motor to a stop using the torque set in Pn406 as the maximum torque and then servo-lock the motor.	2	Decelerate the motor to a stop using the torque set in Pn406 as the maximum torque and then let the motor coast.	3	Decelerate the motor to a stop using the deceleration time set in Pn30A and then servo-lock the motor.	4	Decelerate the motor to a stop using the deceleration time set in Pn30A and then let the motor coast.
	Overtravel Stopping Method																					
	n.□□X□	0	Apply the dynamic brake or coast the motor to a stop (use the stopping method set in Pn001 = n.□□□X).																			
		1	Decelerate the motor to a stop using the torque set in Pn406 as the maximum torque and then servo-lock the motor.																			
		2	Decelerate the motor to a stop using the torque set in Pn406 as the maximum torque and then let the motor coast.																			
		3	Decelerate the motor to a stop using the deceleration time set in Pn30A and then servo-lock the motor.																			
		4	Decelerate the motor to a stop using the deceleration time set in Pn30A and then let the motor coast.																			
	<table border="1"> <thead> <tr> <th colspan="2">Main Circuit Power Supply AC/DC Input Selection</th> </tr> </thead> <tbody> <tr> <td rowspan="2">n.□X□□</td> <td>0</td> <td>Input AC power as the main circuit power supply using the L1, L2, and L3 terminals (do not use shared converter).</td> </tr> <tr> <td>1</td> <td>Input DC power as the main circuit power supply using the B1/⊕ and ⊖ 2 terminals or the B1 and ⊖ 2 terminals (use an external converter or the shared converter).</td> </tr> </tbody> </table>									Main Circuit Power Supply AC/DC Input Selection		n.□X□□	0	Input AC power as the main circuit power supply using the L1, L2, and L3 terminals (do not use shared converter).	1	Input DC power as the main circuit power supply using the B1/⊕ and ⊖ 2 terminals or the B1 and ⊖ 2 terminals (use an external converter or the shared converter).						
	Main Circuit Power Supply AC/DC Input Selection																					
	n.□X□□	0	Input AC power as the main circuit power supply using the L1, L2, and L3 terminals (do not use shared converter).																			
		1	Input DC power as the main circuit power supply using the B1/⊕ and ⊖ 2 terminals or the B1 and ⊖ 2 terminals (use an external converter or the shared converter).																			
	<table border="1"> <thead> <tr> <th colspan="2">Warning Code Output Selection</th> </tr> </thead> <tbody> <tr> <td rowspan="2">n.X□□□</td> <td>0</td> <td>Output only alarm codes on the ALO1, ALO2, and ALO3 terminals.</td> </tr> <tr> <td>1</td> <td>Output both warning codes and alarm codes on the ALO1, ALO2, and ALO3 terminals. However, while a warning code is being output, the ALM (Servo Alarm) output signal will remain ON (normal state).</td> </tr> </tbody> </table>									Warning Code Output Selection		n.X□□□	0	Output only alarm codes on the ALO1, ALO2, and ALO3 terminals.	1	Output both warning codes and alarm codes on the ALO1, ALO2, and ALO3 terminals. However, while a warning code is being output, the ALM (Servo Alarm) output signal will remain ON (normal state).						
	Warning Code Output Selection																					
	n.X□□□	0	Output only alarm codes on the ALO1, ALO2, and ALO3 terminals.																			
1		Output both warning codes and alarm codes on the ALO1, ALO2, and ALO3 terminals. However, while a warning code is being output, the ALM (Servo Alarm) output signal will remain ON (normal state).																				

Continued on next page.

Continued from previous page.

Parameter No.	Size	Name	Setting Range	Setting Unit	Default Setting	Applicable Motors	When Enabled	Classification	Reference	
Pn002	2	Application Function Selections 2	0000 to 4213	-	0000	-	After restart	Setup	*1	
			Speed/Position Control Option (T-REF Input Allocation)						Applicable Motors	
	n.□□□X		0	Do not use T-REF.					All	
			1	Use T-REF as an external torque limit input.						
			2	Use T-REF as a torque feedback input.						
			3	Use T-REF as an external torque limit input when /P-CL or /N-CL is ON.						
			Torque Control Option (V-REF Input Allocation)						Applicable Motors	
	n.□□X□		0	Do not use V-REF.					All	
			1	Use V-REF as an external speed limit input.						
			Encoder Usage						Applicable Motors	
	n.□X□□		0	Use the encoder according to encoder specifications.					All	
			1	Use the encoder as an incremental encoder.						
			2	Use the encoder as a single-turn absolute encoder.						Rotary
			External Encoder Usage						Applicable Motors	
	n.X□□□		0	Do not use an external encoder.					Rotary	
			1	The external encoder moves in the forward direction for CCW motor rotation.						
			2	Reserved setting (Do not use.)						
			3	The external encoder moves in the reverse direction for CCW motor rotation.						
			4	Reserved setting (Do not use.)						

Continued on next page.

5.1 SERVOPACKs with Analog Voltage/Pulse Train References

5.1.2 List of Parameters

Continued from previous page.

Parameter No.	Size	Name	Setting Range	Setting Unit	Default Setting	Applicable Motors	When Enabled	Classification	Reference		
Pn006	2	Application Function Selections 6	0000 to 105F	–	0002	All	Immediately	Setup	*1		
	n.□□XX	Analog Monitor 1 Signal Selection									
		00	Motor speed (1 V/1,000 min ⁻¹) Motor speed (1 V/1,000 mm/s)								
		01	Speed reference (1 V/1,000 min ⁻¹) Speed reference (1 V/1,000 mm/s)								
		02	Torque reference (1 V/100% rated torque) Force reference (1 V/100% rated force)								
		03	Position deviation (0.05 V/reference unit)								
		04	Position amplifier deviation (after electronic gear) (0.05 V/encoder pulse unit) Position amplifier deviation (after electronic gear) (0.05 V/linear encoder pulse unit)								
		05	Position reference speed (1 V/1,000 min ⁻¹) Position reference speed (1 V/1,000 mm/s)								
		06	Reserved setting (Do not use.)								
		07	Load-motor position deviation (0.01 V/reference unit)								
		08	Positioning completion (positioning completed: 5 V, positioning not completed: 0 V)								
		09	Speed feedforward (1 V/1,000 min ⁻¹) Speed feedforward (1 V/1,000 mm/s)								
		0A	Torque feedforward (1 V/100% rated torque) Force feedforward (1 V/100% rated force)								
		0B	Active gain (1st gain: 1 V, 2nd gain: 2 V)								
		0C	Completion of position reference distribution (completed: 5 V, not completed: 0 V)								
		0D	External encoder speed (1 V/1,000 min ⁻¹ : value at the motor shaft)								
		0E	Reserved setting (Do not use.)								
		0F	Reserved setting (Do not use.)								
		10	Main circuit DC voltage								
		11 to 24	Reserved settings (Do not use.)								
		25	Position deviation after position reference filter (0.05 V/reference unit)								
		26 to 5F	Reserved settings (Do not use.)								
		n.□X□□	Reserved parameter (Do not change.)								
		n.X□□□	Reserved parameter (Do not change.)								

Continued on next page.

Continued from previous page.

Parameter No.	Size	Name	Setting Range	Setting Unit	Default Setting	Applicable Motors	When Enabled	Classification	Reference		
Pn007	2	Application Function Selections 7	0000 to 105F	–	0000	All	Immediately	Setup	*1		
	n.□□XX	Analog Monitor 2 Signal Selection									
		00	Motor speed (1 V/1,000 min ⁻¹) Motor speed (1 V/1,000 mm/s)								
		01	Speed reference (1 V/1,000 min ⁻¹) Speed reference (1 V/1,000 mm/s)								
		02	Torque reference (1 V/100% rated torque) Force reference (1 V/100% rated force)								
		03	Position deviation (0.05 V/reference unit)								
		04	Position amplifier deviation (after electronic gear) (0.05 V/encoder pulse unit) Position amplifier deviation (after electronic gear) (0.05 V/linear encoder pulse unit)								
		05	Position reference speed (1 V/1,000 min ⁻¹) Position reference speed (1 V/1,000 mm/s)								
		06	Reserved setting (Do not use.)								
		07	Load-motor position deviation (0.01 V/reference unit)								
		08	Positioning completion (positioning completed: 5 V, positioning not completed: 0 V)								
		09	Speed feedforward (1 V/1,000 min ⁻¹) Speed feedforward (1 V/1,000 mm/s)								
		0A	Torque feedforward (1 V/100% rated torque) Force feedforward (1 V/100% rated force)								
		0B	Active gain (1st gain: 1 V, 2nd gain: 2 V)								
		0C	Completion of position reference distribution (completed: 5 V, not completed: 0 V)								
		0D	External encoder speed (1 V/1,000 min ⁻¹ : value at the motor shaft)								
		0E	Reserved setting (Do not use.)								
		0F	Reserved setting (Do not use.)								
		10	Main circuit DC voltage								
		11 to 24	Reserved settings (Do not use.)								
		25	Position deviation after position reference filter (0.05 V/reference unit)								
		26 to 5F	Reserved settings (Do not use.)								
		n.□X□□	Reserved parameter (Do not change.)								
		n.X□□□	Reserved parameter (Do not change.)								

Continued on next page.

5.1 SERVOPACKs with Analog Voltage/Pulse Train References

5.1.2 List of Parameters

Continued from previous page.

Parameter No.	Size	Name	Setting Range	Setting Unit	Default Setting	Applicable Motors	When Enabled	Classification	Reference	
Pn008	2	Application Function Selections 8	0000 to 7121	–	0000	Rotary	After restart	Setup	*1	
	n.□□□X		Low Battery Voltage Alarm/Warning Selection							
			0	Output alarm (A.830) for low battery voltage.						
			1	Output warning (A.930) for low battery voltage.						
	n.□□X□		Function Selection for Undervoltage							
			0	Do not detect undervoltage.						
			1	Detect undervoltage warning and limit torque at host controller.						
			2	Detect undervoltage warning and limit torque with Pn424 and Pn425 (i.e., only in SERVOPACK).						
	n.□X□□		Warning Detection Selection							
			0	Detect warnings.						
		1	Do not detect warnings except for A.971.							
n.X□□□		Reserved parameter (Do not change.)								
Pn009	2	Application Function Selections 9	0000 to 0121	–	0010	All	After restart	Tuning	*1	
	n.□□□X		Reserved parameter (Do not change.)							
	n.□□X□		Current Control Mode Selection							
			0	Use current control mode 1.						
			1	<ul style="list-style-type: none"> • SERVOPACK Models SGD7S-R70A, -R90A, -1R6A, -2R8A, -5R5A, and -7R6A: Use current control mode 1. • SERVOPACK Models SGD7S-120A, -180A, -200A, -330A, -470A, -550A, -590A, and -780A: Use current control mode 2. 						
			2	Use current control mode 2.						
	n.□X□□		Speed Detection Method Selection							
			0	Use speed detection 1.						
			1	Use speed detection 2.						
	n.X□□□		Reserved parameter (Do not change.)							

Continued on next page.

Continued from previous page.

Parameter No.	Size	Name	Setting Range	Setting Unit	Default Setting	Applicable Motors	When Enabled	Classification	Reference	
Pn00A	2	Application Function Selections A	0000 to 0044	–	0001	All	After restart	Setup	*1	
	n.□□□X	Motor Stopping Method for Group 2 Alarms								
		0	Apply the dynamic brake or coast the motor to a stop (use the stopping method set in Pn001 = n.□□□X).							
		1	Decelerate the motor to a stop using the torque set in Pn406 as the maximum torque. Use the setting of Pn001 = n.□□□X for the status after stopping.							
		2	Decelerate the motor to a stop using the torque set in Pn406 as the maximum torque and then let the motor coast.							
		3	Decelerate the motor to a stop using the deceleration time set in Pn30A. Use the setting of Pn001 = n.□□□X for the status after stopping.							
	4	Decelerate the motor to a stop using the deceleration time set in Pn30A and then let the motor coast.								
	n.□□X□	Stopping Method for Forced Stops								
		0	Apply the dynamic brake or coast the motor to a stop (use the stopping method set in Pn001 = n.□□□X).							
		1	Decelerate the motor to a stop using the torque set in Pn406 as the maximum torque. Use the setting of Pn001 = n.□□□X for the status after stopping.							
		2	Decelerate the motor to a stop using the torque set in Pn406 as the maximum torque and then let the motor coast.							
		3	Decelerate the motor to a stop using the deceleration time set in Pn30A. Use the setting of Pn001 = n.□□□X for the status after stopping.							
	4	Decelerate the motor to a stop using the deceleration time set in Pn30A and then let the motor coast.								
	n.□X□□	Reserved parameter (Do not change.)								
n.X□□□	Reserved parameter (Do not change.)									
Pn00B	2	Application Function Selections B	0000 to 1121	–	0000	All	After restart	Setup	*1	
	n.□□□X	Operator Parameter Display Selection								
		0	Display only setup parameters.							
	1	Display all parameters.								
	n.□□X□	Motor Stopping Method for Group 2 Alarms								
		0	Stop the motor by setting the speed reference to 0.							
		1	Apply the dynamic brake or coast the motor to a stop (use the stopping method set in Pn001 = n.□□□X).							
	2	Set the stopping method with Pn00A = n.□□□X.								
	n.□X□□	Power Input Selection for Three-phase SERVOPACK								
		0	Use a three-phase power supply input.							
1	Use a three-phase power supply input as a single-phase power supply input.									
n.X□□□	Reserved parameter (Do not change.)									

Continued on next page.

5.1 SERVOPACKs with Analog Voltage/Pulse Train References

5.1.2 List of Parameters

Continued from previous page.

Parameter No.	Size	Name	Setting Range	Setting Unit	Default Setting	Applicable Motors	When Enabled	Classification	Reference		
Pn00C	2	Application Function Selections C	0000 to 0131	-	0000	-	After restart	Setup	*1		
	n.□□□X		Function Selection for Test without a Motor						Applicable Motors		
			0	Disable tests without a motor.						All	
			1	Enable tests without a motor.							
	n.□□X□		Encoder Resolution for Tests without a Motor						Applicable Motors		
			0	Use 13 bits.						Rotary	
			1	Use 20 bits.							
			2	Use 22 bits.							
			3	Use 24 bits.							
	n.□X□□		Encoder Type Selection for Tests without a Motor						Applicable Motors		
		0	Use an incremental encoder.						All		
		1	Use an absolute encoder.								
n.X□□□		Reserved parameter (Do not change.)									
Pn00D	2	Application Function Selections D	0000 to 1001	-	0000	All	After restart	Setup	*1		
	n.□□□X		Reserved parameter (Do not change.)								
	n.□□X□		Reserved parameter (Do not change.)								
	n.□X□□		Reserved parameter (Do not change.)								
	n.X□□□		Overtravel Warning Detection Selection								
		0	Do not detect overtravel warnings.								
		1	Detect overtravel warnings.								
Pn00F	2	Application Function Selections F	0000 to 2011	-	0000	All	After restart	Setup	*1		
	n.□□□X		Preventative Maintenance Warning Selection								
			0	Do not detect preventative maintenance warnings.							
			1	Detect preventative maintenance warnings.							
	n.□□X□		Reserved parameter (Do not change.)								
	n.□X□□		Reserved parameter (Do not change.)								
n.X□□□		Reserved parameter (Do not change.)									
Pn010	2	Axis Address Selection for UART/USB Communications	0000 to 007F	-	0001	All	After restart	Setup	-		
Pn021	2	Reserved parameter (Do not change.)	-	-	0000	All	-	-	-		

Continued on next page.

Continued from previous page.

Parameter No.	Size	Name	Setting Range	Setting Unit	Default Setting	Applicable Motors	When Enabled	Classification	Reference	
Pn040	2	Σ-V Compatible Function Switch	0000 to 2111	–	0000	–	After restart	Setup	–	
	n.□□□X		Reserved parameter (Do not change.)							
	n.□□□□	Encoder Resolution Compatibility Selection							Applicable Motors	
		0	Use the encoder resolution of the connected motor.							Rotary
	1	Use a resolution of 20 bits when connected to an SGM7J, SGM7A, SGM7P, or SGM7G Servomotor.								
	n.□X□□		Reserved parameter (Do not change.)							
n.X□□□		Reserved parameter (Do not change.)								
Pn080	2	Application Function Selections 80	0000 to 1111	–	0000	Linear	After restart	Setup	*1	
	n.□□□X	Polarity Sensor Selection								
		0	Use polarity sensor.							
		1	Do not use polarity sensor.							
	n.□□□□	Motor Phase Sequence Selection								
		0	Set a phase-A lead as a phase sequence of U, V, and W.							
1	Set a phase-B lead as a phase sequence of U, V, and W.									
n.□X□□		Reserved parameter (Do not change.)								
n.X□□□	Calculation Method for Maximum Speed or Encoder Output Pulses									
	0	Calculate the encoder output pulse setting for a fixed maximum speed.								
1	Calculate the maximum speed for a fixed encoder output pulse setting.									
Pn081	2	Application Function Selections 81	0000 to 1111	–	0000	All	After restart	Setup	*1	
	n.□□□X	Phase-C Pulse Output Selection								
		0	Output phase-C pulses only in the forward direction.							
	1	Output phase-C pulses in both the forward and reverse directions.								
	n.□□X□		Reserved parameter (Do not change.)							
	n.□X□□		Reserved parameter (Do not change.)							
n.X□□□		Reserved parameter (Do not change.)								
Pn100	2	Speed Loop Gain	10 to 20,000	0.1 Hz	400	All	Immediately	Tuning	*1	
Pn101	2	Speed Loop Integral Time Constant	15 to 51,200	0.01 ms	2000	All	Immediately	Tuning	*1	
Pn102	2	Position Loop Gain	10 to 20,000	0.1/s	400	All	Immediately	Tuning	*1	
Pn103	2	Moment of Inertia Ratio	0 to 20,000	1%	100	All	Immediately	Tuning	*1	
Pn104	2	Second Speed Loop Gain	10 to 20,000	0.1 Hz	400	All	Immediately	Tuning	*1	
Pn105	2	Second Speed Loop Integral Time Constant	15 to 51,200	0.01 ms	2000	All	Immediately	Tuning	*1	
Pn106	2	Second Position Loop Gain	10 to 20,000	0.1/s	400	All	Immediately	Tuning	*1	

Continued on next page.

5.1 SERVOPACKs with Analog Voltage/Pulse Train References

5.1.2 List of Parameters

Continued from previous page.

Parameter No.	Size	Name	Setting Range	Setting Unit	Default Setting	Applicable Motors	When Enabled	Classification	Reference	
Pn109	2	Feedforward	0 to 100	1%	0	All	Immediately	Tuning	*1	
Pn10A	2	Feedforward Filter Time Constant	0 to 6,400	0.01 ms	0	All	Immediately	Tuning	*1	
Pn10B	2	Gain Application Selections	0000 to 5334	–	0004	All	–	Setup	*1	
			Mode Switching Selection						When Enabled	
	n.□□□X		0	Use the internal torque reference as the condition (level setting: Pn10C).				Immediately		
			1	Use the speed reference as the condition (level setting: Pn10D).						
				Use the speed reference as the condition (level setting: Pn181).						
			2	Use the acceleration reference as the condition (level setting: Pn10E).						
				Use the acceleration reference as the condition (level setting: Pn182).						
			3	Use the position deviation as the condition (level setting: Pn10F).						
			4	Do not use mode switching.						
			Speed Loop Control Method						When Enabled	
n.□□□X□		0	PI control				After restart			
		1	I-P control							
		2 to 3	Reserved settings (Do not use.)							
n.□X□□		Reserved parameter (Do not change.)								
n.X□□□		Reserved parameter (Do not change.)								
Pn10C	2	Mode Switching Level for Torque Reference	0 to 800	1%	200	All	Immediately	Tuning	*1	
Pn10D	2	Mode Switching Level for Speed Reference	0 to 10,000	1 min ⁻¹	0	Rotary	Immediately	Tuning	*1	
Pn10E	2	Mode Switching Level for Acceleration	0 to 30,000	1 min ⁻¹ /s	0	Rotary	Immediately	Tuning	*1	
Pn10F	2	Mode Switching Level for Position Deviation	0 to 10,000	1 reference unit	0	All	Immediately	Tuning	*1	
Pn11F	2	Position Integral Time Constant	0 to 50,000	0.1 ms	0	All	Immediately	Tuning	*1	
Pn121	2	Friction Compensation Gain	10 to 1,000	1%	100	All	Immediately	Tuning	*1	
Pn122	2	Second Friction Compensation Gain	10 to 1,000	1%	100	All	Immediately	Tuning	*1	
Pn123	2	Friction Compensation Coefficient	0 to 100	1%	0	All	Immediately	Tuning	*1	
Pn124	2	Friction Compensation Frequency Correction	-10,000 to 10,000	0.1 Hz	0	All	Immediately	Tuning	*1	
Pn125	2	Friction Compensation Gain Correction	1 to 1,000	1%	100	All	Immediately	Tuning	*1	
Pn131	2	Gain Switching Time 1	0 to 65,535	1 ms	0	All	Immediately	Tuning	*1	
Pn132	2	Gain Switching Time 2	0 to 65,535	1 ms	0	All	Immediately	Tuning	*1	
Pn135	2	Gain Switching Waiting Time 1	0 to 65,535	1 ms	0	All	Immediately	Tuning	*1	
Pn136	2	Gain Switching Waiting Time 2	0 to 65,535	1 ms	0	All	Immediately	Tuning	*1	

Continued on next page.

Continued from previous page.

Parameter No.	Size	Name	Setting Range	Setting Unit	Default Setting	Applicable Motors	When Enabled	Classification	Reference	
Pn139	2	Automatic Gain Switching Selections 1	0000 to 0052	–	0000	All	Immediately	Tuning	*1	
	n.□□□X	Gain Switching Selection		0	Use manual gain switching. The gain is switched manually with the /G-SEL (Gain Selection) signal.					
				1	Reserved setting (Do not use.)					
				2	Use automatic gain switching pattern 1. The gain is switched automatically from the first gain to the second gain when switching condition A is satisfied. The gain is switched automatically from the second gain to the first gain when switching condition A is not satisfied.					
	n.□□X□	Gain Switching Condition A		0	/COIN (Positioning Completion Output) signal turns ON.					
				1	/COIN (Positioning Completion Output) signal turns OFF.					
				2	/NEAR (Near Output) signal turns ON.					
				3	/NEAR (Near Output) signal turns OFF.					
				4	Position reference filter output is 0 and reference pulse input is OFF.					
				5	Position reference pulse input is ON.					
	n.□X□□	Reserved parameter (Do not change.)								
	n.X□□□	Reserved parameter (Do not change.)								
Pn13D	2	Current Gain Level	100 to 2,000	1%	2000	All	Immediately	Tuning	*1	
Pn13F	2	Less-Deviation Control 2 Second Position Integral Time Constant	0 to 50,000	0.1 ms	0	All	Immediately	Tuning	–	
Pn140	2	Model Following Control-Related Selections	0000 to 1121	–	0100	All	Immediately	Tuning	*1	
	n.□□□X	Model Following Control Selection		0	Do not use model following control.					
				1	Use model following control.					
	n.□□X□	Vibration Suppression Selection		0	Do not perform vibration suppression.					
				1	Perform vibration suppression for a specific frequency.					
				2	Perform vibration suppression for two specific frequencies.					
	n.□X□□	Vibration Suppression Adjustment Selection		0	Do not adjust vibration suppression automatically during execution of autotuning without a host reference, autotuning with a host reference, and custom tuning.					
				1	Adjust vibration suppression automatically during execution of autotuning without a host reference, autotuning with a host reference, and custom tuning.					
	n.X□□□	Speed Feedforward (VFF)/Torque Feedforward (TFF) Selection		0	Do not use model following control and speed/torque feedforward together.					
				1	Use model following control and speed/torque feedforward together.					
	Pn141	2	Model Following Control Gain	10 to 20,000	0.1/s	500	All	Immediately	Tuning	*1
	Pn142	2	Model Following Control Gain Correction	500 to 2,000	0.1%	1000	All	Immediately	Tuning	*1

Continued on next page.

5.1 SERVOPACKs with Analog Voltage/Pulse Train References

5.1.2 List of Parameters

Continued from previous page.

Parameter No.	Size	Name	Setting Range	Setting Unit	Default Setting	Applicable Motors	When Enabled	Classification	Reference	
Pn143	2	Model Following Control Bias in the Forward Direction	0 to 10,000	0.1%	1000	All	Immediately	Tuning	*1	
Pn144	2	Model Following Control Bias in the Reverse Direction	0 to 10,000	0.1%	1000	All	Immediately	Tuning	*1	
Pn145	2	Vibration Suppression 1 Frequency A	10 to 2,500	0.1 Hz	500	All	Immediately	Tuning	*1	
Pn146	2	Vibration Suppression 1 Frequency B	10 to 2,500	0.1 Hz	700	All	Immediately	Tuning	*1	
Pn147	2	Model Following Control Speed Feedforward Compensation	0 to 10,000	0.1%	1000	All	Immediately	Tuning	*1	
Pn148	2	Second Model Following Control Gain	10 to 20,000	0.1/s	500	All	Immediately	Tuning	*1	
Pn149	2	Second Model Following Control Gain Correction	500 to 2,000	0.1%	1000	All	Immediately	Tuning	*1	
Pn14A	2	Vibration Suppression 2 Frequency	10 to 2,000	0.1 Hz	800	All	Immediately	Tuning	*1	
Pn14B	2	Vibration Suppression 2 Correction	10 to 1,000	1%	100	All	Immediately	Tuning	*1	
Pn14F	2	Control-Related Selections	0000 to 0021	-	0021	All	After restart	Tuning	*1	
	n.□□□X		Model Following Control Type Selection							
			0	Use model following control type 1.						
			1	Use model following control type 2.						
	n.□□X□		Tuning-less Type Selection							
			0	Use tuning-less type 1.						
		1	Use tuning-less type 2.							
		2	Use tuning-less type 3.							
n.□X□□		Reserved parameter (Do not change.)								
n.X□□□		Reserved parameter (Do not change.)								
Pn160	2	Anti-Resonance Control-Related Selections	0000 to 0011	-	0010	All	Immediately	Tuning	*1	
	n.□□□X		Anti-Resonance Control Selection							
			0	Do not use anti-resonance control.						
			1	Use anti-resonance control.						
	n.□□X□		Anti-Resonance Control Adjustment Selection							
			0	Do not adjust anti-resonance control automatically during execution of autotuning without a host reference, autotuning with a host reference, and custom tuning.						
		1	Adjust anti-resonance control automatically during execution of autotuning without a host reference, autotuning with a host reference, and custom tuning.							
n.□X□□		Reserved parameter (Do not change.)								
n.X□□□		Reserved parameter (Do not change.)								
Pn161	2	Anti-Resonance Frequency	10 to 20,000	0.1 Hz	1000	All	Immediately	Tuning	*1	
Pn162	2	Anti-Resonance Gain Correction	1 to 1,000	1%	100	All	Immediately	Tuning	*1	

Continued on next page.

Continued from previous page.

Parameter No.	Size	Name	Setting Range	Setting Unit	Default Setting	Applicable Motors	When Enabled	Classification	Reference
Pn163	2	Anti-Resonance Damping Gain	0 to 300	1%	0	All	Immediately	Tuning	*1
Pn164	2	Anti-Resonance Filter Time Constant 1 Correction	-1,000 to 1,000	0.01 ms	0	All	Immediately	Tuning	*1
Pn165	2	Anti-Resonance Filter Time Constant 2 Correction	-1,000 to 1,000	0.01 ms	0	All	Immediately	Tuning	*1
Pn166	2	Anti-Resonance Damping Gain 2	0 to 1,000	1%	0	All	Immediately	Tuning	*1
Pn170	2	Tuning-less Function-Related Selections	0000 to 2711	–	1400	All	–	Setup	*1
	n.□□□X	Tuning-less Selection							When Enabled
		0	Disable tuning-less function.						After restart
	1	Enable tuning-less function.							
	n.□□X□	Speed Control Method							When Enabled
		0	Use for speed control.						After restart
	1	Use for speed control and use host controller for position control.							
	n.□X□□	Rigidity Level							When Enabled
		0 to 7	Set the rigidity level.						Immediately
	n.X□□□	Tuning-less Load Level							When Enabled
0 to 2		Set the load level for the tuning-less function.						Immediately	
Pn181	2	Mode Switching Level for Speed Reference	0 to 10,000	1 mm/s	0	Linear	Immediately	Tuning	*1
Pn182	2	Mode Switching Level for Acceleration	0 to 30,000	1 mm/s ²	0	Linear	Immediately	Tuning	*1
Pn190	2	Less-Deviation Control-Related Switches	0000 to 1101	–	0100	All	After restart	Setup	–
	n.□□□X	Less-Deviation Control Selection							
		0	Do not use less-deviation control.						
	1	Use less-deviation control.							
	n.□□X□	Reserved parameter (Do not change.)							
	n.□X□□	Reserved parameter (Do not change.)							
n.X□□□	Speed Feedforward/Torque Feedforward Selection								
	0	Less-deviation control and speed/torque feedforward are not used together.							
1	Less-deviation control and speed/torque feedforward are used together.								
Pn191	2	Less-Deviation Control 1 Feedforward Gain	0 to 10,000	0.1%	1000	All	Immediately	Tuning	–
Pn192	2	Less-Deviation Control 1 Second Feedforward Gain	0 to 10,000	0.1%	1000	All	Immediately	Tuning	–
Pn193	2	Less-Deviation Control 1 Feedforward Filter Time Constant	0 to 65,535	0.01 ms	30	All	Immediately	Tuning	–

Continued on next page.

5.1 SERVOPACKs with Analog Voltage/Pulse Train References

5.1.2 List of Parameters

Continued from previous page.

Parameter No.	Size	Name	Setting Range	Setting Unit	Default Setting	Applicable Motors	When Enabled	Classification	Reference
Pn195	2	Less-Deviation Function Selection Switches	0000 to 2113	–	2102	All	After restart	Setup	–
		n.□□□X	Reserved parameter (Do not change.)						
		n.□□X□	Reserved parameter (Do not change.)						
		n.□X□□	Reserved parameter (Do not change.)						
		n.X□□□	Less-Deviation Mode Selection						
		0	Use Less-Deviation Control 1 Mode when less-deviation control is enabled. (This mode is compatible with the Σ -V-series EX002.)						
		1	Reserved setting (Do not use.)						
		2	Use Less-Deviation Control 2 Mode when less-deviation control is enabled.						
Pn196	2	Less-Deviation Control 2 Speed Feedforward Gain	0 to 10,000	0.1%	1000	All	Immediately	Tuning	–
Pn197	2	Less-Deviation Control 2 Torque Feedforward Filter Time Constant	0 to 65,535	0.01 ms	50	All	Immediately	Tuning	–
Pn198	2	Less-Deviation Control 2 Forward Torque Feedforward Gain	0 to 10,000	0.1%	1000	All	Immediately	Tuning	–
Pn199	2	Less-Deviation Control 2 Reverse Torque Feedforward Gain	0 to 10,000	0.1%	1000	All	Immediately	Tuning	–
Pn19A	2	Less-Deviation Control 2 Incomplete Integration Rate	0 to 10,000	0.01%	10000	All	Immediately	Tuning	–
Pn19B	2	Less-Deviation Control 2 Rotary Servomotor Viscous Friction Compensation Coefficient	0 to 8,000	0.01%/100 min ⁻¹	0	Rotary	Immediately	Tuning	–
Pn19C	2	Reserved parameter (Do not change.)	–	–	0	All	Immediately	Tuning	–
Pn19D	2	Less-Deviation Control 2 Linear Servomotor Viscous Friction Compensation Coefficient	0 to 8,000	0.01%/100 mm/s	0	Linear	Immediately	Tuning	–
Pn19E	2	Reserved parameter (Do not change.)	–	–	0	All	Immediately	Tuning	–
Pn19F	2	Less-Deviation Control 2 Torque Feedforward Moving Average Time	0 to 5,100	0.1 ms	0	All	Immediately	Tuning	–
Pn1A4	2	Reserved parameter (Do not change.)	–	–	36	–	Immediately	Tuning	–
Pn1A5	2	Reserved parameter (Do not change.)	–	–	0	–	Immediately	Tuning	–
Pn1AE	2	Reserved parameter (Do not change.)	–	–	0	–	Immediately	Tuning	–
Pn1AF	2	Reserved parameter (Do not change.)	–	–	0	–	Immediately	Tuning	–

Continued on next page.

Continued from previous page.

Parameter No.	Size	Name	Setting Range	Setting Unit	Default Setting	Applicable Motors	When Enabled	Classification	Reference																																											
Pn200	2	Position Control Reference For Selections	0000 to 2236	-	0000	All	After restart	Setup	*1																																											
			<table border="1"> <thead> <tr> <th colspan="2">Reference Pulse Form</th> </tr> </thead> <tbody> <tr> <td>0</td> <td>Sign and pulse train, positive logic.</td> </tr> <tr> <td>1</td> <td>CW and CCW pulse trains, positive logic</td> </tr> <tr> <td>2</td> <td>Two-phase pulse trains with 90° phase differential (phase A and phase B) x1, positive logic</td> </tr> <tr> <td>3</td> <td>Two-phase pulse trains with 90° phase differential (phase A and phase B) x2, positive logic</td> </tr> <tr> <td>4</td> <td>Two-phase pulse trains with 90° phase differential (phase A and phase B) x4, positive logic</td> </tr> <tr> <td>5</td> <td>Sign and pulse train, negative logic.</td> </tr> <tr> <td>6</td> <td>CW and CCW pulse trains, negative logic</td> </tr> </tbody> </table> <table border="1"> <thead> <tr> <th colspan="2">Clear Signal Form</th> </tr> </thead> <tbody> <tr> <td>0</td> <td>Clear position deviation when the signal is at high level.</td> </tr> <tr> <td>1</td> <td>Clear position deviation on the rising edge of the signal.</td> </tr> <tr> <td>2</td> <td>Clear position deviation when the signal is at low level.</td> </tr> <tr> <td>3</td> <td>Clear position deviation on the falling edge of the signal.</td> </tr> </tbody> </table> <table border="1"> <thead> <tr> <th colspan="2">Clear Operation</th> </tr> </thead> <tbody> <tr> <td>0</td> <td>Clear position deviation at a base block (at servo OFF or when alarm occurs).</td> </tr> <tr> <td>1</td> <td>Do not clear position error (cleared only with CLR (Clear Position Deviation) signal).</td> </tr> <tr> <td>2</td> <td>Clear position deviation when an alarm occurs.</td> </tr> </tbody> </table> <table border="1"> <thead> <tr> <th colspan="2">Filter Selection</th> </tr> </thead> <tbody> <tr> <td>0</td> <td>Use the reference input filter for a line-driver signal. (1 Mpps max.)</td> </tr> <tr> <td>1</td> <td>Use the reference input filter for an open-collector signal. (200 kpps max.)</td> </tr> <tr> <td>2</td> <td>Use reference input filter 2 for a line-driver signal. (1 to 4 Mpps)</td> </tr> </tbody> </table>								Reference Pulse Form		0	Sign and pulse train, positive logic.	1	CW and CCW pulse trains, positive logic	2	Two-phase pulse trains with 90° phase differential (phase A and phase B) x1, positive logic	3	Two-phase pulse trains with 90° phase differential (phase A and phase B) x2, positive logic	4	Two-phase pulse trains with 90° phase differential (phase A and phase B) x4, positive logic	5	Sign and pulse train, negative logic.	6	CW and CCW pulse trains, negative logic	Clear Signal Form		0	Clear position deviation when the signal is at high level.	1	Clear position deviation on the rising edge of the signal.	2	Clear position deviation when the signal is at low level.	3	Clear position deviation on the falling edge of the signal.	Clear Operation		0	Clear position deviation at a base block (at servo OFF or when alarm occurs).	1	Do not clear position error (cleared only with CLR (Clear Position Deviation) signal).	2	Clear position deviation when an alarm occurs.	Filter Selection		0	Use the reference input filter for a line-driver signal. (1 Mpps max.)	1	Use the reference input filter for an open-collector signal. (200 kpps max.)	2	Use reference input filter 2 for a line-driver signal. (1 to 4 Mpps)
	Reference Pulse Form																																																			
	0	Sign and pulse train, positive logic.																																																		
	1	CW and CCW pulse trains, positive logic																																																		
	2	Two-phase pulse trains with 90° phase differential (phase A and phase B) x1, positive logic																																																		
	3	Two-phase pulse trains with 90° phase differential (phase A and phase B) x2, positive logic																																																		
	4	Two-phase pulse trains with 90° phase differential (phase A and phase B) x4, positive logic																																																		
	5	Sign and pulse train, negative logic.																																																		
	6	CW and CCW pulse trains, negative logic																																																		
	Clear Signal Form																																																			
	0	Clear position deviation when the signal is at high level.																																																		
	1	Clear position deviation on the rising edge of the signal.																																																		
	2	Clear position deviation when the signal is at low level.																																																		
	3	Clear position deviation on the falling edge of the signal.																																																		
	Clear Operation																																																			
	0	Clear position deviation at a base block (at servo OFF or when alarm occurs).																																																		
	1	Do not clear position error (cleared only with CLR (Clear Position Deviation) signal).																																																		
	2	Clear position deviation when an alarm occurs.																																																		
	Filter Selection																																																			
0	Use the reference input filter for a line-driver signal. (1 Mpps max.)																																																			
1	Use the reference input filter for an open-collector signal. (200 kpps max.)																																																			
2	Use reference input filter 2 for a line-driver signal. (1 to 4 Mpps)																																																			
Pn205	2	Multiturn Limit	0 to 65,535	1 rev	65535	Rotary	After restart	Setup	*1																																											
Pn207	2	Position Control Function Selections	0000 to 2210	-	1000	All	After restart	Setup	*1																																											
	n.□□□X		Reserved parameter (Do not change.)																																																	
	n.□□X□		Reserved parameter (Do not change.)																																																	
	n.□X□□		Reserved parameter (Do not change.)																																																	
			<table border="1"> <thead> <tr> <th colspan="2">/COIN (Positioning Completion Output) Signal Output Timing</th> </tr> </thead> <tbody> <tr> <td>0</td> <td>Output when the absolute value of the position deviation is the same or less than the setting of Pn522 (Positioning Completed Width).</td> </tr> <tr> <td>1</td> <td>Output when the absolute value of the position error is the same or less than the setting of Pn522 (Positioning Completed Width) and the reference after the position reference filter is 0.</td> </tr> <tr> <td>2</td> <td>Output when the absolute value of the position error is the same or less than the setting of Pn522 (Positioning Completed Width) and the reference input is 0.</td> </tr> </tbody> </table>								/COIN (Positioning Completion Output) Signal Output Timing		0	Output when the absolute value of the position deviation is the same or less than the setting of Pn522 (Positioning Completed Width).	1	Output when the absolute value of the position error is the same or less than the setting of Pn522 (Positioning Completed Width) and the reference after the position reference filter is 0.	2	Output when the absolute value of the position error is the same or less than the setting of Pn522 (Positioning Completed Width) and the reference input is 0.																																		
	/COIN (Positioning Completion Output) Signal Output Timing																																																			
0	Output when the absolute value of the position deviation is the same or less than the setting of Pn522 (Positioning Completed Width).																																																			
1	Output when the absolute value of the position error is the same or less than the setting of Pn522 (Positioning Completed Width) and the reference after the position reference filter is 0.																																																			
2	Output when the absolute value of the position error is the same or less than the setting of Pn522 (Positioning Completed Width) and the reference input is 0.																																																			
n.X□□□																																																				
Pn20A	4	Number of External Encoder Scale Pitches	4 to 1,048,576	1 scale pitch/revolution	32768	Rotary	After restart	Setup	*1																																											
Pn20E	4	Electronic Gear Ratio (Numerator)	1 to 1,073,741,824	1	64	All	After restart	Setup	*1																																											

Continued on next page.

5.1 SERVOPACKs with Analog Voltage/Pulse Train References

5.1.2 List of Parameters

Continued from previous page.

Parameter No.	Size	Name	Setting Range	Setting Unit	Default Setting	Applicable Motors	When Enabled	Classification	Reference
Pn210	4	Electronic Gear Ratio (Denominator)	1 to 1,073,741,824	1	1	All	After restart	Setup	*1
Pn212	4	Number of Encoder Output Pulses	16 to 1,073,741,824	1 P/Rev	2048	Rotary	After restart	Setup	*1
Pn216	2	Position Reference Acceleration/Deceleration Time Constant	0 to 65,535	0.1 ms	0	All	Immediately after the motor stops	Setup	*1
Pn217	2	Average Position Reference Movement Time	0 to 10,000	0.1 ms	0	All	Immediately after the motor stops	Setup	*1
Pn218	2	Reference Pulse Input Multiplier	1 to 100	× 1	1	All	Immediately	Setup	*1
Pn22A	2	Fully-closed Control Selections	0000 to 1003	–	0000	Rotary	After restart	Setup	*1
	n.□□□X		Reserved parameter (Do not change.)						
	n.□□X□		Reserved parameter (Do not change.)						
	n.□X□□		Reserved parameter (Do not change.)						
	n.X□□□		Fully-closed Control Speed Feedback Selection						
		0	Use motor encoder speed.						
		1	Use external encoder speed.						
Pn234	2	Second Position Reference Acceleration/Deceleration Time Constant	0 to 65,535	0.1 ms	0	All	Immediately	Setup	–
Pn281	2	Encoder Output Resolution	1 to 4,096	1 edge/pitch	20	All	After restart	Setup	*1
Pn282	4	Linear Encoder Scale Pitch	0 to 6,553,600	0.01 μm	0	Linear	After restart	Setup	*1
Pn300	2	Speed Reference Input Gain	150 to 3,000	0.01 V/Rated motor speed	600	All	Immediately	Setup	*1
Pn301	2	Internal Set Speed 1	0 to 10,000	Rotary: 1 min ⁻¹ Direct Drive: 0.1 min ⁻¹	100	Rotary	Immediately	Setup	*1
Pn302	2	Internal Set Speed 2	0 to 10,000	Rotary: 1 min ⁻¹ Direct Drive: 0.1 min ⁻¹	200	Rotary	Immediately	Setup	*1
Pn303	2	Internal Set Speed 3	0 to 10,000	Rotary: 1 min ⁻¹ Direct Drive: 0.1 min ⁻¹	300	Rotary	Immediately	Setup	*1
Pn304	2	Jogging Speed	0 to 10,000	Rotary: 1 min ⁻¹ Direct Drive: 0.1 min ⁻¹	500	Rotary	Immediately	Setup	*1
Pn305	2	Soft Start Acceleration Time	0 to 10,000	1 ms	0	All	Immediately	Setup	*1
Pn306	2	Soft Start Deceleration Time	0 to 10,000	1 ms	0	All	Immediately	Setup	*1

Continued on next page.

Continued from previous page.

Parameter No.	Size	Name	Setting Range	Setting Unit	Default Setting	Applicable Motors	When Enabled	Classification	Reference												
Pn307	2	Speed Reference Filter Time Constant	0 to 65,535	0.01 ms	40	All	Immediately	Setup	*1												
Pn308	2	Speed Feedback Filter Time Constant	0 to 65,535	0.01 ms	0	All	Immediately	Setup	*1												
Pn30A	2	Deceleration Time for Servo OFF and Forced Stops	0 to 10,000	1 ms	0	All	Immediately	Setup	*1												
Pn30C	2	Speed Feedforward Average Movement Time	0 to 5,100	0.1 ms	0	All	Immediately	Setup	*1												
Pn310	2	Vibration Detection Selections	0000 to 0002	–	0000	All	Immediately	Setup	*1												
		<table border="1"> <thead> <tr> <th colspan="2">Vibration Detection Selection</th> </tr> </thead> <tbody> <tr> <td>n.0000</td> <td>0</td> <td>Do not detect vibration.</td> </tr> <tr> <td>n.0001</td> <td>1</td> <td>Output a warning (A.911) if vibration is detected.</td> </tr> <tr> <td>n.0002</td> <td>2</td> <td>Output an alarm (A.520) if vibration is detected.</td> </tr> </tbody> </table>									Vibration Detection Selection		n.0000	0	Do not detect vibration.	n.0001	1	Output a warning (A.911) if vibration is detected.	n.0002	2	Output an alarm (A.520) if vibration is detected.
		Vibration Detection Selection																			
		n.0000	0	Do not detect vibration.																	
		n.0001	1	Output a warning (A.911) if vibration is detected.																	
		n.0002	2	Output an alarm (A.520) if vibration is detected.																	
n.00X0	Reserved parameter (Do not change.)																				
n.0X00	Reserved parameter (Do not change.)																				
n.X000	Reserved parameter (Do not change.)																				
Pn311	2	Vibration Detection Sensitivity	50 to 500	1%	100	All	Immediately	Tuning	*1												
Pn312	2	Vibration Detection Level	0 to 5,000	1 min ⁻¹	50	Rotary	Immediately	Tuning	*1												
Pn316	2	Maximum Motor Speed	0 to 65,535	1 min ⁻¹	10000	Rotary	After restart	Setup	*1												
Pn324	2	Moment of Inertia Calculation Starting Level	0 to 20,000	1%	300	All	Immediately	Setup	*1												
Pn380	2	Internal Set Speed 1	0 to 10,000	1 mm/s	10	Linear	Immediately	Setup	*1												
Pn381	2	Internal Set Speed 2	0 to 10,000	1 mm/s	20	Linear	Immediately	Setup	*1												
Pn382	2	Internal Set Speed 3	0 to 10,000	1 mm/s	30	Linear	Immediately	Setup	*1												
Pn383	2	Jogging Speed	0 to 10,000	1 mm/s	50	Linear	Immediately	Setup	*1												
Pn384	2	Vibration Detection Level	0 to 5,000	1 mm/s	10	Linear	Immediately	Tuning	*1												
Pn385	2	Maximum Motor Speed	1 to 100	100 mm/s	50	Linear	After restart	Setup	*1												
Pn400	2	Torque Reference Input Gain	10 to 100	0.1 V/rated torque	30	All	Immediately	Setup	*1												
Pn401	2	First Stage First Torque Reference Filter Time Constant	0 to 65,535	0.01 ms	100	All	Immediately	Tuning	*1												
Pn402	2	Forward Torque Limit	0 to 800	1%*2	800	Rotary	Immediately	Setup	*1												
Pn403	2	Reverse Torque Limit	0 to 800	1%*2	800	Rotary	Immediately	Setup	*1												
Pn404	2	Forward External Torque Limit	0 to 800	1%*2	100	All	Immediately	Setup	*1												
Pn405	2	Reverse External Torque Limit	0 to 800	1%*2	100	All	Immediately	Setup	*1												
Pn406	2	Emergency Stop Torque	0 to 800	1%*2	800	All	Immediately	Setup	*1												
Pn407	2	Speed Limit during Torque Control	0 to 10,000	1 min ⁻¹	10000	Rotary	Immediately	Setup	*1												

Continued on next page.

5.1 SERVOPACKs with Analog Voltage/Pulse Train References

5.1.2 List of Parameters

Continued from previous page.

Parameter No.	Size	Name	Setting Range	Setting Unit	Default Setting	Applicable Motors	When Enabled	Classification	Reference	
Pn408	2	Torque-Related Function Selections	0000 to 1111	–	0000	All	–	Setup	*1	
	n.□□□X		Notch Filter Selection 1						When Enabled	
			0	Disable first stage notch filter.					Immediately	
			1	Enable first stage notch filter.						
	n.□□X□		Speed Limit Selection						When Enabled	
			0	Use the smaller of the maximum motor speed and the setting of Pn407 as the speed limit.					After restart	
				Use the smaller of the maximum motor speed and the setting of Pn480 as the speed limit.						
			1	Use the smaller of the overspeed alarm detection speed and the setting of Pn407 as the speed limit.						
				Use the smaller of the overspeed alarm detection speed and the setting of Pn480 as the speed limit.						
	n.□X□□		Notch Filter Selection 2						When Enabled	
			0	Disable second stage notch filter.					Immediately	
			1	Enable second stage notch filter.						
	n.X□□□		Friction Compensation Function Selection						When Enabled	
			0	Disable friction compensation.					Immediately	
			1	Enable friction compensation.						
Pn409	2	First Stage Notch Filter Frequency	50 to 5,000	1 Hz	5000	All	Immediately	Tuning	*1	
Pn40A	2	First Stage Notch Filter Q Value	50 to 1,000	0.01	70	All	Immediately	Tuning	*1	
Pn40B	2	First Stage Notch Filter Depth	0 to 1,000	0.001	0	All	Immediately	Tuning	*1	
Pn40C	2	Second Stage Notch Filter Frequency	50 to 5,000	1 Hz	5000	All	Immediately	Tuning	*1	
Pn40D	2	Second Stage Notch Filter Q Value	50 to 1,000	0.01	70	All	Immediately	Tuning	*1	
Pn40E	2	Second Stage Notch Filter Depth	0 to 1,000	0.001	0	All	Immediately	Tuning	*1	
Pn40F	2	Second Stage Second Torque Reference Filter Frequency	100 to 5,000	1 Hz	5000	All	Immediately	Tuning	*1	
Pn410	2	Second Stage Second Notch Filter Q Value	50 to 100	0.01	50	All	Immediately	Tuning	*1	
Pn412	2	First Stage Second Torque Reference Filter Time Constant	0 to 65,535	0.01 ms	100	All	Immediately	Tuning	*1	
Pn415	2	T-REF Filter Time Constant	0 to 65,535	0.01 ms	0	All	Immediately	Setup	*1	

Continued on next page.

Continued from previous page.

Parameter No.	Size	Name	Setting Range	Setting Unit	Default Setting	Applicable Motors	When Enabled	Classification	Reference
Pn416	2	Torque-Related Function Selections 2	0000 to 1111	–	0000	All	Immediately	Setup	*1
	n.□□□X	Notch Filter Selection 3							
		0	Disable third stage notch filter.						
	n.□□X□	Notch Filter Selection 4							
		0	Disable fourth stage notch filter.						
	n.□X□□	Notch Filter Selection 5							
		0	Disable fifth stage notch filter.						
	n.X□□□	Reserved parameter (Do not change.)							
		2	Third Stage Notch Filter Frequency	50 to 5,000	1 Hz	5000	All	Immediately	Tuning
	Pn418	2	Third Stage Notch Filter Q Value	50 to 1,000	0.01	70	All	Immediately	Tuning
Pn419	2	Third Stage Notch Filter Depth	0 to 1,000	0.001	0	All	Immediately	Tuning	*1
Pn41A	2	Fourth Stage Notch Filter Frequency	50 to 5,000	1 Hz	5000	All	Immediately	Tuning	*1
Pn41B	2	Fourth Stage Notch Filter Q Value	50 to 1,000	0.01	70	All	Immediately	Tuning	*1
Pn41C	2	Fourth Stage Notch Filter Depth	0 to 1,000	0.001	0	All	Immediately	Tuning	*1
Pn41D	2	Fifth Stage Notch Filter Frequency	50 to 5,000	1 Hz	5000	All	Immediately	Tuning	*1
Pn41E	2	Fifth Stage Notch Filter Q Value	50 to 1,000	0.01	70	All	Immediately	Tuning	*1
Pn41F	2	Fifth Stage Notch Filter Depth	0 to 1,000	0.001	0	All	Immediately	Tuning	*1
Pn423	2	Speed Ripple Compensation Selections	0000 to 1111	–	0000	Rotary	–	Setup	*1
	n.□□□X	Speed Ripple Compensation Function Selection						When Enabled	
		0	Disable speed ripple compensation.						Immediately
	n.□□X□	Speed Ripple Compensation Information Disagreement Warning Detection Selection						When Enabled	
		0	Detect A.942 alarms.						After restart
	n.□X□□	Speed Ripple Compensation Enable Condition Selection						When Enabled	
0		Speed reference						After restart	
n.X□□□	Reserved parameter (Do not change.)								
	Pn424	2	Torque Limit at Main Circuit Voltage Drop	0 to 100	1%*2	50	All	Immediately	Setup

Continued on next page.

5.1 SERVOPACKs with Analog Voltage/Pulse Train References

5.1.2 List of Parameters

Continued from previous page.

Parameter No.	Size	Name	Setting Range	Setting Unit	Default Setting	Applicable Motors	When Enabled	Classification	Reference	
Pn425	2	Release Time for Torque Limit at Main Circuit Voltage Drop	0 to 1,000	1 ms	100	All	Immediately	Setup	*1	
Pn426	2	Torque Feedforward Average Movement Time	0 to 5,100	0.1 ms	0	All	Immediately	Setup	*1	
Pn427	2	Speed Ripple Compensation Enable Speed	0 to 10,000	1 min ⁻¹	0	Rotary Servomotor	Immediately	Tuning	*1	
Pn456	2	Sweep Torque Reference Amplitude	1 to 800	1%	15	All	Immediately	Tuning	*1	
Pn460	2	Notch Filter Adjustment Selections 1		0000 to 0101	–	0101	All	Immediately	Tuning	*1
		n.□□□X	Notch Filter Adjustment Selection 1							
			0	Do not adjust the first stage notch filter automatically during execution of autotuning without a host reference, autotuning with a host reference, and custom tuning.						
		1	Adjust the first stage notch filter automatically during execution of autotuning without a host reference, autotuning with a host reference, and custom tuning.							
		n.□□X□	Reserved parameter (Do not change.)							
		n.□X□□	Notch Filter Adjustment Selection 2							
0	Do not adjust the second stage notch filter automatically during execution of autotuning without a host reference, autotuning with a host reference, and custom tuning.									
1	Adjust the second stage notch filter automatically during execution of autotuning without a host reference, autotuning with a host reference, and custom tuning.									
n.X□□□	Reserved parameter (Do not change.)									
Pn480	2	Speed Limit during Force Control	0 to 10,000	1 mm/s	10000	Linear	Immediately	Setup	*1	
Pn481	2	Polarity Detection Speed Loop Gain	10 to 20,000	0.1 Hz	400	Linear	Immediately	Tuning	–	
Pn482	2	Polarity Detection Speed Loop Integral Time Constant	15 to 51,200	0.01 ms	3000	Linear	Immediately	Tuning	–	
Pn483	2	Forward Force Limit	0 to 800	1%*2	30	Linear	Immediately	Setup	*1	
Pn484	2	Reverse Force Limit	0 to 800	1%*2	30	Linear	Immediately	Setup	*1	
Pn485	2	Polarity Detection Reference Speed	0 to 100	1 mm/s	20	Linear	Immediately	Tuning	–	
Pn486	2	Polarity Detection Reference Acceleration/Deceleration Time	0 to 100	1 ms	25	Linear	Immediately	Tuning	–	
Pn487	2	Polarity Detection Constant Speed Time	0 to 300	1 ms	0	Linear	Immediately	Tuning	–	
Pn488	2	Polarity Detection Reference Waiting Time	50 to 500	1 ms	100	Linear	Immediately	Tuning	–	
Pn48E	2	Polarity Detection Range	1 to 65,535	1 mm	10	Linear	Immediately	Tuning	–	
Pn490	2	Polarity Detection Load Level	0 to 20,000	1%	100	Linear	Immediately	Tuning	–	
Pn495	2	Polarity Detection Confirmation Force Reference	0 to 200	1%	100	Linear	Immediately	Tuning	–	
Pn498	2	Polarity Detection Allowable Error Range	0 to 30	1 deg	10	Linear	Immediately	Tuning	–	
Pn49F	2	Speed Ripple Compensation Enable Speed	0 to 10,000	1 mm/s	0	Linear	Immediately	Tuning	*1	

Continued on next page.

Continued from previous page.

Parameter No.	Size	Name	Setting Range	Setting Unit	Default Setting	Applicable Motors	When Enabled	Classification	Reference
Pn501	2	Zero Clamping Level	0 to 10,000	1 min ⁻¹	10	Rotary	Immediately	Setup	*1
Pn502	2	Rotation Detection Level	1 to 10,000	1 min ⁻¹	20	Rotary	Immediately	Setup	*1
Pn503	2	Speed Coincidence Detection Signal Output Width	0 to 100	1 min ⁻¹	10	Rotary	Immediately	Setup	*1
Pn506	2	Brake Reference-Servo OFF Delay Time	0 to 50	10 ms	0	All	Immediately	Setup	*1
Pn507	2	Brake Reference Output Speed Level	0 to 10,000	1 min ⁻¹	100	Rotary	Immediately	Setup	*1
Pn508	2	Servo OFF-Brake Command Waiting Time	10 to 100	10 ms	50	All	Immediately	Setup	*1
Pn509	2	Momentary Power Interruption Hold Time	20 to 50,000	1 ms	20	All	Immediately	Setup	*1

Continued on next page.

5.1 SERVOPACKs with Analog Voltage/Pulse Train References

5.1.2 List of Parameters

Continued from previous page.

Parameter No.	Size	Name	Setting Range	Setting Unit	Default Setting	Applicable Motors	When Enabled	Classification	Reference	
Pn50A	2	Input Signal Selections 1	0000 to FFF2	-	2100	All	After restart	Setup	*1	
	n.□□□X		Input Signal Allocation Mode							
			0	Use the sequence input signal terminals with the default allocations.						
			1	Change the sequence input signal allocations.						
			2	Reserved setting (Do not use.)						
	n.□□X□		/S-ON (Servo ON) Signal Allocation							
			0	Active when CN1-40 input signal is ON (closed).						
			1	Active when CN1-41 input signal is ON (closed).						
			2	Active when CN1-42 input signal is ON (closed).						
			3	Active when CN1-43 input signal is ON (closed).						
			4	Active when CN1-44 input signal is ON (closed).						
			5	Active when CN1-45 input signal is ON (closed).						
			6	Active when CN1-46 input signal is ON (closed).						
			7	The signal is always active.						
			8	The signal is always inactive.						
			9	Active when CN1-40 input signal is OFF (open).						
			A	Active when CN1-41 input signal is OFF (open).						
			B	Active when CN1-42 input signal is OFF (open).						
			C	Active when CN1-43 input signal is OFF (open).						
			D	Active when CN1-44 input signal is OFF (open).						
			E	Active when CN1-45 input signal is OFF (open).						
			F	Active when CN1-46 input signal is OFF (open).						
	n.□X□□		/P-CON (Proportional Control) Signal Allocation							
			0 to F	The allocations are the same as the /S-ON (Servo ON) signal allocations.						
	n.X□□□		P-OT (Forward Drive Prohibit) Signal Allocation							
			0	Enable forward drive when CN1-40 input signal is ON (closed).						
			1	Enable forward drive when CN1-41 input signal is ON (closed).						
			2	Enable forward drive when CN1-42 input signal is ON (closed).						
			3	Enable forward drive when CN1-43 input signal is ON (closed).						
			4	Enable forward drive when CN1-44 input signal is ON (closed).						
			5	Enable forward drive when CN1-45 input signal is ON (closed).						
			6	Enable forward drive when CN1-46 input signal is ON (closed).						
			7	Set the signal to always prohibit forward drive.						
			8	Set the signal to always enable forward drive.						
			9	Enable forward drive when CN1-40 input signal is OFF (open).						
			A	Enable forward drive when CN1-41 input signal is OFF (open).						
			B	Enable forward drive when CN1-42 input signal is OFF (open).						
			C	Enable forward drive when CN1-43 input signal is OFF (open).						
			D	Enable forward drive when CN1-44 input signal is OFF (open).						
			E	Enable forward drive when CN1-45 input signal is OFF (open).						
			F	Enable forward drive when CN1-46 input signal is OFF (open).						

Continued on next page.

Continued from previous page.

Parameter No.	Size	Name	Setting Range	Setting Unit	Default Setting	Applicable Motors	When Enabled	Classification	Reference	
Pn50B	2	Input Signal Selections ²	0000 to FFFF	–	6543	All	After restart	Setup	*1	
	N-OT (Reverse Drive Prohibit) Signal Allocation									
	n.□□□X		0	Enable reverse drive when CN1-40 input signal is ON (closed).						
	n.□□□X		1	Enable reverse drive when CN1-41 input signal is ON (closed).						
	n.□□□X		2	Enable reverse drive when CN1-42 input signal is ON (closed).						
	n.□□□X		3	Enable reverse drive when CN1-43 input signal is ON (closed).						
	n.□□□X		4	Enable reverse drive when CN1-44 input signal is ON (closed).						
	n.□□□X		5	Enable reverse drive when CN1-45 input signal is ON (closed).						
	n.□□□X		6	Enable reverse drive when CN1-46 input signal is ON (closed).						
	n.□□□X		7	Set the signal to always prohibit reverse drive.						
	n.□□□X		8	Set the signal to always enable reverse drive.						
	n.□□□X		9	Enable reverse drive when CN1-40 input signal is OFF (open).						
	n.□□□X		A	Enable reverse drive when CN1-41 input signal is OFF (open).						
	n.□□□X		B	Enable reverse drive when CN1-42 input signal is OFF (open).						
	n.□□□X		C	Enable reverse drive when CN1-43 input signal is OFF (open).						
	n.□□□X		D	Enable reverse drive when CN1-44 input signal is OFF (open).						
	n.□□□X		E	Enable reverse drive when CN1-45 input signal is OFF (open).						
	n.□□□X		F	Enable reverse drive when CN1-46 input signal is OFF (open).						
	/ALM-RST (Alarm Reset) Signal Allocation									
	n.□□X□		0	Active on signal edge when CN1-40 input signal changes from OFF (open) to ON (closed).						
	n.□□X□		1	Active on signal edge when CN1-41 input signal changes from OFF (open) to ON (closed).						
	n.□□X□		2	Active on signal edge when CN1-42 input signal changes from OFF (open) to ON (closed).						
	n.□□X□		3	Active on signal edge when CN1-43 input signal changes from OFF (open) to ON (closed).						
	n.□□X□		4	Active on signal edge when CN1-44 input signal changes from OFF (open) to ON (closed).						
	n.□□X□		5	Active on signal edge when CN1-45 input signal changes from OFF (open) to ON (closed).						
	n.□□X□		6	Active on signal edge when CN1-46 input signal changes from OFF (open) to ON (closed).						
	n.□□X□		7	Reserved setting (Do not use.)						
	n.□□X□		8	The signal is always inactive.						
	n.□□X□		9	Active on signal edge when CN1-40 input signal changes from ON (closed) to OFF (open).						
	n.□□X□		A	Active on signal edge when CN1-41 input signal changes from ON (closed) to OFF (open).						
	n.□□X□		B	Active on signal edge when CN1-42 input signal changes from ON (closed) to OFF (open).						
	n.□□X□		C	Active on signal edge when CN1-43 input signal changes from ON (closed) to OFF (open).						
	n.□□X□		D	Active on signal edge when CN1-44 input signal changes from ON (closed) to OFF (open).						
	n.□□X□		E	Active on signal edge when CN1-45 input signal changes from ON (closed) to OFF (open).						
	n.□□X□		F	Active on signal edge when CN1-46 input signal changes from ON (closed) to OFF (open).						
	/P-CL (Forward External Torque Limit Input) Signal Allocation									
	n.□X□□		0 to F	The allocations are the same as the /S-ON (Servo ON) signal allocations.						
	/N-CL (Reverse External Torque Limit Input) Signal Allocation									
	n.X□□□		0 to F	The allocations are the same as the /S-ON (Servo ON) signal allocations.						

Continued on next page.

5.1 SERVOPACKs with Analog Voltage/Pulse Train References

5.1.2 List of Parameters

Continued from previous page.

Parameter No.	Size	Name	Setting Range	Setting Unit	Default Setting	Applicable Motors	When Enabled	Classification	Reference																																														
Pn50C	2	Input Signal Selections	0000 to FFFF	–	8888	All	After restart	Setup	*1																																														
	3	<table border="1"> <thead> <tr> <th colspan="2">/SPD-D (Motor Direction) Signal Allocation</th> </tr> </thead> <tbody> <tr><td>0</td><td>Active when CN1-40 input signal is ON (closed).</td></tr> <tr><td>1</td><td>Active when CN1-41 input signal is ON (closed).</td></tr> <tr><td>2</td><td>Active when CN1-42 input signal is ON (closed).</td></tr> <tr><td>3</td><td>Active when CN1-43 input signal is ON (closed).</td></tr> <tr><td>4</td><td>Active when CN1-44 input signal is ON (closed).</td></tr> <tr><td>5</td><td>Active when CN1-45 input signal is ON (closed).</td></tr> <tr><td>6</td><td>Active when CN1-46 input signal is ON (closed).</td></tr> <tr><td>n.□□□X</td><td>7 The signal is always active.</td></tr> <tr><td></td><td>8 The signal is always inactive.</td></tr> <tr><td></td><td>9 Active when CN1-40 input signal is OFF (open).</td></tr> <tr><td>A</td><td>Active when CN1-41 input signal is OFF (open).</td></tr> <tr><td>B</td><td>Active when CN1-42 input signal is OFF (open).</td></tr> <tr><td>C</td><td>Active when CN1-43 input signal is OFF (open).</td></tr> <tr><td>D</td><td>Active when CN1-44 input signal is OFF (open).</td></tr> <tr><td>E</td><td>Active when CN1-45 input signal is OFF (open).</td></tr> <tr><td>F</td><td>Active when CN1-46 input signal is OFF (open).</td></tr> </tbody> </table> <table border="1"> <thead> <tr> <th colspan="2">/SPD-A (Internal Set Speed Selection Input) Signal Allocation</th> </tr> </thead> <tbody> <tr> <td>n.□□X□</td> <td>0 to F The allocations are the same as the /SPD-D (Motor Direction) signal allocations.</td> </tr> </tbody> </table> <table border="1"> <thead> <tr> <th colspan="2">/SPD-B (Internal Set Speed Selection Input) Signal Allocation</th> </tr> </thead> <tbody> <tr> <td>n.□X□□</td> <td>0 to F The allocations are the same as the /SPD-D (Motor Direction) signal allocations.</td> </tr> </tbody> </table> <table border="1"> <thead> <tr> <th colspan="2">/C-SEL (Control Selection Input) Signal Allocation</th> </tr> </thead> <tbody> <tr> <td>n.X□□□</td> <td>0 to F The allocations are the same as the /SPD-D (Motor Direction) signal allocations.</td> </tr> </tbody> </table>								/SPD-D (Motor Direction) Signal Allocation		0	Active when CN1-40 input signal is ON (closed).	1	Active when CN1-41 input signal is ON (closed).	2	Active when CN1-42 input signal is ON (closed).	3	Active when CN1-43 input signal is ON (closed).	4	Active when CN1-44 input signal is ON (closed).	5	Active when CN1-45 input signal is ON (closed).	6	Active when CN1-46 input signal is ON (closed).	n.□□□X	7 The signal is always active.		8 The signal is always inactive.		9 Active when CN1-40 input signal is OFF (open).	A	Active when CN1-41 input signal is OFF (open).	B	Active when CN1-42 input signal is OFF (open).	C	Active when CN1-43 input signal is OFF (open).	D	Active when CN1-44 input signal is OFF (open).	E	Active when CN1-45 input signal is OFF (open).	F	Active when CN1-46 input signal is OFF (open).	/SPD-A (Internal Set Speed Selection Input) Signal Allocation		n.□□X□	0 to F The allocations are the same as the /SPD-D (Motor Direction) signal allocations.	/SPD-B (Internal Set Speed Selection Input) Signal Allocation		n.□X□□	0 to F The allocations are the same as the /SPD-D (Motor Direction) signal allocations.	/C-SEL (Control Selection Input) Signal Allocation		n.X□□□	0 to F The allocations are the same as the /SPD-D (Motor Direction) signal allocations.
	/SPD-D (Motor Direction) Signal Allocation																																																						
	0	Active when CN1-40 input signal is ON (closed).																																																					
	1	Active when CN1-41 input signal is ON (closed).																																																					
	2	Active when CN1-42 input signal is ON (closed).																																																					
	3	Active when CN1-43 input signal is ON (closed).																																																					
	4	Active when CN1-44 input signal is ON (closed).																																																					
	5	Active when CN1-45 input signal is ON (closed).																																																					
	6	Active when CN1-46 input signal is ON (closed).																																																					
	n.□□□X	7 The signal is always active.																																																					
		8 The signal is always inactive.																																																					
		9 Active when CN1-40 input signal is OFF (open).																																																					
	A	Active when CN1-41 input signal is OFF (open).																																																					
	B	Active when CN1-42 input signal is OFF (open).																																																					
	C	Active when CN1-43 input signal is OFF (open).																																																					
	D	Active when CN1-44 input signal is OFF (open).																																																					
	E	Active when CN1-45 input signal is OFF (open).																																																					
	F	Active when CN1-46 input signal is OFF (open).																																																					
	/SPD-A (Internal Set Speed Selection Input) Signal Allocation																																																						
	n.□□X□	0 to F The allocations are the same as the /SPD-D (Motor Direction) signal allocations.																																																					
	/SPD-B (Internal Set Speed Selection Input) Signal Allocation																																																						
	n.□X□□	0 to F The allocations are the same as the /SPD-D (Motor Direction) signal allocations.																																																					
	/C-SEL (Control Selection Input) Signal Allocation																																																						
	n.X□□□	0 to F The allocations are the same as the /SPD-D (Motor Direction) signal allocations.																																																					

Continued on next page.

Continued from previous page.

Parameter No.	Size	Name	Setting Range	Setting Unit	Default Setting	Applicable Motors	When Enabled	Classification	Reference																																			
Pn50D	2	Input Signal Selections	0000 to FFFF	-	8888	-	After restart	Setup	*1																																			
		<table border="1"> <thead> <tr> <th colspan="2">/ZCLAMP (Zero Clamping Input) Signal Allocation</th> <th>Applicable Motors</th> </tr> </thead> <tbody> <tr> <td>0</td> <td>Active when CN1-40 input signal is ON (closed).</td> <td rowspan="14">All</td> </tr> <tr> <td>1</td> <td>Active when CN1-41 input signal is ON (closed).</td> </tr> <tr> <td>2</td> <td>Active when CN1-42 input signal is ON (closed).</td> </tr> <tr> <td>3</td> <td>Active when CN1-43 input signal is ON (closed).</td> </tr> <tr> <td>4</td> <td>Active when CN1-44 input signal is ON (closed).</td> </tr> <tr> <td>5</td> <td>Active when CN1-45 input signal is ON (closed).</td> </tr> <tr> <td>6</td> <td>Active when CN1-46 input signal is ON (closed).</td> </tr> <tr> <td>7</td> <td>The signal is always active.</td> </tr> <tr> <td>8</td> <td>The signal is always inactive.</td> </tr> <tr> <td>9</td> <td>Active when CN1-40 input signal is OFF (open).</td> </tr> <tr> <td>A</td> <td>Active when CN1-41 input signal is OFF (open).</td> </tr> <tr> <td>B</td> <td>Active when CN1-42 input signal is OFF (open).</td> </tr> <tr> <td>C</td> <td>Active when CN1-43 input signal is OFF (open).</td> </tr> <tr> <td>D</td> <td>Active when CN1-44 input signal is OFF (open).</td> </tr> <tr> <td>E</td> <td>Active when CN1-45 input signal is OFF (open).</td> </tr> <tr> <td>F</td> <td>Active when CN1-46 input signal is OFF (open).</td> </tr> </tbody> </table>							/ZCLAMP (Zero Clamping Input) Signal Allocation		Applicable Motors	0	Active when CN1-40 input signal is ON (closed).	All	1	Active when CN1-41 input signal is ON (closed).	2	Active when CN1-42 input signal is ON (closed).	3	Active when CN1-43 input signal is ON (closed).	4	Active when CN1-44 input signal is ON (closed).	5	Active when CN1-45 input signal is ON (closed).	6	Active when CN1-46 input signal is ON (closed).	7	The signal is always active.	8	The signal is always inactive.	9	Active when CN1-40 input signal is OFF (open).	A	Active when CN1-41 input signal is OFF (open).	B	Active when CN1-42 input signal is OFF (open).	C	Active when CN1-43 input signal is OFF (open).	D	Active when CN1-44 input signal is OFF (open).	E	Active when CN1-45 input signal is OFF (open).	F	Active when CN1-46 input signal is OFF (open).
	/ZCLAMP (Zero Clamping Input) Signal Allocation		Applicable Motors																																									
	0	Active when CN1-40 input signal is ON (closed).	All																																									
	1	Active when CN1-41 input signal is ON (closed).																																										
	2	Active when CN1-42 input signal is ON (closed).																																										
	3	Active when CN1-43 input signal is ON (closed).																																										
	4	Active when CN1-44 input signal is ON (closed).																																										
	5	Active when CN1-45 input signal is ON (closed).																																										
	6	Active when CN1-46 input signal is ON (closed).																																										
	7	The signal is always active.																																										
	8	The signal is always inactive.																																										
	9	Active when CN1-40 input signal is OFF (open).																																										
	A	Active when CN1-41 input signal is OFF (open).																																										
	B	Active when CN1-42 input signal is OFF (open).																																										
	C	Active when CN1-43 input signal is OFF (open).																																										
	D	Active when CN1-44 input signal is OFF (open).																																										
	E	Active when CN1-45 input signal is OFF (open).																																										
	F	Active when CN1-46 input signal is OFF (open).																																										
		<table border="1"> <thead> <tr> <th colspan="2">/INHIBIT (Reference Pulse Inhibit Input) Signal Allocation</th> <th>Applicable Motors</th> </tr> </thead> <tbody> <tr> <td>0 to F</td> <td>The allocations are the same as the /ZCLAMP (Zero Clamping Input) signal allocations.</td> <td>All</td> </tr> </tbody> </table>							/INHIBIT (Reference Pulse Inhibit Input) Signal Allocation		Applicable Motors	0 to F	The allocations are the same as the /ZCLAMP (Zero Clamping Input) signal allocations.	All																														
/INHIBIT (Reference Pulse Inhibit Input) Signal Allocation		Applicable Motors																																										
0 to F	The allocations are the same as the /ZCLAMP (Zero Clamping Input) signal allocations.	All																																										
	<table border="1"> <thead> <tr> <th colspan="2">/G-SEL (Gain Selection Input) Signal Allocation</th> <th>Applicable Motors</th> </tr> </thead> <tbody> <tr> <td>0 to F</td> <td>The allocations are the same as the /ZCLAMP (Zero Clamping Input) signal allocations.</td> <td>All</td> </tr> </tbody> </table>							/G-SEL (Gain Selection Input) Signal Allocation		Applicable Motors	0 to F	The allocations are the same as the /ZCLAMP (Zero Clamping Input) signal allocations.	All																															
/G-SEL (Gain Selection Input) Signal Allocation		Applicable Motors																																										
0 to F	The allocations are the same as the /ZCLAMP (Zero Clamping Input) signal allocations.	All																																										
	<table border="1"> <thead> <tr> <th colspan="2">/P-DET (Polarity Detection Input) Signal Allocation</th> <th>Applicable Motors</th> </tr> </thead> <tbody> <tr> <td>0 to F</td> <td>The allocations are the same as the /ZCLAMP (Zero Clamping Input) signal allocations.</td> <td>Linear</td> </tr> </tbody> </table>							/P-DET (Polarity Detection Input) Signal Allocation		Applicable Motors	0 to F	The allocations are the same as the /ZCLAMP (Zero Clamping Input) signal allocations.	Linear																															
/P-DET (Polarity Detection Input) Signal Allocation		Applicable Motors																																										
0 to F	The allocations are the same as the /ZCLAMP (Zero Clamping Input) signal allocations.	Linear																																										

Continued on next page.

5.1 SERVOPACKs with Analog Voltage/Pulse Train References

5.1.2 List of Parameters

Continued from previous page.

Parameter No.	Size	Name	Setting Range	Setting Unit	Default Setting	Applicable Motors	When Enabled	Classification	Reference		
Pn50E	2	Output Signal Selections 1	0000 to 6666	–	3211	All	After restart	Setup	*1		
	n.□□□X	/COIN (Positioning Completion Output) Signal Allocation									
		0	Disabled (the above signal output is not used).								
		1	Output the signal from the CN1-25 or CN1-26 output terminal.								
		2	Output the signal from the CN1-27 or CN1-28 output terminal.								
		3	Output the signal from the CN1-29 or CN1-30 output terminal.								
		4	Output the signal from the CN1-37 output terminal.								
		5	Output the signal from the CN1-38 output terminal.								
	n.□□□□	/V-CMP (Speed Coincidence Detection Output) Signal Allocation									
		0 to 6	The allocations are the same as the /COIN (Positioning Completion) signal allocations.								
	n.□X□□□	/TGON (Rotation Detection Output) Signal Allocation									
		0 to 6	The allocations are the same as the /COIN (Positioning Completion) signal allocations.								
	n.X□□□□	/S-RDY (Servo Ready) Signal Allocation									
		0 to 6	The allocations are the same as the /COIN (Positioning Completion) signal allocations.								
	Pn50F	2	Output Signal Selections 2	0000 to 6666	–	0000	All	After restart	Setup	*1	
		n.□□□X	/CLT (Torque Limit Detection Output) Signal Allocation								
			0	Disabled (the above signal output is not used).							
1			Output the signal from the CN1-25 or CN1-26 output terminal.								
2			Output the signal from the CN1-27 or CN1-28 output terminal.								
3			Output the signal from the CN1-29 or CN1-30 output terminal.								
4			Output the signal from the CN1-37 output terminal.								
5			Output the signal from the CN1-38 output terminal.								
n.□□□□		/VLT (Speed Limit Detection) Signal Allocation									
		0 to 6	The allocations are the same as the /CLT (Torque Limit Detection Output) signal allocations.								
n.□X□□□		/BK (Brake Output) Signal Allocation									
		0 to 6	The allocations are the same as the /CLT (Torque Limit Detection Output) signal allocations.								
n.X□□□□		/WARN (Warning Output) Signal Allocation									
		0 to 6	The allocations are the same as the /CLT (Torque Limit Detection Output) signal allocations.								

Continued on next page.

Continued from previous page.

Parameter No.	Size	Name	Setting Range	Setting Unit	Default Setting	Applicable Motors	When Enabled	Classification	Reference		
Pn510	2	Output Signal Selections 3	0000 to 0666	-	0000	All	After restart	Setup	*1		
	n.□□□X	/NEAR (Near Output) Signal Allocation									
		0	Disabled (the above signal output is not used).								
		1	Output the signal from the CN1-25 or CN1-26 output terminal.								
		2	Output the signal from the CN1-27 or CN1-28 output terminal.								
		3	Output the signal from the CN1-29 or CN1-30 output terminal.								
		4	Output the signal from the CN1-37 output terminal.								
		5	Output the signal from the CN1-38 output terminal.								
	6	Output the signal from the CN1-39 output terminal.									
	n.□□X□	Reserved parameter (Do not change.)									
n.□X□□	/PSELA (Reference Pulse Input Multiplication Switching Output) Signal Allocation										
	0 to 6	The allocations are the same as the /NEAR (Near) signal allocations.									
n.X□□□	Reserved parameter (Do not change.)										
Pn512	2	Output Signal Inverse Settings	0000 to 1111	-	0000	All	After restart	Setup	*1		
	n.□□□X	Output Signal Inversion for CN1-25 and CN1-26 Terminals									
		0	The signal is not inverted.								
	1	The signal is inverted.									
	n.□□X□	Output Signal Inversion for CN1-27 and CN1-28 Terminals									
		0	The signal is not inverted.								
	1	The signal is inverted.									
	n.□X□□	Output Signal Inversion for CN1-29 and CN1-30 Terminals									
		0	The signal is not inverted.								
	1	The signal is inverted.									
	n.X□□□	Output Signal Inversion for CN1-37 Terminal									
		0	The signal is not inverted.								
	1	The signal is inverted.									
	Pn513	2	Output Signal Inverse Settings 2	0000 to 0011	-	0000	All	After restart	Setup	*1	
		n.□□□X	Output Signal Inversion for CN1-38 Terminal								
			0	The signal is not inverted.							
		1	The signal is inverted.								
n.□□X□		Output Signal Inversion for CN1-39 Terminal									
		0	The signal is not inverted.								
1		The signal is inverted.									
n.□X□□		Reserved parameter (Do not change.)									
n.X□□□		Reserved parameter (Do not change.)									

Continued on next page.

5.1 SERVOPACKs with Analog Voltage/Pulse Train References

5.1.2 List of Parameters

Continued from previous page.

Parameter No.	Size	Name	Setting Range	Setting Unit	Default Setting	Applicable Motors	When Enabled	Classification	Reference	
Pn514	2	Output Signal Selections 4	0000 to 0666	–	0000	All	After restart	Setup	*1	
		n.□□□X	Reserved parameter (Do not change.)							
		n.□□X□	Reserved parameter (Do not change.)							
		n.□X□□	/PM (Preventative Maintenance Output) Signal Allocation							
			0	Disabled (the above signal output is not used).						
			1	Output the signal from the CN1-25 or CN1-26 output terminal.						
			2	Output the signal from the CN1-27 or CN1-28 output terminal.						
			3	Output the signal from the CN1-29 or CN1-30 output terminal.						
			4	Output the signal from the CN1-37 output terminal.						
			5	Output the signal from the CN1-38 output terminal.						
			6	Output the signal from the CN1-39 output terminal.						
		n.X□□□	Reserved parameter (Do not change.)							

Continued on next page.

Continued from previous page.

Parameter No.	Size	Name	Setting Range	Setting Unit	Default Setting	Applicable Motors	When Enabled	Classification	Reference																																																																									
Pn515	2	Input Signal Selections 6	0000 to FFFF	–	8888	All	After restart	Setup	*1																																																																									
	<table border="1"> <thead> <tr> <th colspan="2">SEN (Absolute Data Request Input) Signal Allocation</th> </tr> </thead> <tbody> <tr><td>0</td><td>Active when CN1-40 input signal is ON (closed).</td></tr> <tr><td>1</td><td>Active when CN1-41 input signal is ON (closed).</td></tr> <tr><td>2</td><td>Active when CN1-42 input signal is ON (closed).</td></tr> <tr><td>3</td><td>Active when CN1-43 input signal is ON (closed).</td></tr> <tr><td>4</td><td>Active when CN1-44 input signal is ON (closed).</td></tr> <tr><td>5</td><td>Active when CN1-45 input signal is ON (closed).</td></tr> <tr><td>6</td><td>Active when CN1-46 input signal is ON (closed).</td></tr> <tr><td>n.□□□X</td><td>7 The signal is always active.</td></tr> <tr><td>8</td><td>Enable when 5 V is input to CN1-4.</td></tr> <tr><td>9</td><td>Active when CN1-40 input signal is OFF (open).</td></tr> <tr><td>A</td><td>Active when CN1-41 input signal is OFF (open).</td></tr> <tr><td>B</td><td>Active when CN1-42 input signal is OFF (open).</td></tr> <tr><td>C</td><td>Active when CN1-43 input signal is OFF (open).</td></tr> <tr><td>D</td><td>Active when CN1-44 input signal is OFF (open).</td></tr> <tr><td>E</td><td>Active when CN1-45 input signal is OFF (open).</td></tr> <tr><td>F</td><td>Active when CN1-46 input signal is OFF (open).</td></tr> </tbody> </table> <table border="1"> <thead> <tr> <th colspan="2">/PSEL (Reference Pulse Input Multiplication Switching Input) Signal Allocation</th> </tr> </thead> <tbody> <tr><td>0</td><td>Active when CN1-40 input signal is ON (closed).</td></tr> <tr><td>1</td><td>Active when CN1-41 input signal is ON (closed).</td></tr> <tr><td>2</td><td>Active when CN1-42 input signal is ON (closed).</td></tr> <tr><td>3</td><td>Active when CN1-43 input signal is ON (closed).</td></tr> <tr><td>4</td><td>Active when CN1-44 input signal is ON (closed).</td></tr> <tr><td>5</td><td>Active when CN1-45 input signal is ON (closed).</td></tr> <tr><td>6</td><td>Active when CN1-46 input signal is ON (closed).</td></tr> <tr><td>n.□□X□</td><td>7 The signal is always enabled.</td></tr> <tr><td>8</td><td>The signal is always inactive.</td></tr> <tr><td>9</td><td>Active when CN1-40 input signal is OFF (open).</td></tr> <tr><td>A</td><td>Active when CN1-41 input signal is OFF (open).</td></tr> <tr><td>B</td><td>Active when CN1-42 input signal is OFF (open).</td></tr> <tr><td>C</td><td>Active when CN1-43 input signal is OFF (open).</td></tr> <tr><td>D</td><td>Active when CN1-44 input signal is OFF (open).</td></tr> <tr><td>E</td><td>Active when CN1-45 input signal is OFF (open).</td></tr> <tr><td>F</td><td>Active when CN1-46 input signal is OFF (open).</td></tr> </tbody> </table> <table border="1"> <tr> <td>n.□X□□</td> <td>Reserved parameter (Do not change.)</td> </tr> <tr> <td>n.X□□□</td> <td>Reserved parameter (Do not change.)</td> </tr> </table>										SEN (Absolute Data Request Input) Signal Allocation		0	Active when CN1-40 input signal is ON (closed).	1	Active when CN1-41 input signal is ON (closed).	2	Active when CN1-42 input signal is ON (closed).	3	Active when CN1-43 input signal is ON (closed).	4	Active when CN1-44 input signal is ON (closed).	5	Active when CN1-45 input signal is ON (closed).	6	Active when CN1-46 input signal is ON (closed).	n.□□□X	7 The signal is always active.	8	Enable when 5 V is input to CN1-4.	9	Active when CN1-40 input signal is OFF (open).	A	Active when CN1-41 input signal is OFF (open).	B	Active when CN1-42 input signal is OFF (open).	C	Active when CN1-43 input signal is OFF (open).	D	Active when CN1-44 input signal is OFF (open).	E	Active when CN1-45 input signal is OFF (open).	F	Active when CN1-46 input signal is OFF (open).	/PSEL (Reference Pulse Input Multiplication Switching Input) Signal Allocation		0	Active when CN1-40 input signal is ON (closed).	1	Active when CN1-41 input signal is ON (closed).	2	Active when CN1-42 input signal is ON (closed).	3	Active when CN1-43 input signal is ON (closed).	4	Active when CN1-44 input signal is ON (closed).	5	Active when CN1-45 input signal is ON (closed).	6	Active when CN1-46 input signal is ON (closed).	n.□□X□	7 The signal is always enabled.	8	The signal is always inactive.	9	Active when CN1-40 input signal is OFF (open).	A	Active when CN1-41 input signal is OFF (open).	B	Active when CN1-42 input signal is OFF (open).	C	Active when CN1-43 input signal is OFF (open).	D	Active when CN1-44 input signal is OFF (open).	E	Active when CN1-45 input signal is OFF (open).	F	Active when CN1-46 input signal is OFF (open).	n.□X□□	Reserved parameter (Do not change.)	n.X□□□	Reserved parameter (Do not change.)
	SEN (Absolute Data Request Input) Signal Allocation																																																																																	
	0	Active when CN1-40 input signal is ON (closed).																																																																																
	1	Active when CN1-41 input signal is ON (closed).																																																																																
	2	Active when CN1-42 input signal is ON (closed).																																																																																
	3	Active when CN1-43 input signal is ON (closed).																																																																																
	4	Active when CN1-44 input signal is ON (closed).																																																																																
	5	Active when CN1-45 input signal is ON (closed).																																																																																
	6	Active when CN1-46 input signal is ON (closed).																																																																																
	n.□□□X	7 The signal is always active.																																																																																
	8	Enable when 5 V is input to CN1-4.																																																																																
	9	Active when CN1-40 input signal is OFF (open).																																																																																
	A	Active when CN1-41 input signal is OFF (open).																																																																																
	B	Active when CN1-42 input signal is OFF (open).																																																																																
	C	Active when CN1-43 input signal is OFF (open).																																																																																
	D	Active when CN1-44 input signal is OFF (open).																																																																																
	E	Active when CN1-45 input signal is OFF (open).																																																																																
	F	Active when CN1-46 input signal is OFF (open).																																																																																
	/PSEL (Reference Pulse Input Multiplication Switching Input) Signal Allocation																																																																																	
	0	Active when CN1-40 input signal is ON (closed).																																																																																
	1	Active when CN1-41 input signal is ON (closed).																																																																																
	2	Active when CN1-42 input signal is ON (closed).																																																																																
	3	Active when CN1-43 input signal is ON (closed).																																																																																
	4	Active when CN1-44 input signal is ON (closed).																																																																																
	5	Active when CN1-45 input signal is ON (closed).																																																																																
	6	Active when CN1-46 input signal is ON (closed).																																																																																
	n.□□X□	7 The signal is always enabled.																																																																																
8	The signal is always inactive.																																																																																	
9	Active when CN1-40 input signal is OFF (open).																																																																																	
A	Active when CN1-41 input signal is OFF (open).																																																																																	
B	Active when CN1-42 input signal is OFF (open).																																																																																	
C	Active when CN1-43 input signal is OFF (open).																																																																																	
D	Active when CN1-44 input signal is OFF (open).																																																																																	
E	Active when CN1-45 input signal is OFF (open).																																																																																	
F	Active when CN1-46 input signal is OFF (open).																																																																																	
n.□X□□	Reserved parameter (Do not change.)																																																																																	
n.X□□□	Reserved parameter (Do not change.)																																																																																	

Continued on next page.

5.1 SERVOPACKs with Analog Voltage/Pulse Train References

5.1.2 List of Parameters

Continued from previous page.

Parameter No.	Size	Name	Setting Range	Setting Unit	Default Setting	Applicable Motors	When Enabled	Classification	Reference	
Pn516	2	Input Signal Selections 7	0000 to FFFF	–	8888	All	After restart	Setup	*1	
	n.□□□X		FSTP (Forced Stop Input) Signal Allocation							
			0	Enable drive when CN1-40 input signal is ON (closed).						
			1	Enable drive when CN1-41 input signal is ON (closed).						
			2	Enable drive when CN1-42 input signal is ON (closed).						
			3	Enable drive when CN1-43 input signal is ON (closed).						
			4	Enable drive when CN1-44 input signal is ON (closed).						
			5	Enable drive when CN1-45 input signal is ON (closed).						
			6	Enable drive when CN1-46 input signal is ON (closed).						
			7	Set the signal to always prohibit drive (always force the motor to stop).						
			8	Set the signal to always enable drive (always disable forcing the motor to stop).						
			9	Enable drive when CN1-40 input signal is OFF (open).						
			A	Enable drive when CN1-41 input signal is OFF (open).						
			B	Enable drive when CN1-42 input signal is OFF (open).						
			C	Enable drive when CN1-43 input signal is OFF (open).						
			D	Enable drive when CN1-44 input signal is OFF (open).						
			E	Enable drive when CN1-45 input signal is OFF (open).						
			F	Enable drive when CN1-46 input signal is OFF (open).						
	n.□□X□		Reserved parameter (Do not change.)							
	n.□X□□		Reserved parameter (Do not change.)							
n.X□□□		Reserved parameter (Do not change.)								
Pn517	2	Output Signal Selections 5	0000 to 0666	–	0654	All	After restart	Setup	*1	
	n.□□□X		ALO1 (Alarm Code Output) Signal Allocation							
			0	Disabled (the above signal output is not used).						
			1	Output the signal from the CN1-25 or CN1-26 output terminal.						
			2	Output the signal from the CN1-27 or CN1-28 output terminal.						
			3	Output the signal from the CN1-29 or CN1-30 output terminal.						
			4	Output the signal from the CN1-37 output terminal.						
			5	Output the signal from the CN1-38 output terminal.						
			6	Output the signal from the CN1-39 output terminal.						
	n.□□X□		ALO2 (Alarm Code Output) Signal Allocation							
		0 to 6	The allocations are the same as the ALO1 (Alarm Code Output) signal allocations.							
n.□X□□		ALO3 (Alarm Code Output) Signal Allocation								
		0 to 6	The allocations are the same as the ALO1 (Alarm Code Output) signal allocations.							
n.X□□□		Reserved parameter (Do not change.)								
Pn518*3	–	Safety Module-Related Parameters	–	–	–	All	–	–	–	
Pn51B	4	Motor-Load Position Deviation Overflow Detection Level	0 to 1,073,741,824	1 reference unit	1000	Rotary	Immediately	Setup	*1	

Continued on next page.

Continued from previous page.

Parameter No.	Size	Name	Setting Range	Setting Unit	Default Setting	Applicable Motors	When Enabled	Classification	Reference														
Pn51E	2	Position Deviation Overflow Warning Level	10 to 100	1%	100	All	Immediately	Setup	*1														
Pn520	4	Position Deviation Overflow Alarm Level	1 to 1,073,741,823	1 reference unit	5242880	All	Immediately	Setup	*1														
Pn522	4	Positioning Completed Width	0 to 1,073,741,824	1 reference unit	7	All	Immediately	Setup	*1														
Pn524	4	Near Signal Width	1 to 1,073,741,824	1 reference unit	1073741824	All	Immediately	Setup	*1														
Pn526	4	Position Deviation Overflow Alarm Level at Servo ON	1 to 1,073,741,823	1 reference unit	5242880	All	Immediately	Setup	*1														
Pn528	2	Position Deviation Overflow Warning Level at Servo ON	10 to 100	1%	100	All	Immediately	Setup	*1														
Pn529	2	Speed Limit Level at Servo ON	0 to 10,000	1 min ⁻¹	10000	Rotary	Immediately	Setup	*1														
Pn52A	2	Multiplier per Fully-closed Rotation	0 to 100	1%	20	Rotary	Immediately	Tuning	*1														
Pn52B	2	Overload Warning Level	1 to 100	1%	20	All	Immediately	Setup	*1														
Pn52C	2	Base Current Derating at Motor Overload Detection	10 to 100	1%	100	All	After restart	Setup	*1														
Pn52D	2	Reserved parameter (Do not change.)	–	–	50	All	–	–	–														
Pn52F	2	Monitor Display at Startup	0000 to OFFF	–	OFFF	All	Immediately	Setup	*1														
Pn530	2	Program Jogging-Related Selections	<table border="1"> <thead> <tr> <th colspan="2">Program Jogging Operation Pattern</th> </tr> </thead> <tbody> <tr> <td>0</td> <td>(Waiting time in Pn535 → Forward by travel distance in Pn531) × Number of movements in Pn536</td> </tr> <tr> <td>1</td> <td>(Waiting time in Pn535 → Reverse by travel distance in Pn531) × Number of movements in Pn536</td> </tr> <tr> <td>2</td> <td>(Waiting time in Pn535 → Forward by travel distance in Pn531) × Number of movements in Pn536 (Waiting time in Pn535 → Reverse by travel distance in Pn531) × Number of movements in Pn536</td> </tr> <tr> <td>3</td> <td>(Waiting time in Pn535 → Reverse by travel distance in Pn531) × Number of movements in Pn536 (Waiting time in Pn535 → Forward by travel distance in Pn531) × Number of movements in Pn536</td> </tr> <tr> <td>4</td> <td>(Waiting time in Pn535 → Forward by travel distance in Pn531 → Waiting time in Pn535 → Reserve by travel distance in Pn531) × Number of movements in Pn536</td> </tr> <tr> <td>5</td> <td>(Waiting time in Pn535 → Reverse by travel distance in Pn531 → Waiting time in Pn535 → Forward by travel distance in Pn531) × Number of movements in Pn536</td> </tr> </tbody> </table>							Program Jogging Operation Pattern		0	(Waiting time in Pn535 → Forward by travel distance in Pn531) × Number of movements in Pn536	1	(Waiting time in Pn535 → Reverse by travel distance in Pn531) × Number of movements in Pn536	2	(Waiting time in Pn535 → Forward by travel distance in Pn531) × Number of movements in Pn536 (Waiting time in Pn535 → Reverse by travel distance in Pn531) × Number of movements in Pn536	3	(Waiting time in Pn535 → Reverse by travel distance in Pn531) × Number of movements in Pn536 (Waiting time in Pn535 → Forward by travel distance in Pn531) × Number of movements in Pn536	4	(Waiting time in Pn535 → Forward by travel distance in Pn531 → Waiting time in Pn535 → Reserve by travel distance in Pn531) × Number of movements in Pn536	5	(Waiting time in Pn535 → Reverse by travel distance in Pn531 → Waiting time in Pn535 → Forward by travel distance in Pn531) × Number of movements in Pn536
			Program Jogging Operation Pattern																				
			0	(Waiting time in Pn535 → Forward by travel distance in Pn531) × Number of movements in Pn536																			
			1	(Waiting time in Pn535 → Reverse by travel distance in Pn531) × Number of movements in Pn536																			
			2	(Waiting time in Pn535 → Forward by travel distance in Pn531) × Number of movements in Pn536 (Waiting time in Pn535 → Reverse by travel distance in Pn531) × Number of movements in Pn536																			
			3	(Waiting time in Pn535 → Reverse by travel distance in Pn531) × Number of movements in Pn536 (Waiting time in Pn535 → Forward by travel distance in Pn531) × Number of movements in Pn536																			
			4	(Waiting time in Pn535 → Forward by travel distance in Pn531 → Waiting time in Pn535 → Reserve by travel distance in Pn531) × Number of movements in Pn536																			
			5	(Waiting time in Pn535 → Reverse by travel distance in Pn531 → Waiting time in Pn535 → Forward by travel distance in Pn531) × Number of movements in Pn536																			
n.□□□□	Reserved parameter (Do not change.)																						
n.□X□□	Reserved parameter (Do not change.)																						
n.X□□□	Reserved parameter (Do not change.)																						
Pn531	4	Program Jogging Travel Distance	1 to 1,073,741,824	1 reference unit	32768	All	Immediately	Setup	*1														

Continued on next page.

5.1 SERVOPACKs with Analog Voltage/Pulse Train References

5.1.2 List of Parameters

Continued from previous page.

Parameter No.	Size	Name	Setting Range	Setting Unit	Default Setting	Applicable Motors	When Enabled	Classification	Reference
Pn533	2	Program Jogging Movement Speed	1 to 10,000	Rotary: 1 min ⁻¹ Direct Drive: 0.1 min ⁻¹	500	Rotary	Immediately	Setup	*1
Pn534	2	Program Jogging Acceleration/Deceleration Time	2 to 10,000	1 ms	100	All	Immediately	Setup	*1
Pn535	2	Program Jogging Waiting Time	0 to 10,000	1 ms	100	All	Immediately	Setup	*1
Pn536	2	Program Jogging Number of Movements	0 to 1,000	Times	1	All	Immediately	Setup	*1
Pn550	2	Analog Monitor 1 Offset Voltage	-10,000 to 10,000	0.1 V	0	All	Immediately	Setup	*1
Pn551	2	Analog Monitor 2 Offset Voltage	-10,000 to 10,000	0.1 V	0	All	Immediately	Setup	*1
Pn552	2	Analog Monitor 1 Magnification	-10,000 to 10,000	× 0.01	100	All	Immediately	Setup	*1
Pn553	2	Analog Monitor 2 Magnification	-10,000 to 10,000	× 0.01	100	All	Immediately	Setup	*1
Pn55A	2	Power Consumption Monitor Unit Time	1 to 1,440	1 min	1	All	Immediately	Setup	–
Pn560	2	Residual Vibration Detection Width	1 to 3,000	0.1%	400	All	Immediately	Setup	*1
Pn561	2	Overshoot Detection Level	0 to 100	1%	100	All	Immediately	Setup	*1
Pn580	2	Zero Clamping Level	0 to 10,000	1 mm/s	10	Linear	Immediately	Setup	*1
Pn581	2	Zero Speed Level	1 to 10,000	1 mm/s	20	Linear	Immediately	Setup	*1
Pn582	2	Speed Coincidence Detection Signal Output Width	0 to 100	1 mm/s	10	Linear	Immediately	Setup	*1
Pn583	2	Brake Reference Output Speed Level	0 to 10,000	1 mm/s	10	Linear	Immediately	Setup	*1
Pn584	2	Speed Limit Level at Servo ON	0 to 10,000	1 mm/s	10000	Linear	Immediately	Setup	*1
Pn585	2	Program Jogging Movement Speed	1 to 10,000	1 mm/s	50	Linear	Immediately	Setup	*1
Pn586	2	Motor Running Cooling Ratio	0 to 100	1%/Max. speed	0	Linear	Immediately	Setup	–
Pn600	2	Regenerative Resistor Capacity ^{*4}	Depends on model. ^{*5}	10 W	0	All	Immediately	Setup	*1
Pn601	2	Dynamic Brake Resistor Allowable Energy Consumption	0 to 65,535	10 J	0	All	After restart	Setup	*6
Pn603	2	Regenerative Resistance	0 to 65,535	10 mΩ	0	All	Immediately	Setup	*1
Pn604	2	Dynamic Brake Resistance	0 to 65,535	10 mΩ	0	All	After restart	Setup	*6
Pn621 to Pn628 ^{*3}	–	Safety Module-Related Parameters	–	–	–	All	–	–	–

*1. Refer to the following manual for details.

 Σ-7-Series Σ-7S SERVOPACK with Analog Voltage/Pulse Train References Product Manual (Manual No.: SIEP S800001 26)

*2. Set a percentage of the motor rated torque.

*3. These parameters are for SERVOPACKs with a Safety Module. Refer to the following manual for details.

 Σ-V-Series/Σ-V-Series for Large-Capacity Models/Σ-7-Series User's Manual Safety Module (Manual No.: SIEP C720829 06)

*4. Normally set this parameter to 0. If you use an External Regenerative Resistor, set the capacity (W) of the External Regenerative Resistor.

*5. The upper limit is the maximum output capacity (W) of the SERVOPACK.

*6. These parameters are for SERVOPACKs with the dynamic brake option. Refer to the following manual for details.

 Σ-7-Series AC Servo Drive Σ-7S/Σ-7W SERVOPACK with Hardware Option Specifications Dynamic Brake Product Manual (Manual No.: SIEP S800001 73)

5.1.3 Parameter Recording Table

Use the following table to record the settings of the parameters.

Parameter No.	Default Setting				Name	When Enabled
Pn000	0000				Basic Function Selections 0	After restart
Pn001	0000				Application Function Selections 1	After restart
Pn002	0000				Application Function Selections 2	After restart
Pn006	0002				Application Function Selections 6	Immediately
Pn007	0000				Application Function Selections 7	Immediately
Pn008	0000				Application Function Selections 8	After restart
Pn009	0010				Application Function Selections 9	After restart
Pn00A	0001				Application Function Selections A	After restart
Pn00B	0000				Application Function Selections B	After restart
Pn00C	0000				Application Function Selections C	After restart
Pn00D	0000				Application Function Selections D	After restart
Pn00F	0000				Application Function Selections F	After restart
Pn010	0001				Axis Address Selection for UART/USB Communications	After restart
Pn040	0000				Σ -V Compatible Function Switch	After restart
Pn021	0000				Reserved parameter	–
Pn080	0000				Application Function Selections 80	After restart
Pn081	0000				Application Function Selections 81	After restart
Pn100	400				Speed Loop Gain	Immediately
Pn101	2000				Speed Loop Integral Time Constant	Immediately
Pn102	400				Position Loop Gain	Immediately
Pn103	100				Moment of Inertia Ratio	Immediately
Pn104	400				Second Speed Loop Gain	Immediately
Pn105	2000				Second Speed Loop Integral Time Constant	Immediately
Pn106	400				Second Position Loop Gain	Immediately
Pn109	0				Feedforward	Immediately
Pn10A	0				Feedforward Filter Time Constant	Immediately
Pn10B	0004				Gain Application Selections	*
Pn10C	200				Mode Switching Level for Torque Reference	Immediately
Pn10D	0				Mode Switching Level for Speed Reference	Immediately
Pn10E	0				Mode Switching Level for Acceleration	Immediately

Continued on next page.

5.1 SERVOPACKs with Analog Voltage/Pulse Train References

5.1.3 Parameter Recording Table

Continued from previous page.

Parameter No.	Default Setting					Name	When Enabled
Pn10F	0					Mode Switching Level for Position Deviation	Immediately
Pn11F	0					Position Integral Time Constant	Immediately
Pn121	100					Friction Compensation Gain	Immediately
Pn122	100					Second Friction Compensation Gain	Immediately
Pn123	0					Friction Compensation Coefficient	Immediately
Pn124	0					Friction Compensation Frequency Correction	Immediately
Pn125	100					Friction Compensation Gain Correction	Immediately
Pn131	0					Gain Switching Time 1	Immediately
Pn132	0					Gain Switching Time 2	Immediately
Pn135	0					Gain Switching Waiting Time 1	Immediately
Pn136	0					Gain Switching Waiting Time 2	Immediately
Pn139	0000					Automatic Gain Switching Selections 1	Immediately
Pn13D	2000					Current Gain Level	Immediately
Pn13F	0					Less-Deviation Control 2 Second Position Integral Time Constant	Immediately
Pn140	0100					Model Following Control-Related Selections	Immediately
Pn141	500					Model Following Control Gain	Immediately
Pn142	1000					Model Following Control Gain Correction	Immediately
Pn143	1000					Model Following Control Bias in the Forward Direction	Immediately
Pn144	1000					Model Following Control Bias in the Reverse Direction	Immediately
Pn145	500					Vibration Suppression 1 Frequency A	Immediately
Pn146	700					Vibration Suppression 1 Frequency B	Immediately
Pn147	1000					Model Following Control Speed Feedforward Compensation	Immediately
Pn148	500					Second Model Following Control Gain	Immediately
Pn149	1000					Second Model Following Control Gain Correction	Immediately
Pn14A	800					Vibration Suppression 2 Frequency	Immediately
Pn14B	100					Vibration Suppression 2 Correction	Immediately
Pn14F	0021					Control-Related Selections	After restart
Pn160	0010					Anti-Resonance Control-Related Selections	Immediately
Pn161	1000					Anti-Resonance Frequency	Immediately

Continued on next page.

Continued from previous page.

Parameter No.	Default Setting				Name	When Enabled
Pn162	100				Anti-Resonance Gain Correction	Immediately
Pn163	0				Anti-Resonance Damping Gain	Immediately
Pn164	0				Anti-Resonance Filter Time Constant 1 Correction	Immediately
Pn165	0				Anti-Resonance Filter Time Constant 2 Correction	Immediately
Pn166	0				Anti-Resonance Damping Gain 2	Immediately
Pn170	1400				Tuning-less Function-Related Selections	*
Pn181	0				Mode Switching Level for Speed Reference	Immediately
Pn182	0				Mode Switching Level for Acceleration	Immediately
Pn190	0100				Less-Deviation Control-Related Switches	After restart
Pn191	1000				Less-Deviation Control 1 Feedforward Gain	Immediately
Pn192	1000				Less-Deviation Control 1 Second Feedforward Gain	Immediately
Pn193	30				Less-Deviation Control 1 Feedforward Filter Time Constant	Immediately
Pn195	2102				Less-Deviation Function Selection Switches	After restart
Pn196	1000				Less-Deviation Control 2 Speed Feedforward Gain	Immediately
Pn197	50				Less-Deviation Control 2 Torque Feedforward Filter Time Constant	Immediately
Pn198	1000				Less-Deviation Control 2 Forward Torque Feedforward Gain	Immediately
Pn199	1000				Less-Deviation Control 2 Reverse Torque Feedforward Gain	Immediately
Pn19A	10000				Less-Deviation Control 2 Incomplete Integration Rate	Immediately
Pn19B	0				Less-Deviation Control 2 Rotary Servomotor Viscous Friction Compensation Coefficient	Immediately
Pn19C	0				Reserved parameter	Immediately
Pn19D	0				Less-Deviation Control 2 Linear Servomotor Viscous Friction Compensation Coefficient	Immediately
Pn19E	0				Reserved parameter	Immediately
Pn19F	0				Less-Deviation Control 2 Torque Feedforward Moving Average Time	Immediately
Pn1A4	36				Reserved parameter	Immediately
Pn1A5	0				Reserved parameter	Immediately
Pn1AE	0				Reserved parameter	Immediately
Pn1AF	0				Reserved parameter	Immediately

Continued on next page.

5.1 SERVOPACKs with Analog Voltage/Pulse Train References

5.1.3 Parameter Recording Table

Continued from previous page.

Parameter No.	Default Setting					Name	When Enabled
Pn200	0000					Position Control Reference For Selections	After restart
Pn205	65535					Multiturn Limit	After restart
Pn207	1000					Position Control Function Selections	After restart
Pn20A	32768					Number of External Scale Pitches	After restart
Pn20E	64					Electronic Gear Ratio (Numerator)	After restart
Pn210	1					Electronic Gear Ratio (Denominator)	After restart
Pn212	2048					Number of Encoder Output Pulses	After restart
Pn216	0					Position Reference Acceleration/Deceleration Time Constant	Immediately after the motor stops
Pn217	0					Average Position Reference Movement Time	Immediately after the motor stops
Pn218	1					Reference Pulse Input Multiplier	Immediately
Pn22A	0000					Fully-closed Control Selections	After restart
Pn234	0					Second Position Reference Acceleration/Deceleration Time Constant	Immediately
Pn281	20					Encoder Output Resolution	After restart
Pn282	0					Linear Encoder Scale Pitch	After restart
Pn300	600					Speed Reference Input Gain	Immediately
Pn301	100					Internal Set Speed 1	Immediately
Pn302	200					Internal Set Speed 2	Immediately
Pn303	300					Internal Set Speed 3	Immediately
Pn304	500					Jogging Speed	Immediately
Pn305	0					Soft Start Acceleration Time	Immediately
Pn306	0					Soft Start Deceleration Time	Immediately
Pn307	40					Speed Reference Filter Time Constant	Immediately
Pn308	0					Speed Feedback Filter Time Constant	Immediately
Pn30A	0					Deceleration Time for Servo OFF and Forced Stops	Immediately
Pn30C	0					Speed Feedforward Average Movement Time	Immediately
Pn310	0000					Vibration Detection Selections	Immediately
Pn311	100					Vibration Detection Sensitivity	Immediately
Pn312	50					Vibration Detection Level	Immediately
Pn316	10000					Maximum Motor Speed	After restart
Pn324	300					Moment of Inertia Calculation Starting Level	Immediately
Pn380	10					Internal Set Speed 1	Immediately

Continued on next page.

Continued from previous page.

Parameter No.	Default Setting				Name	When Enabled
Pn381	20				Internal Set Speed 2	Immediately
Pn382	30				Internal Set Speed 3	Immediately
Pn383	50				Jogging Speed	Immediately
Pn384	10				Vibration Detection Level	Immediately
Pn385	50				Maximum Motor Speed	After restart
Pn400	30				Torque Reference Input Gain	Immediately
Pn401	100				First Stage First Torque Reference Filter Time Constant	Immediately
Pn402	800				Forward Torque Limit	Immediately
Pn403	800				Reverse Torque Limit	Immediately
Pn404	100				Forward External Torque Limit	Immediately
Pn405	100				Reverse External Torque Limit	Immediately
Pn406	800				Emergency Stop Torque	Immediately
Pn407	10000				Speed Limit during Torque Control	Immediately
Pn408	0000				Torque-Related Function Selections	*
Pn409	5000				First Stage Notch Filter Frequency	Immediately
Pn40A	70				First Stage Notch Filter Q Value	Immediately
Pn40B	0				First Stage Notch Filter Depth	Immediately
Pn40C	5000				Second Stage Notch Filter Frequency	Immediately
Pn40D	70				Second Stage Notch Filter Q Value	Immediately
Pn40E	0				Second Stage Notch Filter Depth	Immediately
Pn40F	5000				Second Stage Second Torque Reference Filter Frequency	Immediately
Pn410	50				Second Stage Second Notch Filter Q Value	Immediately
Pn412	100				First Stage Second Torque Reference Filter Time Constant	Immediately
Pn415	0				T-REF Filter Time Constant	Immediately
Pn416	0000				Torque-Related Function Selections 2	Immediately
Pn417	5000				Third Stage Notch Filter Frequency	Immediately
Pn418	70				Third Stage Notch Filter Q Value	Immediately
Pn419	0				Third Stage Notch Filter Depth	Immediately
Pn41A	5000				Fourth Stage Notch Filter Frequency	Immediately
Pn41B	70				Fourth Stage Notch Filter Q Value	Immediately

Continued on next page.

5.1 SERVOPACKs with Analog Voltage/Pulse Train References

5.1.3 Parameter Recording Table

Continued from previous page.

Parameter No.	Default Setting					Name	When Enabled
Pn41C	0					Fourth Stage Notch Filter Depth	Immediately
Pn41D	5000					Fifth Stage Notch Filter Frequency	Immediately
Pn41E	70					Fifth Stage Notch Filter Q Value	Immediately
Pn41F	0					Fifth Stage Notch Filter Depth	Immediately
Pn423	0000					Speed Ripple Compensation Selections	*
Pn424	50					Torque Limit at Main Circuit Voltage Drop	Immediately
Pn425	100					Release Time for Torque Limit at Main Circuit Voltage Drop	Immediately
Pn426	0					Torque Feedforward Average Movement Time	Immediately
Pn427	0					Speed Ripple Compensation Enable Speed	Immediately
Pn456	15					Sweep Torque Reference Amplitude	Immediately
Pn460	0101					Notch Filter Adjustment Selections 1	Immediately
Pn480	10000					Speed Limit during Force Control	Immediately
Pn481	400					Polarity Detection Speed Loop Gain	Immediately
Pn482	3000					Polarity Detection Speed Loop Integral Time Constant	Immediately
Pn483	30					Forward Force Limit	Immediately
Pn484	30					Reverse Force Limit	Immediately
Pn485	20					Polarity Detection Reference Speed	Immediately
Pn486	25					Polarity Detection Reference Acceleration/Deceleration Time	Immediately
Pn487	0					Polarity Detection Constant Speed Time	Immediately
Pn488	100					Polarity Detection Reference Waiting Time	Immediately
Pn48E	10					Polarity Detection Range	Immediately
Pn490	100					Polarity Detection Load Level	Immediately
Pn495	100					Polarity Detection Confirmation Force Reference	Immediately
Pn498	10					Polarity Detection Allowable Error Range	Immediately
Pn49F	0					Speed Ripple Compensation Enable Speed	Immediately
Pn501	10					Zero Clamping Level	Immediately
Pn502	20					Rotation Detection Level	Immediately
Pn503	10					Speed Coincidence Detection Signal Output Width	Immediately
Pn506	0					Brake Reference-Servo OFF Delay Time	Immediately

Continued on next page.

Continued from previous page.

Parameter No.	Default Setting				Name	When Enabled
Pn507	100				Brake Reference Output Speed Level	Immediately
Pn508	50				Servo OFF-Brake Command Waiting Time	Immediately
Pn509	20				Momentary Power Interruption Hold Time	Immediately
Pn50A	2100				Input Signal Selections 1	After restart
Pn50B	6543				Input Signal Selections 2	After restart
Pn50C	8888				Input Signal Selections 3	After restart
Pn50D	8888				Input Signal Selections 4	After restart
Pn50E	3211				Output Signal Selections 1	After restart
Pn50F	0000				Output Signal Selections 2	After restart
Pn510	0000				Output Signal Selections 3	After restart
Pn512	0000				Output Signal Inverse Settings	After restart
Pn513	0000				Output Signal Inverse Settings 2	After restart
Pn514	0000				Output Signal Selections 4	After restart
Pn515	8888				Input Signal Selections 6	After restart
Pn516	8888				Input Signal Selections 7	After restart
Pn517	0654				Output Signal Selections 5	After restart
Pn51B	1000				Motor-Load Position Deviation Overflow Detection Level	Immediately
Pn51E	100				Position Deviation Overflow Warning Level	Immediately
Pn520	5242880				Position Deviation Overflow Alarm Level	Immediately
Pn522	7				Positioning Completed Width	Immediately
Pn524	1073741824				Near Signal Width	Immediately
Pn526	5242880				Position Deviation Overflow Alarm Level at Servo ON	Immediately
Pn528	100				Position Deviation Overflow Warning Level at Servo ON	Immediately
Pn529	10000				Speed Limit Level at Servo ON	Immediately
Pn52A	20				Multiplier per Fully-closed Rotation	Immediately
Pn52B	20				Overload Warning Level	Immediately
Pn52C	100				Base Current Derating at Motor Overload Detection	After restart
Pn52D	50				Reserved parameter	–
Pn52F	OFFF				Monitor Display at Startup	Immediately
Pn530	0000				Program Jogging-Related Selections	Immediately
Pn531	32768				Program Jogging Travel Distance	Immediately
Pn533	500				Program Jogging Movement Speed	Immediately
Pn534	100				Program Jogging Acceleration/Deceleration Time	Immediately

Continued on next page.

5.1 SERVOPACKs with Analog Voltage/Pulse Train References

5.1.3 Parameter Recording Table

Continued from previous page.

Parameter No.	Default Setting					Name	When Enabled
Pn535	100					Program Jogging Waiting Time	Immediately
Pn536	1					Program Jogging Number of Movements	Immediately
Pn550	0					Analog Monitor 1 Offset Voltage	Immediately
Pn551	0					Analog Monitor 2 Offset Voltage	Immediately
Pn552	100					Analog Monitor 1 Magnification	Immediately
Pn553	100					Analog Monitor 2 Magnification	Immediately
Pn55A	1					Power Consumption Monitor Unit Time	Immediately
Pn560	400					Residual Vibration Detection Width	Immediately
Pn561	100					Overshoot Detection Level	Immediately
Pn580	10					Zero Clamping Level	Immediately
Pn581	20					Zero Speed Level	Immediately
Pn582	10					Speed Coincidence Detection Signal Output Width	Immediately
Pn583	10					Brake Reference Output Speed Level	Immediately
Pn584	10000					Speed Limit Level at Servo ON	Immediately
Pn585	50					Program Jogging Movement Speed	Immediately
Pn586	0					Motor Running Cooling Ratio	Immediately
Pn600	0					Regenerative Resistor Capacity	Immediately
Pn601	0					Dynamic Brake Resistor Allowable Energy Consumption	After restart
Pn603	0					Regenerative Resistance	Immediately
Pn604	0					Dynamic Brake Resistance	After restart

* The enable timing depends on the digit that is changed. Refer to the following section for details.

 5.1.2 List of Parameters on page 5-3

5.2 SERVOPACKs with MECHATROLINK-III Communications References

5.2.1 Interpreting the Parameter Lists

List of Servo Parameters

The types of motors to which the parameter applies.

- All: The parameter is used for both Rotary Servomotors and Linear Servomotors.
- Rotary: The parameter is used for only Rotary Servomotors.
- Linear: The parameter is used for only Linear Servomotors.

Rotary Servomotor terms are used for parameters that are applicable to all Servomotors. If you are using a Linear Servomotor, you need to interpret the terms accordingly. Refer to the following section for details.

◆ Differences in Terms for Rotary Servomotors and Linear Servomotors on page ix

“After restart” indicates parameters that will be effective after one of the following is executed.

- The power supply is turned OFF and ON again.
- The CONFIG command is sent.
- A software reset is executed.

Parameter No.	Size	Name	Setting Range	Setting Unit	Default Setting	Applicable Motors	When Enabled	Classification	Reference				
Pn000 M3	2	Basic Function Selections 0	0000 to 10B1	–	0000	All	After restart	Setup	–				
			<p>If there are differences in the parameters for Rotary Servomotor and Linear Servomotor, information is provided for both.</p> <ul style="list-style-type: none"> • Top row: For Rotary Servomotors • Bottom row: For Linear Servomotors 				<p>There are the following two classifications.</p> <ul style="list-style-type: none"> • Setup • Tuning <p>Refer to the following manual for details.</p> <p> Σ-7-Series Σ-7S SERVOPACK with MECHATROLINK-III Communications References Product Manual (Manual No.: SIEP S80001 28)</p>						
			<p>Rotation Direction Selection</p> <p>Movement Direction Selection</p>				Reference						
			n.□□□X	0	Use CCW as the forward direction.			–					
					Use the direction in which the linear encoder counts up as the forward direction.								
			n.X□□□	1	Use CW as the forward direction. (Reverse Rotation Mode)						–		
					Use the direction in which the linear encoder counts down as the forward direction. (Reverse Movement Mode)								
			<p>Symbols are provided when a parameter is valid only for a specific profile.</p> <ul style="list-style-type: none"> • M2 Parameters that are valid only for a MECHATROLINK-II-compatible profile. • M3 Parameters that are valid only for a MECHATROLINK-III standard servo profile. 										
			<p>Rotary/Linear Servomotor Startup Selection When Encoder Is Not Connected</p>				Reference						
			n.X□□□	0	When an encoder is not connected, start as SERVOPACK for Rotary Servomotor.			–					
		1		When an encoder is not connected, start as SERVOPACK for Linear Servomotor.									

List of MECHATROLINK-III Common Parameters

The types of motors to which the parameter applies.

- All: The parameter is used for both Rotary Servomotors and Linear Servomotors.
- Rotary: The parameter is used for only Rotary Servomotors.
- Linear: The parameter is used for only Linear Servomotors.

Rotary Servomotor terms are used for parameters that are applicable to all Servomotors. If you are using a Linear Servomotor, you need to interpret the terms accordingly. Refer to the following section for details.

 **Differences in Terms for Rotary Servomotors and Linear Servomotors on page ix**

Indicates when a change to the parameter will be effective.

“After restart” indicates parameters that will be effective after one of the following is executed.

- The power supply is turned OFF and ON again.
- The CONFIG command is sent.
- A software reset is executed.

Parameter No.	Size	Name	Setting Range	Setting Unit [Resolution]	Default Setting	Applicable Motors	When Enabled	Classification
61 PnAC2	4	Speed Loop Gain	1,000 to 2,000,000	0.001 Hz [0.1 Hz]	40000	All	Immediately	Tuning

You can set the parameter in increments of the setting unit. However, if a unit is given in square brackets, the setting is automatically converted to the resolution given in the square brackets.

5.2.2 List of Servo Parameters

The following table lists the parameters.

Note: Do not change the following parameters from their default settings.

- Reserved parameter
- Parameters not given in this manual
- Parameters that are not valid for the Servomotor that you are using, as given in the parameter table

Parameter No.	Size	Name	Setting Range	Setting Unit	Default Setting	Applicable Motors	When Enabled	Classification	Reference	
Pn000	2	Basic Function Selections 0	0000 to 10B1	–	0000	All	After restart	Setup	*1	
	n.□□□X	Rotation Direction Selection								
		Movement Direction Selection								
		0	Use CCW as the forward direction.							
			Use the direction in which the linear encoder counts up as the forward direction.							
	1	Use CW as the forward direction. (Reverse Rotation Mode)								
		Use the direction in which the linear encoder counts down as the forward direction. (Reverse Movement Mode)								
	n.□□X□	Reserved parameter (Do not change.)								
	n.□X□□	Reserved parameter (Do not change.)								
	n.X□□□	Rotary/Linear Servomotor Startup Selection When Encoder Is Not Connected								
0		When an encoder is not connected, start as SERVOPACK for Rotary Servomotor.								
1	When an encoder is not connected, start as SERVOPACK for Linear Servomotor.									

Continued on next page.

Continued from previous page.

Parameter No.	Size	Name	Setting Range	Setting Unit	Default Setting	Applicable Motors	When Enabled	Classification	Reference	
Pn001	2	Application Function Selections 1	0000 to 1142	–	0000	All	After restart	Setup	*1	
	n.□□□X	Motor Stopping Method for Servo OFF and Group 1 Alarms								
		0	Stop the motor by applying the dynamic brake.							
		1	Stop the motor by the applying dynamic brake and then release the dynamic brake.							
	n.□□X□	Overtravel Stopping Method								
		0	Apply the dynamic brake or coast the motor to a stop (use the stopping method set in Pn001 = n.□□□X).							
		1	Decelerate the motor to a stop using the torque set in Pn406 as the maximum torque and then servo-lock the motor.							
		2	Decelerate the motor to a stop using the torque set in Pn406 as the maximum torque and then let the motor coast.							
		3	Decelerate the motor to a stop using the deceleration time set in Pn30A and then servo-lock the motor.							
	n.□X□□	Main Circuit Power Supply AC/DC Input Selection								
		0	Input AC power as the main circuit power supply using the L1, L2, and L3 terminals (do not use shared converter).							
	n.X□□□	Reserved parameter (Do not change.)								

Continued on next page.

Continued from previous page.

Parameter No.	Size	Name	Setting Range	Setting Unit	Default Setting	Applicable Motors	When Enabled	Classification	Reference
Pn002	2	Application Function Selections 2	0000 to 4213	–	0011	–	After restart	Setup	–
	n.□□□X		MECHATROLINK Command Position and Speed Control Option				Applicable Motors	Reference	
	0	Reserved setting (Do not use.)				All	*2		
	1	Use TLIM as the torque limit.							
	2	Reserved setting (Do not use.)							
	3	Reserved setting (Do not use.)							
	n.□□X□		Torque Control Option				Applicable Motors	Reference	
	0	Reserved setting (Do not use.)				All	*2		
	1	Use the speed limit for torque control (VLIM) as the speed limit.							
	n.□X□□		Encoder Usage				Applicable Motors	Reference	
	0	Use the encoder according to encoder specifications.				All	*1		
	1	Use the encoder as an incremental encoder.							
	2	Use the encoder as a single-turn absolute encoder.							
	n.X□□□		External Encoder Usage				Applicable Motors	Reference	
	0	Do not use an external encoder.				Rotary	*1		
	1	The external encoder moves in the forward direction for CCW motor rotation.							
	2	Reserved setting (Do not use.)							
	3	The external encoder moves in the reverse direction for CCW motor rotation.							
	4	Reserved setting (Do not use.)							

Continued on next page.

Continued from previous page.

Parameter No.	Size	Name	Setting Range	Setting Unit	Default Setting	Applicable Motors	When Enabled	Classification	Reference		
Pn006	2	Application Function Selections 6	0000 to 105F	-	0002	All	Immediately	Setup	*1		
	n.□□XX	Analog Monitor 1 Signal Selection									
		00	Motor speed (1 V/1,000 min ⁻¹) Motor speed (1 V/1,000 mm/s)								
		01	Speed reference (1 V/1,000 min ⁻¹) Speed reference (1 V/1,000 mm/s)								
		02	Torque reference (1 V/100% rated torque) Force reference (1 V/100% rated force)								
		03	Position deviation (0.05 V/reference unit)								
		04	Position amplifier deviation (after electronic gear) (0.05 V/encoder pulse unit) Position amplifier deviation (after electronic gear) (0.05 V/linear encoder pulse unit)								
		05	Position reference speed (1 V/1,000 min ⁻¹) Position reference speed (1 V/1,000 mm/s)								
		06	Reserved setting (Do not use.)								
		07	Load-motor position deviation (0.01 V/reference unit)								
		08	Positioning completion (positioning completed: 5 V, positioning not completed: 0 V)								
		09	Speed feedforward (1 V/1,000 min ⁻¹) Speed feedforward (1 V/1,000 mm/s)								
		0A	Torque feedforward (1 V/100% rated torque) Force feedforward (1 V/100% rated force)								
		0B	Active gain (1st gain: 1 V, 2nd gain: 2 V)								
		0C	Completion of position reference distribution (completed: 5 V, not completed: 0 V)								
		0D	External encoder speed (1 V/1,000 min ⁻¹ : value at the motor shaft)								
		0E	Reserved setting (Do not use.)								
		0F	Reserved setting (Do not use.)								
		10	Main circuit DC voltage								
		11 to 24	Reserved settings (Do not use.)								
		25	Position deviation after position reference filter (0.05 V/reference unit)								
		26 to 5F	Reserved settings (Do not use.)								
		n.□X□□	Reserved parameter (Do not change.)								
		n.X□□□	Reserved parameter (Do not change.)								

Continued on next page.

Continued from previous page.

Parameter No.	Size	Name	Setting Range	Setting Unit	Default Setting	Applicable Motors	When Enabled	Classification	Reference		
Pn007	2	Application Function Selections 7	0000 to 105F	–	0000	All	Immediately	Setup	*1		
	n.□□XX	Analog Monitor 2 Signal Selection									
		00	Motor speed (1 V/1,000 min ⁻¹) Motor speed (1 V/1,000 mm/s)								
		01	Speed reference (1 V/1,000 min ⁻¹) Speed reference (1 V/1,000 mm/s)								
		02	Torque reference (1 V/100% rated torque) Force reference (1 V/100% rated force)								
		03	Position deviation (0.05 V/reference unit)								
		04	Position amplifier deviation (after electronic gear) (0.05 V/encoder pulse unit)								
			Position amplifier deviation (after electronic gear) (0.05 V/linear encoder pulse unit)								
		05	Position reference speed (1 V/1,000 min ⁻¹)								
			Position reference speed (1 V/1,000 mm/s)								
		06	Reserved setting (Do not use.)								
		07	Load-motor position deviation (0.01 V/reference unit)								
		08	Positioning completion (positioning completed: 5 V, positioning not completed: 0 V)								
		09	Speed feedforward (1 V/1,000 min ⁻¹)								
			Speed feedforward (1 V/1,000 mm/s)								
		0A	Torque feedforward (1 V/100% rated torque)								
			Force feedforward (1 V/100% rated force)								
		0B	Active gain (1st gain: 1 V, 2nd gain: 2 V)								
		0C	Completion of position reference distribution (completed: 5 V, not completed: 0 V)								
		0D	External encoder speed (1 V/1,000 min ⁻¹ : value at the motor shaft)								
		0E	Reserved setting (Do not use.)								
		0F	Reserved setting (Do not use.)								
		10	Main circuit DC voltage								
		11 to 24	Reserved settings (Do not use.)								
		25	Position deviation after position reference filter (0.05 V/reference unit)								
		26 to 5F	Reserved settings (Do not use.)								
		n.□X□□	Reserved parameter (Do not change.)								
		n.X□□□	Reserved parameter (Do not change.)								

Continued on next page.

Continued from previous page.

Parameter No.	Size	Name	Setting Range	Setting Unit	Default Setting	Applicable Motors	When Enabled	Classification	Reference	
Pn008	2	Application Function Selections 8	0000 to 7121	-	4000	Rotary	After restart	Setup	*1	
	n.□□□X		Low Battery Voltage Alarm/Warning Selection							
			0	Output alarm (A.830) for low battery voltage.						
			1	Output warning (A.930) for low battery voltage.						
	n.□□X□		Function Selection for Undervoltage							
			0	Do not detect undervoltage.						
			1	Detect undervoltage warning and limit torque at host controller.						
			2	Detect undervoltage warning and limit torque with Pn424 and Pn425 (i.e., only in SERVOPACK).						
	n.□X□□		Warning Detection Selection							
			0	Detect warnings.						
		1	Do not detect warnings except for A.971.							
n.X□□□		Reserved parameter (Do not change.)								
Pn009	2	Application Function Selections 9	0000 to 0121	-	0010	All	After restart	Tuning	*1	
	n.□□□X		Reserved parameter (Do not change.)							
	n.□□X□		Current Control Mode Selection							
			0	Use current control mode 1.						
			1	<ul style="list-style-type: none"> • SERVOPACK Models SGD7S-R70A, -R90A, -1R6A, -2R8A, -5R5A, and -7R6A: Use current control mode 1. • SERVOPACK Models SGD7S-120A, -180A, -200A, -330A, -470A, -550A, -590A, and -780A: Use current control mode 2. 						
			2	Use current control mode 2.						
	n.□X□□		Speed Detection Method Selection							
			0	Use speed detection 1.						
			1	Use speed detection 2.						
	n.X□□□		Reserved parameter (Do not change.)							

Continued on next page.

Continued from previous page.

Parameter No.	Size	Name	Setting Range	Setting Unit	Default Setting	Applicable Motors	When Enabled	Classification	Reference	
Pn00A	2	Application Function Selections A	0000 to 0044	–	0001	All	After restart	Setup	*1	
	n.□□□X	Motor Stopping Method for Group 2 Alarms		0	Apply the dynamic brake or coast the motor to a stop (use the stopping method set in Pn001 = n.□□□X).					
		1	Decelerate the motor to a stop using the torque set in Pn406 as the maximum torque. Use the setting of Pn001 = n.□□□X for the status after stopping.							
		2	Decelerate the motor to a stop using the torque set in Pn406 as the maximum torque and then let the motor coast.							
		3	Decelerate the motor to a stop using the deceleration time set in Pn30A. Use the setting of Pn001 = n.□□□X for the status after stopping.							
		4	Decelerate the motor to a stop using the deceleration time set in Pn30A and then let the motor coast.							
	n.□□X□	Stopping Method for Forced Stops		0	Apply the dynamic brake or coast the motor to a stop (use the stopping method set in Pn001 = n.□□□X).					
		1	Decelerate the motor to a stop using the torque set in Pn406 as the maximum torque. Use the setting of Pn001 = n.□□□X for the status after stopping.							
		2	Decelerate the motor to a stop using the torque set in Pn406 as the maximum torque and then let the motor coast.							
		3	Decelerate the motor to a stop using the deceleration time set in Pn30A. Use the setting of Pn001 = n.□□□X for the status after stopping.							
4		Decelerate the motor to a stop using the deceleration time set in Pn30A and then let the motor coast.								
n.□X□□	Reserved parameter (Do not change.)									
n.X□□□	Reserved parameter (Do not change.)									
Pn00B	2	Application Function Selections B	0000 to 1121	–	0000	All	After restart	Setup	*1	
	n.□□□X	Operator Parameter Display Selection		0	Display only setup parameters.					
		1	Display all parameters.							
	n.□□X□	Motor Stopping Method for Group 2 Alarms		0	Stop the motor by setting the speed reference to 0.					
		1	Apply the dynamic brake or coast the motor to a stop (use the stopping method set in Pn001 = n.□□□X).							
		2	Set the stopping method with Pn00A = n.□□□X.							
	n.□X□□	Power Input Selection for Three-phase SERVOPACK		0	Use a three-phase power supply input.					
		1	Use a three-phase power supply input as a single-phase power supply input.							
	n.X□□□	Reserved parameter (Do not change.)								

Continued on next page.

Continued from previous page.

Parameter No.	Size	Name	Setting Range	Setting Unit	Default Setting	Applicable Motors	When Enabled	Classification	Reference		
Pn00C	2	Application Function Selections C	0000 to 0131	-	0000	-	After restart	Setup	*1		
	n.□□□X		Function Selection for Test without a Motor						Applicable Motors		
			0	Disable tests without a motor.						All	
			1	Enable tests without a motor.							
	n.□□X□		Encoder Resolution for Tests without a Motor						Applicable Motors		
			0	Use 13 bits.						Rotary	
			1	Use 20 bits.							
			2	Use 22 bits.							
			3	Use 24 bits.							
	n.□X□□		Encoder Type Selection for Tests without a Motor						Applicable Motors		
		0	Use an incremental encoder.						All		
		1	Use an absolute encoder.								
n.X□□□		Reserved parameter (Do not change.)									
Pn00D	2	Application Function Selections D	0000 to 1001	-	0000	All	After restart	Setup	*1		
	n.□□□X		Reserved parameter (Do not change.)								
	n.□□X□		Reserved parameter (Do not change.)								
	n.□X□□		Reserved parameter (Do not change.)								
	n.X□□□		Overtravel Warning Detection Selection								
			0	Do not detect overtravel warnings.							
		1	Detect overtravel warnings.								
Pn00F	2	Application Function Selections F	0000 to 2011	-	0000	All	After restart	Setup	*1		
	n.□□□X		Preventative Maintenance Warning Selection								
			0	Do not detect preventative maintenance warnings.							
			1	Detect preventative maintenance warnings.							
	n.□□X□		Reserved parameter (Do not change.)								
	n.□X□□		Reserved parameter (Do not change.)								
	n.X□□□		Reserved parameter (Do not change.)								
Pn021	2	Reserved parameter (Do not change.)	-	-	0000	All	-	-	-		

Continued on next page.

Continued from previous page.

Parameter No.	Size	Name	Setting Range	Setting Unit	Default Setting	Applicable Motors	When Enabled	Classification	Reference		
Pn040	2	Σ-V Compatible Function Switch	0000 to 2111	–	0000	–	After restart	Setup	–		
	n.□□□X		Communications Interface Compatibility Selection						Applicable Motors		
			0	Perform Σ-7 communications.						All	
			1	Perform Σ-V communications.							
	n.□□X□		Encoder Resolution Compatibility Selection						Applicable Motors		
			0	Use the encoder resolution of the connected motor.						Rotary	
			1	Use a resolution of 20 bits when connected to an SGM7J, SGM7A, SGM7P, or SGM7G Servomotor.							
n.□X□□		Reserved parameter (Do not change.)									
n.X□□□		Reserved parameter (Do not change.)									
Pn080	2	Application Function Selections 80	0000 to 1111	–	0000	Linear	After restart	Setup	*1		
	n.□□□X		Polarity Sensor Selection								
			0	Use polarity sensor.							
			1	Do not use polarity sensor.							
	n.□□X□		Motor Phase Sequence Selection								
			0	Set a phase-A lead as a phase sequence of U, V, and W.							
			1	Set a phase-B lead as a phase sequence of U, V, and W.							
n.□X□□		Reserved parameter (Do not change.)									
n.X□□□		Calculation Method for Maximum Speed or Encoder Output Pulses									
		0	Calculate the encoder output pulse setting for a fixed maximum speed.								
		1	Calculate the maximum speed for a fixed encoder output pulse setting.								
Pn081	2	Application Function Selections 81	0000 to 1111	–	0000	All	After restart	Setup	*1		
	n.□□□X		Phase-C Pulse Output Selection								
			0	Output phase-C pulses only in the forward direction.							
			1	Output phase-C pulses in both the forward and reverse directions.							
	n.□□X□		Reserved parameter (Do not change.)								
	n.□X□□		Reserved parameter (Do not change.)								
n.X□□□		Reserved parameter (Do not change.)									
Pn100	2	Speed Loop Gain	10 to 20,000	0.1 Hz	400	All	Immediately	Tuning	*1		
Pn101	2	Speed Loop Integral Time Constant	15 to 51,200	0.01 ms	2000	All	Immediately	Tuning	*1		
Pn102	2	Position Loop Gain	10 to 20,000	0.1/s	400	All	Immediately	Tuning	*1		
Pn103	2	Moment of Inertia Ratio	0 to 20,000	1%	100	All	Immediately	Tuning	*1		
Pn104	2	Second Speed Loop Gain	10 to 20,000	0.1 Hz	400	All	Immediately	Tuning	*1		

Continued on next page.

Continued from previous page.

Parameter No.	Size	Name	Setting Range	Setting Unit	Default Setting	Applicable Motors	When Enabled	Classification	Reference	
Pn105	2	Second Speed Loop Integral Time Constant	15 to 51,200	0.01 ms	2000	All	Immediately	Tuning	*1	
Pn106	2	Second Position Loop Gain	10 to 20,000	0.1/s	400	All	Immediately	Tuning	*1	
Pn109	2	Feedforward	0 to 100	1%	0	All	Immediately	Tuning	*1	
Pn10A	2	Feedforward Filter Time Constant	0 to 6,400	0.01 ms	0	All	Immediately	Tuning	*1	
Pn10B	2	Gain Application Selections	0000 to 5334	-	0004	All	-	Setup	*1	
			Mode Switching Selection						When Enabled	
	n.□□□X		0	Use the internal torque reference as the condition (level setting: Pn10C).					Immediately	
			1	Use the speed reference as the condition (level setting: Pn10D). Use the speed reference as the condition (level setting: Pn181).						
			2	Use the acceleration reference as the condition (level setting: Pn10E).						
				Use the acceleration reference as the condition (level setting: Pn182).						
			3	Use the position deviation as the condition (level setting: Pn10F).						
			4	Do not use mode switching.						
			Speed Loop Control Method						When Enabled	
	n.□□X□		0	PI control					After restart	
		1	I-P control							
		2 to 3	Reserved settings (Do not use.)							
n.□X□□		Reserved parameter (Do not change.)								
n.X□□□		Reserved parameter (Do not change.)								
Pn10C	2	Mode Switching Level for Torque Reference	0 to 800	1%	200	All	Immediately	Tuning	*1	
Pn10D	2	Mode Switching Level for Speed Reference	0 to 10,000	1 min ⁻¹	0	Rotary	Immediately	Tuning	*1	
Pn10E	2	Mode Switching Level for Acceleration	0 to 30,000	1 min ⁻¹ /s	0	Rotary	Immediately	Tuning	*1	
Pn10F	2	Mode Switching Level for Position Deviation	0 to 10,000	1 reference unit	0	All	Immediately	Tuning	*1	
Pn11F	2	Position Integral Time Constant	0 to 50,000	0.1 ms	0	All	Immediately	Tuning	*1	
Pn121	2	Friction Compensation Gain	10 to 1,000	1%	100	All	Immediately	Tuning	*1	
Pn122	2	Second Friction Compensation Gain	10 to 1,000	1%	100	All	Immediately	Tuning	*1	
Pn123	2	Friction Compensation Coefficient	0 to 100	1%	0	All	Immediately	Tuning	*1	
Pn124	2	Friction Compensation Frequency Correction	-10,000 to 10,000	0.1 Hz	0	All	Immediately	Tuning	*1	
Pn125	2	Friction Compensation Gain Correction	1 to 1,000	1%	100	All	Immediately	Tuning	*1	
Pn131	2	Gain Switching Time 1	0 to 65,535	1 ms	0	All	Immediately	Tuning	*1	
Pn132	2	Gain Switching Time 2	0 to 65,535	1 ms	0	All	Immediately	Tuning	*1	
Pn135	2	Gain Switching Waiting Time 1	0 to 65,535	1 ms	0	All	Immediately	Tuning	*1	
Pn136	2	Gain Switching Waiting Time 2	0 to 65,535	1 ms	0	All	Immediately	Tuning	*1	

Continued on next page.

Continued from previous page.

Parameter No.	Size	Name	Setting Range	Setting Unit	Default Setting	Applicable Motors	When Enabled	Classification	Reference	
Pn139	2	Automatic Gain Switching Selections 1	0000 to 0052	–	0000	All	Immediately	Tuning	*1	
	n.□□□X		Gain Switching Selection							
			0	Use manual gain switching. The gain is switched manually with G-SEL in the servo command output signals (SVCMD_IO).						
			1	Reserved setting (Do not use.)						
			2	Use automatic gain switching pattern 1. The gain is switched automatically from the first gain to the second gain when switching condition A is satisfied. The gain is switched automatically from the second gain to the first gain when switching condition A is not satisfied.						
	n.□□X□		Gain Switching Condition A							
			0	/COIN (Positioning Completion Output) signal turns ON.						
			1	/COIN (Positioning Completion Output) signal turns OFF.						
			2	/NEAR (Near Output) signal turns ON.						
			3	/NEAR (Near Output) signal turns OFF.						
		4	Position reference filter output is 0 and position reference input is OFF.							
		5	Position reference input is ON.							
n.□X□□		Reserved parameter (Do not change.)								
n.X□□□		Reserved parameter (Do not change.)								
Pn13D	2	Current Gain Level	100 to 2,000	1%	2000	All	Immediately	Tuning	*1	
Pn13F	2	Less-Deviation Control 2 Second Position Integral Time Constant	0 to 50,000	0.1 ms	0	All	Immediately	Tuning	–	
Pn140	2	Model Following Control-Related Selections	0000 to 1121	–	0100	All	Immediately	Tuning	*1	
	n.□□□X		Model Following Control Selection							
			0	Do not use model following control.						
			1	Use model following control.						
	n.□□X□		Vibration Suppression Selection							
			0	Do not perform vibration suppression.						
			1	Perform vibration suppression for a specific frequency.						
			2	Perform vibration suppression for two specific frequencies.						
	n.□X□□		Vibration Suppression Adjustment Selection							
			0	Do not adjust vibration suppression automatically during execution of autotuning without a host reference, autotuning with a host reference, and custom tuning.						
		1	Adjust vibration suppression automatically during execution of autotuning without a host reference, autotuning with a host reference, and custom tuning.							
n.X□□□		Speed Feedforward (VFF)/Torque Feedforward (TFF) Selection								
		0	Do not use model following control and speed/torque feedforward together.							
		1	Use model following control and speed/torque feedforward together.							
Pn141	2	Model Following Control Gain	10 to 20,000	0.1/s	500	All	Immediately	Tuning	*1	
Pn142	2	Model Following Control Gain Correction	500 to 2,000	0.1%	1000	All	Immediately	Tuning	*1	

Continued on next page.

Continued from previous page.

Parameter No.	Size	Name	Setting Range	Setting Unit	Default Setting	Applicable Motors	When Enabled	Classification	Reference	
Pn143	2	Model Following Control Bias in the Forward Direction	0 to 10,000	0.1%	1000	All	Immediately	Tuning	*1	
Pn144	2	Model Following Control Bias in the Reverse Direction	0 to 10,000	0.1%	1000	All	Immediately	Tuning	*1	
Pn145	2	Vibration Suppression 1 Frequency A	10 to 2,500	0.1 Hz	500	All	Immediately	Tuning	*1	
Pn146	2	Vibration Suppression 1 Frequency B	10 to 2,500	0.1 Hz	700	All	Immediately	Tuning	*1	
Pn147	2	Model Following Control Speed Feedforward Compensation	0 to 10,000	0.1%	1000	All	Immediately	Tuning	*1	
Pn148	2	Second Model Following Control Gain	10 to 20,000	0.1/s	500	All	Immediately	Tuning	*1	
Pn149	2	Second Model Following Control Gain Correction	500 to 2,000	0.1%	1000	All	Immediately	Tuning	*1	
Pn14A	2	Vibration Suppression 2 Frequency	10 to 2,000	0.1 Hz	800	All	Immediately	Tuning	*1	
Pn14B	2	Vibration Suppression 2 Correction	10 to 1,000	1%	100	All	Immediately	Tuning	*1	
Pn14F	2	Control-Related Selections	0000 to 0021	-	0021	All	After restart	Tuning	*1	
		n.□□□X Model Following Control Type Selection								
		0	Use model following control type 1.							
		1	Use model following control type 2.							
		n.□□X□ Tuning-less Type Selection								
		0	Use tuning-less type 1.							
1	Use tuning-less type 2.									
2	Use tuning-less type 3.									
n.□X□□ Reserved parameter (Do not change.)										
n.X□□□ Reserved parameter (Do not change.)										
Pn160	2	Anti-Resonance Control-Related Selections	0000 to 0011	-	0010	All	Immediately	Tuning	*1	
		n.□□□X Anti-Resonance Control Selection								
		0	Do not use anti-resonance control.							
		1	Use anti-resonance control.							
		n.□□X□ Anti-Resonance Control Adjustment Selection								
		0	Do not adjust anti-resonance control automatically during execution of autotuning without a host reference, autotuning with a host reference, and custom tuning.							
1	Adjust anti-resonance control automatically during execution of autotuning without a host reference, autotuning with a host reference, and custom tuning.									
n.□X□□ Reserved parameter (Do not change.)										
n.X□□□ Reserved parameter (Do not change.)										
Pn161	2	Anti-Resonance Frequency	10 to 20,000	0.1 Hz	1000	All	Immediately	Tuning	*1	
Pn162	2	Anti-Resonance Gain Correction	1 to 1,000	1%	100	All	Immediately	Tuning	*1	

Continued on next page.

Continued from previous page.

Parameter No.	Size	Name	Setting Range	Setting Unit	Default Setting	Applicable Motors	When Enabled	Classification	Reference	
Pn163	2	Anti-Resonance Damping Gain	0 to 300	1%	0	All	Immediately	Tuning	*1	
Pn164	2	Anti-Resonance Filter Time Constant 1 Correction	-1,000 to 1,000	0.01 ms	0	All	Immediately	Tuning	*1	
Pn165	2	Anti-Resonance Filter Time Constant 2 Correction	-1,000 to 1,000	0.01 ms	0	All	Immediately	Tuning	*1	
Pn166	2	Anti-Resonance Damping Gain 2	0 to 1,000	1%	0	All	Immediately	Tuning	*1	
Pn170	2	Tuning-less Function-Related Selections	0000 to 2711	-	1400	All	-	Setup	*1	
	n.□□□X		Tuning-less Selection					When Enabled		
			0	Disable tuning-less function.				After restart		
			1	Enable tuning-less function.						
	n.□□X□		Speed Control Method					When Enabled		
			0	Use for speed control.				After restart		
			1	Use for speed control and use host controller for position control.						
	n.□X□□		Rigidity Level					When Enabled		
			0 to 7	Set the rigidity level.				Immediately		
	n.X□□□		Tuning-less Load Level					When Enabled		
		0 to 2	Set the load level for the tuning-less function.				Immediately			
Pn181	2	Mode Switching Level for Speed Reference	0 to 10,000	1 mm/s	0	Linear	Immediately	Tuning	*1	
Pn182	2	Mode Switching Level for Acceleration	0 to 30,000	1 mm/s ²	0	Linear	Immediately	Tuning	*1	
Pn190	2	Less-Deviation Control-Related Switches	0000 to 1101	-	0100	All	After restart	Setup	-	
	n.□□□X		Less-Deviation Control Selection							
			0	Do not use less-deviation control.						
			1	Use less-deviation control.						
	n.□□X□		Reserved parameter (Do not change.)							
	n.□X□□		Reserved parameter (Do not change.)							
Pn191	n.X□□□		Speed Feedforward/Torque Feedforward Selection							
			0	Less-deviation control and speed/torque feedforward are not used together.						
			1	Less-deviation control and speed/torque feedforward are used together.						
Pn191	2	Less-Deviation Control 1 Feedforward Gain	0 to 10,000	0.1%	1000	All	Immediately	Tuning	-	
Pn192	2	Less-Deviation Control 1 Second Feedforward Gain	0 to 10,000	0.1%	1000	All	Immediately	Tuning	-	
Pn193	2	Less-Deviation Control 1 Feedforward Filter Time Constant	0 to 65,535	0.01 ms	30	All	Immediately	Tuning	-	

Continued on next page.

Continued from previous page.

Parameter No.	Size	Name	Setting Range	Setting Unit	Default Setting	Applicable Motors	When Enabled	Classification	Reference	
Pn195	2	Less-Deviation Function Selection Switches	0000 to 2113	-	2102	All	After restart	Setup	-	
		n.□□□X	Reserved parameter (Do not change.)							
		n.□□X□	Reserved parameter (Do not change.)							
		n.□X□□	Reserved parameter (Do not change.)							
		n.X□□□	Less-Deviation Mode Selection							
			0	Use Less-Deviation Control 1 Mode when less-deviation control is enabled. (This mode is compatible with the Σ-V-series EX002.)						
	1		Reserved setting (Do not use.)							
		2	Use Less-Deviation Control 2 Mode when less-deviation control is enabled.							
Pn196	2	Less-Deviation Control 2 Speed Feedforward Gain	0 to 10,000	0.1%	1000	All	Immediately	Tuning	-	
Pn197	2	Less-Deviation Control 2 Torque Feedforward Filter Time Constant	0 to 65,535	0.01 ms	50	All	Immediately	Tuning	-	
Pn198	2	Less-Deviation Control 2 Forward Torque Feedforward Gain	0 to 10,000	0.1%	1000	All	Immediately	Tuning	-	
Pn199	2	Less-Deviation Control 2 Reverse Torque Feedforward Gain	0 to 10,000	0.1%	1000	All	Immediately	Tuning	-	
Pn19A	2	Less-Deviation Control 2 Incomplete Integration Rate	0 to 10,000	0.01%	10000	All	Immediately	Tuning	-	
Pn19B	2	Less-Deviation Control 2 Rotary Servomotor Viscous Friction Compensation Coefficient	0 to 8,000	0.01%/100 min ⁻¹	0	Rotary	Immediately	Tuning	-	
Pn19C	2	Reserved parameter (Do not change.)	-	-	0	All	Immediately	Tuning	-	
Pn19D	2	Less-Deviation Control 2 Linear Servomotor Viscous Friction Compensation Coefficient	0 to 8,000	0.01%/100 mm/s	0	Linear	Immediately	Tuning	-	
Pn19E	2	Reserved parameter (Do not change.)	-	-	0	All	Immediately	Tuning	-	
Pn19F	2	Less-Deviation Control 2 Torque Feedforward Moving Average Time	0 to 5,100	0.1 ms	0	All	Immediately	Tuning	-	
Pn1A4	2	Reserved parameter (Do not change.)	-	-	36	-	Immediately	Tuning	-	
Pn1A5	2	Reserved parameter (Do not change.)	-	-	0	-	Immediately	Tuning	-	
Pn1AE	2	Reserved parameter (Do not change.)	-	-	0	-	Immediately	Tuning	-	
Pn1AF	2	Reserved parameter (Do not change.)	-	-	0	-	Immediately	Tuning	-	
Pn205	2	Multiturn Limit	0 to 65,535	1 rev	65535	Rotary	After restart	Setup	*1	

Continued on next page.

5.2 SERVOPACKs with MECHATROLINK-III Communications References

5.2.2 List of Servo Parameters

Continued from previous page.

Parameter No.	Size	Name	Setting Range	Setting Unit	Default Setting	Applicable Motors	When Enabled	Classification	Reference	
Pn207	2	Position Control Function Selections	0000 to 2210	-	1000	All	After restart	Setup	*1	
		n.□□□X	Reserved parameter (Do not change.)							
		n.□□X□	Reserved parameter (Do not change.)							
		n.□X□□	Reserved parameter (Do not change.)							
		n.X□□□	/COIN (Positioning Completion Output) Signal Output Timing							
			0	Output when the absolute value of the position deviation is the same or less than the setting of Pn522 (Positioning Completed Width).						
	1		Output when the absolute value of the position error is the same or less than the setting of Pn522 (Positioning Completed Width) and the reference after the position reference filter is 0.							
	2	Output when the absolute value of the position error is the same or less than the setting of Pn522 (Positioning Completed Width) and the reference input is 0.								
Pn20A	4	Number of External Encoder Scale Pitches	4 to 1,048,576	1 scale pitch/revolution	32768	Rotary	After restart	Setup	*1	
Pn20E	4	Electronic Gear Ratio (Numerator)	1 to 1,073,741,824	1	16	All	After restart	Setup	*1	
Pn210	4	Electronic Gear Ratio (Denominator)	1 to 1,073,741,824	1	1	All	After restart	Setup	*1	
Pn212	4	Number of Encoder Output Pulses	16 to 1,073,741,824	1 P/Rev	2048	Rotary	After restart	Setup	*1	
Pn22A	2	Fully-closed Control Selections	0000 to 1003	-	0000	Rotary	After restart	Setup	*1	
		n.□□□X	Reserved parameter (Do not change.)							
		n.□□X□	Reserved parameter (Do not change.)							
		n.□X□□	Reserved parameter (Do not change.)							
		n.X□□□	Fully-closed Control Speed Feedback Selection							
			0	Use motor encoder speed.						
	1	Use external encoder speed.								
Pn230	2	Position Control Expansion Function Selections	0000 to 0001	-	0000	All	After restart	Setup	*1	
		n.□□□X	Backlash Compensation Direction							
			0	Compensate forward references.						
		1	Compensate reverse references.							
		n.□□X□	Reserved parameter (Do not change.)							
		n.□X□□	Reserved parameter (Do not change.)							
		n.X□□□	Reserved parameter (Do not change.)							
Pn231	4	Backlash Compensation	-500,000 to 500,000	0.1 reference units	0	All	Immediately	Setup	*1	
Pn233	2	Backlash Compensation Time Constant	0 to 65,535	0.01 ms	0	All	Immediately	Setup	*1	

Continued on next page.

Continued from previous page.

Parameter No.	Size	Name	Setting Range	Setting Unit	Default Setting	Applicable Motors	When Enabled	Classification	Reference		
Pn234	2	Second Position Reference Acceleration/Deceleration Time Constant	0 to 65,535	0.1 ms	0	All	Immediately	Setup	-		
Pn281	2	Encoder Output Resolution	1 to 4,096	1 edge/pitch	20	All	After restart	Setup	*1		
Pn282	4	Linear Encoder Scale Pitch	0 to 6,553,600	0.01 μ m	0	Linear	After restart	Setup	*1		
Pn304	2	Jogging Speed	0 to 10,000	Rotary: 1 min ⁻¹ Direct Drive: 0.1 min ⁻¹	500	Rotary	Immediately	Setup	*1		
Pn305	2	Soft Start Acceleration Time	0 to 10,000	1 ms	0	All	Immediately	Setup	*2		
Pn306	2	Soft Start Deceleration Time	0 to 10,000	1 ms	0	All	Immediately	Setup	*2		
Pn308	2	Speed Feedback Filter Time Constant	0 to 65,535	0.01 ms	0	All	Immediately	Setup	*1		
Pn30A	2	Deceleration Time for Servo OFF and Forced Stops	0 to 10,000	1 ms	0	All	Immediately	Setup	*1		
Pn30C	2	Speed Feedforward Average Movement Time	0 to 5,100	0.1 ms	0	All	Immediately	Setup	*1		
Pn310	2	Vibration Detection Selections	0000 to 0002	-	0000	All	Immediately	Setup	*1		
		n.□□□X		Vibration Detection Selection							
				0	Do not detect vibration.						
				1	Output a warning (A.911) if vibration is detected.						
				2	Output an alarm (A.520) if vibration is detected.						
		n.□□X□		Reserved parameter (Do not change.)							
n.□X□□		Reserved parameter (Do not change.)									
n.X□□□		Reserved parameter (Do not change.)									
Pn311	2	Vibration Detection Sensitivity	50 to 500	1%	100	All	Immediately	Tuning	*1		
Pn312	2	Vibration Detection Level	0 to 5,000	1 min ⁻¹	50	Rotary	Immediately	Tuning	*1		
Pn316	2	Maximum Motor Speed	0 to 65,535	1 min ⁻¹	10000	Rotary	After restart	Setup	*1		
Pn324	2	Moment of Inertia Calculation Starting Level	0 to 20,000	1%	300	All	Immediately	Setup	*1		
Pn383	2	Jogging Speed	0 to 10,000	1 mm/s	50	Linear	Immediately	Setup	*1		
Pn384	2	Vibration Detection Level	0 to 5,000	1 mm/s	10	Linear	Immediately	Tuning	*1		
Pn385	2	Maximum Motor Speed	1 to 100	100 mm/s	50	Linear	After restart	Setup	*1		
Pn401	2	First Stage First Torque Reference Filter Time Constant	0 to 65,535	0.01 ms	100	All	Immediately	Tuning	*1		
Pn402	2	Forward Torque Limit	0 to 800	1% ^{*3}	800	Rotary	Immediately	Setup	*1		
Pn403	2	Reverse Torque Limit	0 to 800	1% ^{*3}	800	Rotary	Immediately	Setup	*1		
Pn404	2	Forward External Torque Limit	0 to 800	1% ^{*3}	100	All	Immediately	Setup	*1		

Continued on next page.

Continued from previous page.

Parameter No.	Size	Name	Setting Range	Setting Unit	Default Setting	Applicable Motors	When Enabled	Classification	Reference	
Pn405	2	Reverse External Torque Limit	0 to 800	1%*3	100	All	Immediately	Setup	*1	
Pn406	2	Emergency Stop Torque	0 to 800	1%*3	800	All	Immediately	Setup	*1	
Pn407	2	Speed Limit during Torque Control	0 to 10,000	1 min ⁻¹	10000	Rotary	Immediately	Setup	*1	
Pn408	2	Torque-Related Function Selections	0000 to 1111	–	0000	All	–	Setup	*1	
	n.□□□X		Notch Filter Selection 1					When Enabled		
			0	Disable first stage notch filter.				Immediately		
			1	Enable first stage notch filter.						
	n.□□X□		Speed Limit Selection					When Enabled		
			0	Use the smaller of the maximum motor speed and the setting of Pn407 as the speed limit.				After restart		
				Use the smaller of the maximum motor speed and the setting of Pn480 as the speed limit.						
			1	Use the smaller of the overspeed alarm detection speed and the setting of Pn407 as the speed limit.						
				Use the smaller of the overspeed alarm detection speed and the setting of Pn480 as the speed limit.						
	n.□X□□		Notch Filter Selection 2					When Enabled		
		0	Disable second stage notch filter.				Immediately			
		1	Enable second stage notch filter.							
n.X□□□		Friction Compensation Function Selection					When Enabled			
		0	Disable friction compensation.				Immediately			
		1	Enable friction compensation.							
Pn409	2	First Stage Notch Filter Frequency	50 to 5,000	1 Hz	5000	All	Immediately	Tuning	*1	
Pn40A	2	First Stage Notch Filter Q Value	50 to 1,000	0.01	70	All	Immediately	Tuning	*1	
Pn40B	2	First Stage Notch Filter Depth	0 to 1,000	0.001	0	All	Immediately	Tuning	*1	
Pn40C	2	Second Stage Notch Filter Frequency	50 to 5,000	1 Hz	5000	All	Immediately	Tuning	*1	
Pn40D	2	Second Stage Notch Filter Q Value	50 to 1,000	0.01	70	All	Immediately	Tuning	*1	
Pn40E	2	Second Stage Notch Filter Depth	0 to 1,000	0.001	0	All	Immediately	Tuning	*1	
Pn40F	2	Second Stage Second Torque Reference Filter Frequency	100 to 5,000	1 Hz	5000	All	Immediately	Tuning	*1	
Pn410	2	Second Stage Second Notch Filter Q Value	50 to 100	0.01	50	All	Immediately	Tuning	*1	
Pn412	2	First Stage Second Torque Reference Filter Time Constant	0 to 65,535	0.01 ms	100	All	Immediately	Tuning	*1	

Continued on next page.

Continued from previous page.

Parameter No.	Size	Name	Setting Range	Setting Unit	Default Setting	Applicable Motors	When Enabled	Classification	Reference
Pn416	2	Torque-Related Function Selections 2	0000 to 1111	-	0000	All	Immediately	Setup	*1
	n.□□□X	Notch Filter Selection 3							
		0	Disable third stage notch filter.						
	n.□□X□	Notch Filter Selection 4							
		0	Disable fourth stage notch filter.						
	n.□X□□	Notch Filter Selection 5							
		0	Disable fifth stage notch filter.						
	n.X□□□	Reserved parameter (Do not change.)							
		2	Third Stage Notch Filter Frequency	50 to 5,000	1 Hz	5000	All	Immediately	Tuning
	Pn418	2	Third Stage Notch Filter Q Value	50 to 1,000	0.01	70	All	Immediately	Tuning
Pn419	2	Third Stage Notch Filter Depth	0 to 1,000	0.001	0	All	Immediately	Tuning	*1
Pn41A	2	Fourth Stage Notch Filter Frequency	50 to 5,000	1 Hz	5000	All	Immediately	Tuning	*1
Pn41B	2	Fourth Stage Notch Filter Q Value	50 to 1,000	0.01	70	All	Immediately	Tuning	*1
Pn41C	2	Fourth Stage Notch Filter Depth	0 to 1,000	0.001	0	All	Immediately	Tuning	*1
Pn41D	2	Fifth Stage Notch Filter Frequency	50 to 5,000	1 Hz	5000	All	Immediately	Tuning	*1
Pn41E	2	Fifth Stage Notch Filter Q Value	50 to 1,000	0.01	70	All	Immediately	Tuning	*1
Pn41F	2	Fifth Stage Notch Filter Depth	0 to 1,000	0.001	0	All	Immediately	Tuning	*1
Pn423	2	Speed Ripple Compensation Selections	0000 to 1111	-	0000	Rotary	-	Setup	*1
	n.□□□X	Speed Ripple Compensation Function Selection							When Enabled
		0	Disable speed ripple compensation.						
	n.□□X□	Speed Ripple Compensation Information Disagreement Warning Detection Selection							When Enabled
		0	Detect A.942 alarms.						
	n.□X□□	Speed Ripple Compensation Enable Condition Selection							When Enabled
0		Speed reference							After restart
n.X□□□	Reserved parameter (Do not change.)								
	Pn424	2	Torque Limit at Main Circuit Voltage Drop	0 to 100	1%*2	50	All	Immediately	Setup

Continued on next page.

Continued from previous page.

Parameter No.	Size	Name	Setting Range	Setting Unit	Default Setting	Applicable Motors	When Enabled	Classification	Reference
Pn425	2	Release Time for Torque Limit at Main Circuit Voltage Drop	0 to 1,000	1 ms	100	All	Immediately	Setup	*1
Pn426	2	Torque Feedforward Average Movement Time	0 to 5,100	0.1 ms	0	All	Immediately	Setup	*1
Pn427	2	Speed Ripple Compensation Enable Speed	0 to 10,000	1 min ⁻¹	0	Rotary Servomotor	Immediately	Tuning	*1
Pn456	2	Sweep Torque Reference Amplitude	1 to 800	1%	15	All	Immediately	Tuning	*1
Pn460	2	Notch Filter Adjustment Selections 1	0000 to 0101	–	0101	All	Immediately	Tuning	*1
	n.□□□X		Notch Filter Adjustment Selection 1						
		0	Do not adjust the first stage notch filter automatically during execution of autotuning without a host reference, autotuning with a host reference, and custom tuning.						
		1	Adjust the first stage notch filter automatically during execution of autotuning without a host reference, autotuning with a host reference, and custom tuning.						
	n.□□X□		Reserved parameter (Do not change.)						
	n.□X□□		Notch Filter Adjustment Selection 2						
	0	Do not adjust the second stage notch filter automatically during execution of autotuning without a host reference, autotuning with a host reference, and custom tuning.							
	1	Adjust the second stage notch filter automatically during execution of autotuning without a host reference, autotuning with a host reference, and custom tuning.							
n.X□□□		Reserved parameter (Do not change.)							
Pn480	2	Speed Limit during Force Control	0 to 10,000	1 mm/s	10000	Linear	Immediately	Setup	*1
Pn481	2	Polarity Detection Speed Loop Gain	10 to 20,000	0.1 Hz	400	Linear	Immediately	Tuning	–
Pn482	2	Polarity Detection Speed Loop Integral Time Constant	15 to 51,200	0.01 ms	3000	Linear	Immediately	Tuning	–
Pn483	2	Forward Force Limit	0 to 800	1% ^{*3}	30	Linear	Immediately	Setup	*1
Pn484	2	Reverse Force Limit	0 to 800	1% ^{*3}	30	Linear	Immediately	Setup	*1
Pn485	2	Polarity Detection Reference Speed	0 to 100	1 mm/s	20	Linear	Immediately	Tuning	–
Pn486	2	Polarity Detection Reference Acceleration/Deceleration Time	0 to 100	1 ms	25	Linear	Immediately	Tuning	–
Pn487	2	Polarity Detection Constant Speed Time	0 to 300	1 ms	0	Linear	Immediately	Tuning	–
Pn488	2	Polarity Detection Reference Waiting Time	50 to 500	1 ms	100	Linear	Immediately	Tuning	–
Pn48E	2	Polarity Detection Range	1 to 65,535	1 mm	10	Linear	Immediately	Tuning	–
Pn490	2	Polarity Detection Load Level	0 to 20,000	1%	100	Linear	Immediately	Tuning	–
Pn495	2	Polarity Detection Confirmation Force Reference	0 to 200	1%	100	Linear	Immediately	Tuning	–
Pn498	2	Polarity Detection Allowable Error Range	0 to 30	1 deg	10	Linear	Immediately	Tuning	–
Pn49F	2	Speed Ripple Compensation Enable Speed	0 to 10,000	1 mm/s	0	Linear	Immediately	Tuning	*1

Continued on next page.

Continued from previous page.

Parameter No.	Size	Name	Setting Range	Setting Unit	Default Setting	Applicable Motors	When Enabled	Classification	Reference		
Pn502	2	Rotation Detection Level	1 to 10,000	1 min ⁻¹	20	Rotary	Immediately	Setup	*1		
Pn503	2	Speed Coincidence Detection Signal Output Width	0 to 100	1 min ⁻¹	10	Rotary	Immediately	Setup	*1		
Pn506	2	Brake Reference-Servo OFF Delay Time	0 to 50	10 ms	0	All	Immediately	Setup	*1		
Pn507	2	Brake Reference Output Speed Level	0 to 10,000	1 min ⁻¹	100	Rotary	Immediately	Setup	*1		
Pn508	2	Servo OFF-Brake Command Waiting Time	10 to 100	10 ms	50	All	Immediately	Setup	*1		
Pn509	2	Momentary Power Interruption Hold Time	20 to 50,000	1 ms	20	All	Immediately	Setup	*1		
Pn50A	2	Input Signal Selections 1	0000 to FFF2	-	1881	All	After restart	Setup	*1		
	n.□□□X		Reserved parameter (Do not change.)								
	n.□□X□		Reserved parameter (Do not change.)								
	n.□X□□		Reserved parameter (Do not change.)								
			P-OT (Forward Drive Prohibit) Signal Allocation								
			0	Enable forward drive when CN1-13 input signal is ON (closed).							
			1	Enable forward drive when CN1-7 input signal is ON (closed).							
			2	Enable forward drive when CN1-8 input signal is ON (closed).							
			3	Enable forward drive when CN1-9 input signal is ON (closed).							
			4	Enable forward drive when CN1-10 input signal is ON (closed).							
			5	Enable forward drive when CN1-11 input signal is ON (closed).							
			6	Enable forward drive when CN1-12 input signal is ON (closed).							
			7	Set the signal to always prohibit forward drive.							
			8	Set the signal to always enable forward drive.							
			9	Enable forward drive when CN1-13 input signal is OFF (open).							
		A	Enable forward drive when CN1-7 input signal is OFF (open).								
		B	Enable forward drive when CN1-8 input signal is OFF (open).								
		C	Enable forward drive when CN1-9 input signal is OFF (open).								
		D	Enable forward drive when CN1-10 input signal is OFF (open).								
		E	Enable forward drive when CN1-11 input signal is OFF (open).								
		F	Enable forward drive when CN1-12 input signal is OFF (open).								

Continued on next page.

Continued from previous page.

Parameter No.	Size	Name	Setting Range	Setting Unit	Default Setting	Applicable Motors	When Enabled	Classification	Reference	
Pn50B	2	Input Signal Selections 2	0000 to FFFF	–	8882	All	After restart	Setup	*1	
	n.□□□X N-OT (Reverse Drive Prohibit) Signal Allocation									
	0		Enable reverse drive when CN1-13 input signal is ON (closed).							
	1		Enable reverse drive when CN1-7 input signal is ON (closed).							
	2		Enable reverse drive when CN1-8 input signal is ON (closed).							
	3		Enable reverse drive when CN1-9 input signal is ON (closed).							
	4		Enable reverse drive when CN1-10 input signal is ON (closed).							
	5		Enable reverse drive when CN1-11 input signal is ON (closed).							
	6		Enable reverse drive when CN1-12 input signal is ON (closed).							
	7		Set the signal to always prohibit reverse drive.							
	8		Set the signal to always enable reverse drive.							
	9		Enable reverse drive when CN1-13 input signal is OFF (open).							
	A		Enable reverse drive when CN1-7 input signal is OFF (open).							
	B		Enable reverse drive when CN1-8 input signal is OFF (open).							
	C		Enable reverse drive when CN1-9 input signal is OFF (open).							
	D		Enable reverse drive when CN1-10 input signal is OFF (open).							
	E		Enable reverse drive when CN1-11 input signal is OFF (open).							
	F		Enable reverse drive when CN1-12 input signal is OFF (open).							
	n.□□X□ Reserved parameter (Do not change.)									
	n.□X□□ /P-CL (Forward External Torque Limit Input) Signal Allocation									
	0		Active when CN1-13 input signal is ON (closed).							
	1		Active when CN1-7 input signal is ON (closed).							
	2		Active when CN1-8 input signal is ON (closed).							
	3		Active when CN1-9 input signal is ON (closed).							
	4		Active when CN1-10 input signal is ON (closed).							
	5		Active when CN1-11 input signal is ON (closed).							
	6		Active when CN1-12 input signal is ON (closed).							
	7		The signal is always active.							
	8		The signal is always inactive.							
	9		Active when CN1-13 input signal is OFF (open).							
	A		Active when CN1-7 input signal is OFF (open).							
	B		Active when CN1-8 input signal is OFF (open).							
	C		Active when CN1-9 input signal is OFF (open).							
	D		Active when CN1-10 input signal is OFF (open).							
	E		Active when CN1-11 input signal is OFF (open).							
	F		Active when CN1-12 input signal is OFF (open).							
	n.X□□□ /N-CL (Reverse External Torque Limit Input) Signal Allocation									
	0 to F		The allocations are the same as the /P-CL (Forward External Torque Limit Input) signal allocations.							

Continued on next page.

Continued from previous page.

Parameter No.	Size	Name	Setting Range	Setting Unit	Default Setting	Applicable Motors	When Enabled	Classification	Reference		
Pn50E	2	Output Signal Selections 1	0000 to 6666	–	0000	All	After restart	Setup	*1		
	n.□□□X	/COIN (Positioning Completion Output) Signal Allocation									
		0	Disabled (the above signal output is not used).								
		1	Output the signal from the CN1-1 or CN1-2 output terminal.								
		2	Output the signal from the CN1-23 or CN1-24 output terminal.								
		3	Output the signal from the CN1-25 or CN1-26 output terminal.								
	4 to 6	Reserved setting (Do not use.)									
	n.□□X□	/V-CMP (Speed Coincidence Detection Output) Signal Allocation									
		0 to 6	The allocations are the same as the /COIN (Positioning Completion) signal allocations.								
	n.□X□□	/TGON (Rotation Detection Output) Signal Allocation									
		0 to 6	The allocations are the same as the /COIN (Positioning Completion) signal allocations.								
	n.X□□□	/S-RDY (Servo Ready) Signal Allocation									
		0 to 6	The allocations are the same as the /COIN (Positioning Completion) signal allocations.								
	Pn50F	2	Output Signal Selections 2	0000 to 6666	–	0100	All	After restart	Setup	*1	
		n.□□□X	/CLT (Torque Limit Detection Output) Signal Allocation								
			0	Disabled (the above signal output is not used).							
1			Output the signal from the CN1-1 or CN1-2 output terminal.								
2			Output the signal from the CN1-23 or CN1-24 output terminal.								
3			Output the signal from the CN1-25 or CN1-26 output terminal.								
4 to 6		Reserved setting (Do not use.)									
n.□□X□		/VLT (Speed Limit Detection) Signal Allocation									
		0 to 6	The allocations are the same as the /CLT (Torque Limit Detection Output) signal allocations.								
n.□X□□		/BK (Brake Output) Signal Allocation									
		0 to 6	The allocations are the same as the /CLT (Torque Limit Detection Output) signal allocations.								
n.X□□□		/WARN (Warning Output) Signal Allocation									
		0 to 6	The allocations are the same as the /CLT (Torque Limit Detection Output) signal allocations.								

Continued on next page.

Continued from previous page.

Parameter No.	Size	Name	Setting Range	Setting Unit	Default Setting	Applicable Motors	When Enabled	Classification	Reference	
Pn510	2	Output Signal Selections 3	0000 to 0666	-	0000	All	After restart	Setup	*1	
	n.□□□X	/NEAR (Near Output) Signal Allocation								
		0	Disabled (the above signal output is not used).							
		1	Output the signal from the CN1-1 or CN1-2 output terminal.							
		2	Output the signal from the CN1-23 or CN1-24 output terminal.							
		3	Output the signal from the CN1-25 or CN1-26 output terminal.							
	4 to 6	Reserved setting (Do not use.)								
	n.□□X□	Reserved parameter (Do not change.)								
	n.□X□□	Reserved parameter (Do not change.)								
	n.X□□□	Reserved parameter (Do not change.)								
Pn511	2	Input Signal Selections 5	0000 to FFFF	-	6543	All	After restart	Setup	*1	
	n.□□□X	/DEC (Origin Return Deceleration Switch Input) Signal Allocation								
		0	Active when CN1-13 input signal is ON (closed).							
		1	Active when CN1-7 input signal is ON (closed).							
		2	Active when CN1-8 input signal is ON (closed).							
		3	Active when CN1-9 input signal is ON (closed).							
		4	Active when CN1-10 input signal is ON (closed).							
		5	Active when CN1-11 input signal is ON (closed).							
		6	Active when CN1-12 input signal is ON (closed).							
		7	The signal is always active.							
		8	The signal is always inactive.							
		9	Active when CN1-13 input signal is OFF (open).							
		A	Active when CN1-7 input signal is OFF (open).							
		B	Active when CN1-8 input signal is OFF (open).							
		C	Active when CN1-9 input signal is OFF (open).							
		D	Active when CN1-10 input signal is OFF (open).							
	E	Active when CN1-11 input signal is OFF (open).								
	F	Active when CN1-12 input signal is OFF (open).								
	n.□□X□	/EXT1 (External Latch Input 1) Signal Allocation								
		0 to 3	The signal is always inactive.							
		4	Active when CN1-10 input signal is ON (closed).							
		5	Active when CN1-11 input signal is ON (closed).							
		6	Active when CN1-12 input signal is ON (closed).							
		D	Active when CN1-10 input signal is OFF (open).							
		E	Active when CN1-11 input signal is OFF (open).							
	F	Active when CN1-12 input signal is OFF (open).								
	7 to C	The signal is always inactive.								
	n.□X□□	/EXT2 (External Latch Input 2) Signal Allocation								
0 to F		The allocations are the same as the /EXT1 (External Latch Input 1) signal allocations.								
n.X□□□	/EXT3 (External Latch Input 3) Signal Allocation									
	0 to F	The allocations are the same as the /EXT1 (External Latch Input 1) signal allocations.								

Continued on next page.

Continued from previous page.

Parameter No.	Size	Name	Setting Range	Setting Unit	Default Setting	Applicable Motors	When Enabled	Classification	Reference		
Pn512	2	Output Signal Inverse Settings	0000 to 1111	-	0000	All	After restart	Setup	*1		
	n.□□□X		Output Signal Inversion for CN1-1 and CN1-2 Terminals								
			0	The signal is not inverted.							
			1	The signal is inverted.							
	n.□□X□		Output Signal Inversion for CN1-23 and CN1-24 Terminals								
			0	The signal is not inverted.							
			1	The signal is inverted.							
	n.□X□□		Output Signal Inversion for CN1-25 and CN1-26 Terminals								
			0	The signal is not inverted.							
			1	The signal is inverted.							
	n.X□□□		Reserved parameter (Do not change.)								
	Pn514	2	Output Signal Selections 4	0000 to 0666	-	0000	All	After restart	Setup	*1	
		n.□□□X		Reserved parameter (Do not change.)							
		n.□□X□		Reserved parameter (Do not change.)							
		n.□X□□		/PM (Preventative Maintenance Output) Signal Allocation							
		0	Disabled (the above signal output is not used).								
		1	Output the signal from the CN1-1 or CN1-2 output terminal.								
		2	Output the signal from the CN1-23 or CN1-24 output terminal.								
		3	Output the signal from the CN1-25 or CN1-26 output terminal.								
		4 to 6	Reserved setting (Do not use.)								
n.X□□□		Reserved parameter (Do not change.)									

Continued on next page.

Continued from previous page.

Parameter No.	Size	Name	Setting Range	Setting Unit	Default Setting	Applicable Motors	When Enabled	Classification	Reference	
Pn516	2	Input Signal Selections 7	0000 to FFFF	-	8888	All	After restart	Setup	*1	
	n.□□□X		FSTP (Forced Stop Input) Signal Allocation							
			0	Enable drive when CN1-13 input signal is ON (closed).						
			1	Enable drive when CN1-7 input signal is ON (closed).						
			2	Enable drive when CN1-8 input signal is ON (closed).						
			3	Enable drive when CN1-9 input signal is ON (closed).						
			4	Enable drive when CN1-10 input signal is ON (closed).						
			5	Enable drive when CN1-11 input signal is ON (closed).						
			6	Enable drive when CN1-12 input signal is ON (closed).						
			7	Set the signal to always prohibit drive (always force the motor to stop).						
			8	Set the signal to always enable drive (always disable forcing the motor to stop).						
			9	Enable drive when CN1-13 input signal is OFF (open).						
			A	Enable drive when CN1-7 input signal is OFF (open).						
			B	Enable drive when CN1-8 input signal is OFF (open).						
			C	Enable drive when CN1-9 input signal is OFF (open).						
			D	Enable drive when CN1-10 input signal is OFF (open).						
			E	Enable drive when CN1-11 input signal is OFF (open).						
			F	Enable drive when CN1-12 input signal is OFF (open).						
	n.□□X□		Reserved parameter (Do not change.)							
	n.□X□□		Reserved parameter (Do not change.)							
n.X□□□		Reserved parameter (Do not change.)								
Pn518*3	-	Safety Module-Related Parameters	-	-	-	All	-	-	-	
Pn51B	4	Motor-Load Position Deviation Overflow Detection Level	0 to 1,073,741,824	1 reference unit	1000	Rotary	Immediately	Setup	*1	
Pn51E	2	Position Deviation Overflow Warning Level	10 to 100	1%	100	All	Immediately	Setup	*1	
Pn520	4	Position Deviation Overflow Alarm Level	1 to 1,073,741,823	1 reference unit	5242880	All	Immediately	Setup	*1	
Pn522	4	Positioning Completed Width	0 to 1,073,741,824	1 reference unit	7	All	Immediately	Setup	*1	
Pn524	4	Near Signal Width	1 to 1,073,741,824	1 reference unit	1073741824	All	Immediately	Setup	*1	
Pn526	4	Position Deviation Overflow Alarm Level at Servo ON	1 to 1,073,741,823	1 reference unit	5242880	All	Immediately	Setup	*1	
Pn528	2	Position Deviation Overflow Warning Level at Servo ON	10 to 100	1%	100	All	Immediately	Setup	*1	
Pn529	2	Speed Limit Level at Servo ON	0 to 10,000	1 min ⁻¹	10000	Rotary	Immediately	Setup	*1	
Pn52A	2	Multiplier per Fully-closed Rotation	0 to 100	1%	20	Rotary	Immediately	Tuning	*1	
Pn52B	2	Overload Warning Level	1 to 100	1%	20	All	Immediately	Setup	*1	

Continued on next page.

Continued from previous page.

Parameter No.	Size	Name	Setting Range	Setting Unit	Default Setting	Applicable Motors	When Enabled	Classification	Reference															
Pn52C	2	Base Current Derating at Motor Overload Detection	10 to 100	1%	100	All	After restart	Setup	*1															
Pn52D	2	Reserved parameter (Do not change.)	–	–	50	All	–	–	–															
Pn530	2	Program Jogging-Related Selections	0000 to 0005	–	0000	All	Immediately	Setup	*1															
			<table border="1"> <thead> <tr> <th colspan="2">Program Jogging Operation Pattern</th> </tr> </thead> <tbody> <tr> <td>0</td> <td>(Waiting time in Pn535 → Forward by travel distance in Pn531) × Number of movements in Pn536</td> </tr> <tr> <td>1</td> <td>(Waiting time in Pn535 → Reverse by travel distance in Pn531) × Number of movements in Pn536</td> </tr> <tr> <td>2</td> <td>(Waiting time in Pn535 → Forward by travel distance in Pn531) × Number of movements in Pn536 (Waiting time in Pn535 → Reverse by travel distance in Pn531) × Number of movements in Pn536</td> </tr> <tr> <td>3</td> <td>(Waiting time in Pn535 → Reverse by travel distance in Pn531) × Number of movements in Pn536 (Waiting time in Pn535 → Forward by travel distance in Pn531) × Number of movements in Pn536</td> </tr> <tr> <td>4</td> <td>(Waiting time in Pn535 → Forward by travel distance in Pn531 → Waiting time in Pn535 → Reserve by travel distance in Pn531) × Number of movements in Pn536</td> </tr> <tr> <td>5</td> <td>(Waiting time in Pn535 → Reverse by travel distance in Pn531 → Waiting time in Pn535 → Forward by travel distance in Pn531) × Number of movements in Pn536</td> </tr> </tbody> </table>								Program Jogging Operation Pattern		0	(Waiting time in Pn535 → Forward by travel distance in Pn531) × Number of movements in Pn536	1	(Waiting time in Pn535 → Reverse by travel distance in Pn531) × Number of movements in Pn536	2	(Waiting time in Pn535 → Forward by travel distance in Pn531) × Number of movements in Pn536 (Waiting time in Pn535 → Reverse by travel distance in Pn531) × Number of movements in Pn536	3	(Waiting time in Pn535 → Reverse by travel distance in Pn531) × Number of movements in Pn536 (Waiting time in Pn535 → Forward by travel distance in Pn531) × Number of movements in Pn536	4	(Waiting time in Pn535 → Forward by travel distance in Pn531 → Waiting time in Pn535 → Reserve by travel distance in Pn531) × Number of movements in Pn536	5	(Waiting time in Pn535 → Reverse by travel distance in Pn531 → Waiting time in Pn535 → Forward by travel distance in Pn531) × Number of movements in Pn536
	Program Jogging Operation Pattern																							
	0	(Waiting time in Pn535 → Forward by travel distance in Pn531) × Number of movements in Pn536																						
	1	(Waiting time in Pn535 → Reverse by travel distance in Pn531) × Number of movements in Pn536																						
	2	(Waiting time in Pn535 → Forward by travel distance in Pn531) × Number of movements in Pn536 (Waiting time in Pn535 → Reverse by travel distance in Pn531) × Number of movements in Pn536																						
	3	(Waiting time in Pn535 → Reverse by travel distance in Pn531) × Number of movements in Pn536 (Waiting time in Pn535 → Forward by travel distance in Pn531) × Number of movements in Pn536																						
	4	(Waiting time in Pn535 → Forward by travel distance in Pn531 → Waiting time in Pn535 → Reserve by travel distance in Pn531) × Number of movements in Pn536																						
	5	(Waiting time in Pn535 → Reverse by travel distance in Pn531 → Waiting time in Pn535 → Forward by travel distance in Pn531) × Number of movements in Pn536																						
	n.□□□X		Reserved parameter (Do not change.)																					
n.□X□□		Reserved parameter (Do not change.)																						
n.X□□□		Reserved parameter (Do not change.)																						
Pn531	4	Program Jogging Travel Distance	1 to 1,073,741,824	1 reference unit	32768	All	Immediately	Setup	*1															
Pn533	2	Program Jogging Movement Speed	1 to 10,000	Rotary: 1 min ⁻¹ Direct Drive: 0.1 min ⁻¹	500	Rotary	Immediately	Setup	*1															
Pn534	2	Program Jogging Acceleration/Deceleration Time	2 to 10,000	1 ms	100	All	Immediately	Setup	*1															
Pn535	2	Program Jogging Waiting Time	0 to 10,000	1 ms	100	All	Immediately	Setup	*1															
Pn536	2	Program Jogging Number of Movements	0 to 1,000	Times	1	All	Immediately	Setup	*1															
Pn550	2	Analog Monitor 1 Offset Voltage	-10,000 to 10,000	0.1 V	0	All	Immediately	Setup	*1															
Pn551	2	Analog Monitor 2 Offset Voltage	-10,000 to 10,000	0.1 V	0	All	Immediately	Setup	*1															
Pn552	2	Analog Monitor 1 Magnification	-10,000 to 10,000	× 0.01	100	All	Immediately	Setup	*1															
Pn553	2	Analog Monitor 2 Magnification	-10,000 to 10,000	× 0.01	100	All	Immediately	Setup	*1															
Pn55A	2	Power Consumption Monitor Unit Time	1 to 1,440	1 min	1	All	Immediately	Setup	–															
Pn560	2	Residual Vibration Detection Width	1 to 3,000	0.1%	400	All	Immediately	Setup	*1															
Pn561	2	Overshoot Detection Level	0 to 100	1%	100	All	Immediately	Setup	*1															

Continued on next page.

5.2 SERVOPACKs with MECHATROLINK-III Communications References

5.2.2 List of Servo Parameters

Continued from previous page.

Parameter No.	Size	Name	Setting Range	Setting Unit	Default Setting	Applicable Motors	When Enabled	Classification	Reference									
Pn581	2	Zero Speed Level	1 to 10,000	1 mm/s	20	Linear	Immediately	Setup	*1									
Pn582	2	Speed Coincidence Detection Signal Output Width	0 to 100	1 mm/s	10	Linear	Immediately	Setup	*1									
Pn583	2	Brake Reference Output Speed Level	0 to 10,000	1 mm/s	10	Linear	Immediately	Setup	*1									
Pn584	2	Speed Limit Level at Servo ON	0 to 10,000	1 mm/s	10000	Linear	Immediately	Setup	*1									
Pn585	2	Program Jogging Movement Speed	1 to 10,000	1 mm/s	50	Linear	Immediately	Setup	*1									
Pn586	2	Motor Running Cooling Ratio	0 to 100	1%/Max. speed	0	Linear	Immediately	Setup	-									
Pn587	2	Polarity Detection Execution Selection for Absolute Linear Encoder	0000 to 0001	-	0000	Linear	Immediately	Setup	*1									
		<table border="1"> <thead> <tr> <th colspan="2">Polarity Detection Selection for Absolute Linear Encoder</th> </tr> </thead> <tbody> <tr> <td>n.□□□X</td> <td>0</td> <td>Do not detect polarity.</td> </tr> <tr> <td>n.□□□X</td> <td>1</td> <td>Detect polarity.</td> </tr> </tbody> </table>									Polarity Detection Selection for Absolute Linear Encoder		n.□□□X	0	Do not detect polarity.	n.□□□X	1	Detect polarity.
		Polarity Detection Selection for Absolute Linear Encoder																
		n.□□□X	0	Do not detect polarity.														
		n.□□□X	1	Detect polarity.														
		n.□□X□	Reserved parameter (Do not change.)															
n.□X□□	Reserved parameter (Do not change.)																	
n.X□□□	Reserved parameter (Do not change.)																	
Pn600	2	Regenerative Resistor Capacity*5	Depends on model.*6	10 W	0	All	Immediately	Setup	*1									
Pn601	2	Dynamic Brake Resistor Allowable Energy Consumption	0 to 65,535	10 J	0	All	After restart	Setup	*7									
Pn603	2	Regenerative Resistance	0 to 65,535	10 mΩ	0	All	Immediately	Setup	*1									
Pn604	2	Dynamic Brake Resistance	0 to 65,535	10 mΩ	0	All	After restart	Setup	*7									
Pn621 to Pn628*4	-	Safety Module-Related Parameters	-	-	-	All	-	-	-									

Continued on next page.

Continued from previous page.

Parameter No.	Size	Name	Setting Range	Setting Unit	Default Setting	Applicable Motors	When Enabled	Classification	Reference	
Pn800	2	Communications Controls	0000 to 1FF3	–	1040	All	Immediately	Setup	–	
	n.□□□X		MECHATROLINK Communications Check Mask for Debugging							
			0	Do not mask.						
			1	Ignore MECHATROLINK communications errors (A.E60).						
			2	Ignore WDT errors (A.E50).						
			3	Ignore both MECHATROLINK communications errors (A.E60) and WDT errors (A.E50).						
	n.□□X□		Warning Check Masks							
			0	Do not mask.						
			1	Ignore data setting warnings (A.94□).						
			2	Ignore command warnings (A.95□).						
			3	Ignore both A.94□ and A.95□ warnings.						
			4	Ignore communications warnings (A.96□).						
			5	Ignore both A.94□ and A.96□ warnings.						
			6	Ignore both A.95□ and A.96□ warnings.						
			7	Ignore A.94□, A.95□, and A.96□ warnings.						
			8	Ignore data setting warnings (A.97A and A.97b).						
			9	Ignore A.94□, A.97A, and A.97b warnings.						
			A	Ignore A.95□, A.97A, and A.97b warnings.						
			B	Ignore A.94□, A.95□, A.97A, and A.97b warnings.						
			C	Ignore A.96□, A.97A, and A.97b warnings.						
			D	Ignore A.94□, A.96□, A.97A, and A.97b warnings.						
		E	Ignore A.95□, A.96□, A.97A, and A.97b warnings.							
		F	Ignore A.94□, A.95□, A.96□, A.97A, and A.97b warnings.							
n.□X□□		Reserved parameter (Do not change.)								
n.X□□□		Automatic Warning Clear Selection for Debugging^{*7}								
M3 ^{*7}		0	Retain warnings for debugging.							
		1	Automatically clear warnings (MECHATROLINK-III specification).							
Pn801	2	Application Function Selections 6 (Software Limits)	0000 to 0103	–	0003	All	Immediately	Setup	*1	
	n.□□□X		Software Limit Selection							
			0	Enable both forward and reverse software limits.						
			1	Disable forward software limit.						
			2	Disable reverse software limit.						
			3	Disable both forward and reverse software limits.						
	n.□□X□		Reserved parameter (Do not change.)							
n.□X□□		Software Limit Check for References								
		0	Do not perform software limit checks for references.							
		1	Perform software limit checks for references.							
n.X□□□		Reserved parameter (Do not change.)								
Pn803	2	Origin Range	0 to 250	1 reference unit	10	All	Immediately	Setup	*2	

Continued on next page.

5.2 SERVOPACKs with MECHATROLINK-III Communications References

5.2.2 List of Servo Parameters

Continued from previous page.

Parameter No.	Size	Name	Setting Range	Setting Unit	Default Setting	Applicable Motors	When Enabled	Classification	Reference							
Pn804	4	Forward Software Limit	-1,073,741,823 to 1,073,741,823	1 reference unit	1073741823	All	Immediately	Setup	*1							
Pn806	4	Reverse Software Limit	-1,073,741,823 to 1,073,741,823	1 reference unit	-1073741823	All	Immediately	Setup	*1							
Pn808	4	Absolute Encoder Origin Offset	-1,073,741,823 to 1,073,741,823	1 reference unit	0	All	Immediately ^{*9}	Setup	*1							
Pn80A	2	First Stage Linear Acceleration Constant	1 to 65,535	10,000 reference units/s ²	100	All	Immediately ^{*10}	Setup	*2							
Pn80B	2	Second Stage Linear Acceleration Constant	1 to 65,535	10,000 reference units/s ²	100	All	Immediately ^{*10}	Setup	*2							
Pn80C	2	Acceleration Constant Switching Speed	0 to 65,535	100 reference units/s	0	All	Immediately ^{*10}	Setup	*2							
Pn80D	2	First Stage Linear Deceleration Constant	1 to 65,535	10,000 reference units/s ²	100	All	Immediately ^{*10}	Setup	*2							
Pn80E	2	Second Stage Linear Deceleration Constant	1 to 65,535	10,000 reference units/s ²	100	All	Immediately ^{*10}	Setup	*2							
Pn80F	2	Deceleration Constant Switching Speed	0 to 65,535	100 reference units/s	0	All	Immediately ^{*10}	Setup	*2							
Pn810	2	Exponential Acceleration/Deceleration Bias	0 to 65,535	100 reference units/s	0	All	Immediately ^{*11}	Setup	*2							
Pn811	2	Exponential Acceleration/Deceleration Time Constant	0 to 5,100	0.1 ms	0	All	Immediately ^{*11}	Setup	*2							
Pn812	2	Movement Average Time	0 to 5,100	0.1 ms	0	All	Immediately ^{*11}	Setup	*2							
Pn814	4	External Positioning Final Travel Distance	-1,073,741,823 to 1,073,741,823	1 reference unit	100	All	Immediately	Setup	*2							
Pn816	2	Origin Return Mode Settings	0000 to 0001	–	0000	All	Immediately	Setup	*12							
		<table border="1" style="width:100%; border-collapse: collapse;"> <tr> <th colspan="2" style="text-align: left;">Origin Return Direction</th> </tr> <tr> <td style="width: 10%;">0</td> <td>Return in forward direction.</td> </tr> <tr> <td>1</td> <td>Return in reverse direction.</td> </tr> </table>									Origin Return Direction		0	Return in forward direction.	1	Return in reverse direction.
		Origin Return Direction														
		0	Return in forward direction.													
		1	Return in reverse direction.													
		n.□□□□ Reserved parameter (Do not change.)														
n.□X□□ Reserved parameter (Do not change.)																
n.X□□□ Reserved parameter (Do not change.)																
Pn817 ^{*14}	2	Origin Approach Speed 1	0 to 65,535	100 reference units/s	50	All	Immediately ^{*10}	Setup	*2							
Pn818 ^{*15}	2	Origin Approach Speed 2	0 to 65,535	100 reference units/s	5	All	Immediately ^{*10}	Setup	*2							
Pn819	4	Final Travel Distance for Origin Return	-1,073,741,823 to 1,073,741,823	1 reference unit	100	All	Immediately	Setup	*2							

Continued on next page.

Continued from previous page.

Parameter No.	Size	Name	Setting Range	Setting Unit	Default Setting	Applicable Motors	When Enabled	Classification	Reference	
Pn81E M2 ^{*13}	2	Input Signal Monitor Selections	0000 to 7777	–	0000	All	Immediately	Setup	*12	
			IO12 Signal Mapping							
	n.□□□X		0	Do not map.						
			1	Monitor CN1-13 input terminal.						
			2	Monitor CN1-7 input terminal.						
			3	Monitor CN1-8 input terminal.						
			4	Monitor CN1-9 input terminal.						
			5	Monitor CN1-10 input terminal.						
			6	Monitor CN1-11 input terminal.						
			7	Monitor CN1-12 input terminal.						
			IO13 Signal Mapping							
	n.□□X□		0 to 7	The mappings are the same as the IO12 signal mappings.						
			IO14 Signal Mapping							
	n.□X□□		0 to 7	The mappings are the same as the IO12 signal mappings.						
			IO15 Signal Mapping							
n.X□□□		0 to 7	The mappings are the same as the IO12 signal mappings.							
Pn81F M2 ^{*13}	2	Command Data Allocations	0000 to 1111	–	0010	All	After restart	Setup	*12	
			Option Field Allocation							
	n.□□□X		0	Disable option field allocation.						
			1	Enable option field allocation.						
			Position Control Command TFF/TLIM Allocation							
	n.□□X□		0	Disable allocation.						
			1	Enable allocation.						
	n.□X□□		Reserved parameter (Do not change.)							
	n.X□□□		Reserved parameter (Do not change.)							
	Pn820	4	Forward Latching Area	-2,147,483,648 to 2,147,483,647	1 reference unit	0	All	Immediately	Setup	*2
Pn822	4	Reverse Latching Area	-2,147,483,648 to 2,147,483,647	1 reference unit	0	All	Immediately	Setup	*2	

Continued on next page.

Continued from previous page.

Parameter No.	Size	Name	Setting Range	Setting Unit	Default Setting	Applicable Motors	When Enabled	Classification	Reference	
Pn824 M3 ^{*8}	2	Option Monitor 1 Selection	0000 to FFFF	-	0000	-	Immediately	Setup	*2	
			Setting		Monitor			Applicable Motors		
	High-Speed Monitor Region									
		0000 hex	Motor speed [1000000 hex/overspeed detection speed]						All	
		0001 hex	Speed reference [1000000 hex/overspeed detection speed]						All	
		0002 hex	Torque [1000000 hex/maximum torque]						All	
		0003 hex	Position deviation (lower 32 bits) [reference units]						All	
		0004 hex	Position deviation (upper 32 bits) [reference units]						All	
		000A hex	Encoder count (lower 32 bits) [reference units]						All	
		000B hex	Encoder count (upper 32 bits) [reference units]						All	
		000C hex	FPG count (lower 32 bits) [reference units]						All	
		000D hex	FPG count (upper 32 bits) [reference units]						All	
	Low-Speed Monitor Region									
		0010 hex	Un000: Motor speed [min ⁻¹]						All	
		0011 hex	Un001: Speed Reference [min ⁻¹]						All	
		0012 hex	Un002: Torque Reference [%]						All	
		0013 hex	Un003: Rotational Angle 1 [encoder pulses] Number of encoder pulses from origin within one encoder rotation displayed in decimal						All	
			Un003: Rotational Angle 1 [linear encoder pulses] Linear encoder pulses from the polarity origin displayed in decimal							
		0014 hex	Un004: Rotational Angle 2 [deg] Electrical angle from polarity origin						All	
			Un004: Electrical Angle 2 [deg] Electrical angle from polarity origin							
		0015 hex	Un005: Input Signal Monitor						All	
		0016 hex	Un006: Output Signal Monitor						All	
		0017 hex	Un007: Input Reference Speed [min ⁻¹]						All	
		0018 hex	Un008: Position Deviation [reference units]						All	
		0019 hex	Un009: Accumulated Load Ratio [%]						All	
		001A hex	Un00A: Regenerative Load Ratio [%]						All	
		001B hex	Un00B: Dynamic Brake Resistor Power Consumption [%]						All	
		001C hex	Un00C: Input Reference Pulse Counter [reference units]						All	
		001D hex	Un00D: Feedback Pulse Counter [encoder pulses]						All	
		001E hex	Un00E: Fully-closed Loop Feedback Pulse Counter [external encoder resolution]						Rotary	
		0023 hex	Initial multiturn data [Rev]						Rotary	
		0024 hex	Initial incremental data [pulses]						Rotary	
		0025 hex	Initial absolute position data (lower 32 bits) [pulses]						Linear	
		0026 hex	Initial absolute position data (upper 32 bits) [pulses]						Linear	
		0040 hex	Un025: SERVOPACK Installation Environment Monitor						All	
		0041 hex	Un026: Servomotor Installation Environment Monitor						All	
		0042 hex	Un027: Built-in Fan Remaining Life Ratio						All	
		0043 hex	Un028: Capacitor Remaining Life Ratio						All	
		0044 hex	Un029: Surge Prevention Circuit Remaining Life Ratio						All	
		0045 hex	Un02A: Dynamic Brake Circuit Remaining Life Ratio						All	
		0046 hex	Un032: Instantaneous Power						All	
		0047 hex	Un033: Power Consumption						All	
		0048 hex	Un034: Cumulative Power Consumption						All	

Continued on next page.

Continued from previous page.

Parameter No.	Size	Name	Setting Range	Setting Unit	Default Setting	Applicable Motors	When Enabled	Classification	Reference	
Pn824 M3 ^{*8}	Setting		Monitor				Applicable Motors			
	Communications Module Only									
	0080 hex	Previous value of latched feedback position (LPOS1) [encoder pulses]					All			
	0081 hex	Previous value of latched feedback position (LPOS2) [encoder pulses]					All			
	0084 hex	Continuous Latch Status (EX STATUS)					All			
	All Areas									
	Other values	Reserved settings (Do not use.)					All			
Pn825	2	Option Monitor 2 Selection	0000 to FFFF	–	0000	All	Immediately	Setup	*2	
		0000 hex to 0084 hex	The settings are the same as those for the Option Monitor 1 Selection.							
Pn827	2	Linear Deceleration Constant 1 for Stopping	1 to 65,535	10,000 reference units/s ²	100	All	Immediately ^{*10}	Setup	*2	
Pn829	2	SVOFF Waiting Time (for SVOFF at Deceleration to Stop)	0 to 65,535	10 ms	0	All	Immediately ^{*10}	Setup	*2	
Pn82A M2 ^{*13}	2	Option Field Allocations 1	0000 to 1E1E	–	1813	All	After restart	Setup	*12	
			ACCFIL Allocation (Option)							
			0	Allocate bits 0 and 1 to ACCFIL.						
			1	Allocate bits 1 and 2 to ACCFIL.						
			2	Allocate bits 2 and 3 to ACCFIL.						
			3	Allocate bits 3 and 4 to ACCFIL.						
			4	Allocate bits 4 and 5 to ACCFIL.						
			5	Allocate bits 5 and 6 to ACCFIL.						
			6	Allocate bits 6 and 7 to ACCFIL.						
			7	Allocate bits 7 and 8 to ACCFIL.						
			8	Allocate bits 8 and 9 to ACCFIL.						
			9	Allocate bits 9 and 10 to ACCFIL.						
			A	Allocate bits 10 and 11 to ACCFIL.						
			B	Allocate bits 11 and 12 to ACCFIL.						
			C	Allocate bits 12 and 13 to ACCFIL.						
		D	Allocate bits 13 and 14 to ACCFIL.							
		E	Allocate bits 14 and 15 to ACCFIL.							
		ACCFIL Allocation Enable/Disable Selection								
		0	Disable ACCFIL allocation.							
		1	Enable ACCFIL allocation.							
		G_SEL Allocation (Option)								
		0 to E	The settings are the same as for the ACCFIL allocations.							
		G_SEL Allocation Enable/Disable Selection								
		0	Disable G_SEL allocation.							
		1	Enable G_SEL allocation.							

Continued on next page.

Continued from previous page.

Parameter No.	Size	Name	Setting Range	Setting Unit	Default Setting	Applicable Motors	When Enabled	Classification	Reference																											
Pn82B M2 ^{*13}	2	Option Field Allocations	0000 to 1F1F	-	1D1C	All	After restart	Setup	*12																											
	<table border="1"> <thead> <tr> <th colspan="2">V_PPI Allocation (Option)</th> </tr> </thead> <tbody> <tr><td>0</td><td>Allocate bit 0 to V_PPI.</td></tr> <tr><td>1</td><td>Allocate bit 1 to V_PPI.</td></tr> <tr><td>2</td><td>Allocate bit 2 to V_PPI.</td></tr> <tr><td>3</td><td>Allocate bit 3 to V_PPI.</td></tr> <tr><td>4</td><td>Allocate bit 4 to V_PPI.</td></tr> <tr><td>5</td><td>Allocate bit 5 to V_PPI.</td></tr> <tr><td>6</td><td>Allocate bit 6 to V_PPI.</td></tr> <tr><td>7</td><td>Allocate bit 7 to V_PPI.</td></tr> <tr><td>8</td><td>Allocate bit 8 to V_PPI.</td></tr> <tr><td>9</td><td>Allocate bit 9 to V_PPI.</td></tr> <tr><td>A</td><td>Allocate bit 10 to V_PPI.</td></tr> <tr><td>B</td><td>Allocate bit 11 to V_PPI.</td></tr> <tr><td>C</td><td>Allocate bit 12 to V_PPI.</td></tr> <tr><td>D</td><td>Allocate bit 13 to V_PPI.</td></tr> <tr><td>E</td><td>Allocate bit 14 to V_PPI.</td></tr> <tr><td>F</td><td>Allocate bit 15 to V_PPI.</td></tr> </tbody> </table>		V_PPI Allocation (Option)		0	Allocate bit 0 to V_PPI.	1	Allocate bit 1 to V_PPI.	2	Allocate bit 2 to V_PPI.	3	Allocate bit 3 to V_PPI.	4	Allocate bit 4 to V_PPI.	5	Allocate bit 5 to V_PPI.	6	Allocate bit 6 to V_PPI.	7	Allocate bit 7 to V_PPI.	8	Allocate bit 8 to V_PPI.	9	Allocate bit 9 to V_PPI.	A	Allocate bit 10 to V_PPI.	B	Allocate bit 11 to V_PPI.	C	Allocate bit 12 to V_PPI.	D	Allocate bit 13 to V_PPI.	E	Allocate bit 14 to V_PPI.	F	Allocate bit 15 to V_PPI.
	V_PPI Allocation (Option)																																			
	0	Allocate bit 0 to V_PPI.																																		
	1	Allocate bit 1 to V_PPI.																																		
	2	Allocate bit 2 to V_PPI.																																		
	3	Allocate bit 3 to V_PPI.																																		
	4	Allocate bit 4 to V_PPI.																																		
	5	Allocate bit 5 to V_PPI.																																		
	6	Allocate bit 6 to V_PPI.																																		
	7	Allocate bit 7 to V_PPI.																																		
	8	Allocate bit 8 to V_PPI.																																		
	9	Allocate bit 9 to V_PPI.																																		
	A	Allocate bit 10 to V_PPI.																																		
	B	Allocate bit 11 to V_PPI.																																		
	C	Allocate bit 12 to V_PPI.																																		
	D	Allocate bit 13 to V_PPI.																																		
	E	Allocate bit 14 to V_PPI.																																		
	F	Allocate bit 15 to V_PPI.																																		
	<table border="1"> <thead> <tr> <th colspan="2">V_PPI Allocation Enable/Disable Selection</th> </tr> </thead> <tbody> <tr><td>0</td><td>Disable V_PPI allocation.</td></tr> <tr><td>1</td><td>Enable V_PPI allocation.</td></tr> </tbody> </table>		V_PPI Allocation Enable/Disable Selection		0	Disable V_PPI allocation.	1	Enable V_PPI allocation.																												
V_PPI Allocation Enable/Disable Selection																																				
0	Disable V_PPI allocation.																																			
1	Enable V_PPI allocation.																																			
<table border="1"> <thead> <tr> <th colspan="2">P_PI_CLR Allocation (Option)</th> </tr> </thead> <tbody> <tr><td>0 to F</td><td>The settings are the same as for the V_PPI allocations.</td></tr> </tbody> </table>		P_PI_CLR Allocation (Option)		0 to F	The settings are the same as for the V_PPI allocations.																															
P_PI_CLR Allocation (Option)																																				
0 to F	The settings are the same as for the V_PPI allocations.																																			
<table border="1"> <thead> <tr> <th colspan="2">P_PI_CLR Allocation Enable/Disable Selection</th> </tr> </thead> <tbody> <tr><td>0</td><td>Disable P_PI_CLR allocation.</td></tr> <tr><td>1</td><td>Enable P_PI_CLR allocation.</td></tr> </tbody> </table>		P_PI_CLR Allocation Enable/Disable Selection		0	Disable P_PI_CLR allocation.	1	Enable P_PI_CLR allocation.																													
P_PI_CLR Allocation Enable/Disable Selection																																				
0	Disable P_PI_CLR allocation.																																			
1	Enable P_PI_CLR allocation.																																			
Pn82C M2 ^{*13}	2	Option Field Allocations	0000 to 1F1F	-	1F1E	All	After restart	Setup	*12																											
	<table border="1"> <thead> <tr> <th colspan="2">P_CL Allocation (Option)</th> </tr> </thead> <tbody> <tr><td>0 to F</td><td>The settings are the same as for the V_PPI allocations.</td></tr> </tbody> </table>		P_CL Allocation (Option)		0 to F	The settings are the same as for the V_PPI allocations.																														
	P_CL Allocation (Option)																																			
	0 to F	The settings are the same as for the V_PPI allocations.																																		
	<table border="1"> <thead> <tr> <th colspan="2">P_CL Allocation Enable/Disable Selection</th> </tr> </thead> <tbody> <tr><td>0</td><td>Disable P_CL allocation.</td></tr> <tr><td>1</td><td>Enable P_CL allocation.</td></tr> </tbody> </table>		P_CL Allocation Enable/Disable Selection		0	Disable P_CL allocation.	1	Enable P_CL allocation.																												
	P_CL Allocation Enable/Disable Selection																																			
	0	Disable P_CL allocation.																																		
	1	Enable P_CL allocation.																																		
	<table border="1"> <thead> <tr> <th colspan="2">N_CL Allocation (Option)</th> </tr> </thead> <tbody> <tr><td>0 to F</td><td>The settings are the same as for the V_PPI allocations.</td></tr> </tbody> </table>		N_CL Allocation (Option)		0 to F	The settings are the same as for the V_PPI allocations.																														
	N_CL Allocation (Option)																																			
0 to F	The settings are the same as for the V_PPI allocations.																																			
<table border="1"> <thead> <tr> <th colspan="2">N_CL Allocation Enable/Disable Selection</th> </tr> </thead> <tbody> <tr><td>0</td><td>Disable N_CL allocation.</td></tr> <tr><td>1</td><td>Enable N_CL allocation.</td></tr> </tbody> </table>		N_CL Allocation Enable/Disable Selection		0	Disable N_CL allocation.	1	Enable N_CL allocation.																													
N_CL Allocation Enable/Disable Selection																																				
0	Disable N_CL allocation.																																			
1	Enable N_CL allocation.																																			

Continued on next page.

Continued from previous page.

Parameter No.	Size	Name	Setting Range	Setting Unit	Default Setting	Applicable Motors	When Enabled	Classification	Reference																												
Pn82D M2 ^{*13}	2	Option Field Allocations	0000 to 1F1C	-	0000	All	After restart	Setup	*12																												
		<table border="1"> <thead> <tr> <th colspan="2">BANK_SEL1 Allocation (Option)</th> </tr> </thead> <tbody> <tr><td>0</td><td>Allocate bits 0 to 3 to BANK_SEL1.</td></tr> <tr><td>1</td><td>Allocate bits 1 to 4 to BANK_SEL1.</td></tr> <tr><td>2</td><td>Allocate bits 2 to 5 to BANK_SEL1.</td></tr> <tr><td>3</td><td>Allocate bits 3 to 6 to BANK_SEL1.</td></tr> <tr><td>4</td><td>Allocate bits 4 to 7 to BANK_SEL1.</td></tr> <tr><td>5</td><td>Allocate bits 5 to 8 to BANK_SEL1.</td></tr> <tr><td>6</td><td>Allocate bits 6 to 9 to BANK_SEL1.</td></tr> <tr><td>7</td><td>Allocate bits 7 to 10 to BANK_SEL1.</td></tr> <tr><td>8</td><td>Allocate bits 8 to 11 to BANK_SEL1.</td></tr> <tr><td>9</td><td>Allocate bits 9 to 12 to BANK_SEL1.</td></tr> <tr><td>A</td><td>Allocate bits 10 to 13 to BANK_SEL1.</td></tr> <tr><td>B</td><td>Allocate bits 11 to 14 to BANK_SEL1.</td></tr> <tr><td>C</td><td>Allocate bits 12 to 15 to BANK_SEL1.</td></tr> </tbody> </table>								BANK_SEL1 Allocation (Option)		0	Allocate bits 0 to 3 to BANK_SEL1.	1	Allocate bits 1 to 4 to BANK_SEL1.	2	Allocate bits 2 to 5 to BANK_SEL1.	3	Allocate bits 3 to 6 to BANK_SEL1.	4	Allocate bits 4 to 7 to BANK_SEL1.	5	Allocate bits 5 to 8 to BANK_SEL1.	6	Allocate bits 6 to 9 to BANK_SEL1.	7	Allocate bits 7 to 10 to BANK_SEL1.	8	Allocate bits 8 to 11 to BANK_SEL1.	9	Allocate bits 9 to 12 to BANK_SEL1.	A	Allocate bits 10 to 13 to BANK_SEL1.	B	Allocate bits 11 to 14 to BANK_SEL1.	C	Allocate bits 12 to 15 to BANK_SEL1.
	BANK_SEL1 Allocation (Option)																																				
	0	Allocate bits 0 to 3 to BANK_SEL1.																																			
	1	Allocate bits 1 to 4 to BANK_SEL1.																																			
	2	Allocate bits 2 to 5 to BANK_SEL1.																																			
	3	Allocate bits 3 to 6 to BANK_SEL1.																																			
	4	Allocate bits 4 to 7 to BANK_SEL1.																																			
	5	Allocate bits 5 to 8 to BANK_SEL1.																																			
	6	Allocate bits 6 to 9 to BANK_SEL1.																																			
	7	Allocate bits 7 to 10 to BANK_SEL1.																																			
	8	Allocate bits 8 to 11 to BANK_SEL1.																																			
	9	Allocate bits 9 to 12 to BANK_SEL1.																																			
	A	Allocate bits 10 to 13 to BANK_SEL1.																																			
	B	Allocate bits 11 to 14 to BANK_SEL1.																																			
	C	Allocate bits 12 to 15 to BANK_SEL1.																																			
			<table border="1"> <thead> <tr> <th colspan="2">BANK_SEL1 Allocation Enable/Disable Selection</th> </tr> </thead> <tbody> <tr><td>0</td><td>Disable BANK_SEL1 allocation.</td></tr> <tr><td>1</td><td>Enable BANK_SEL1 allocation.</td></tr> </tbody> </table>								BANK_SEL1 Allocation Enable/Disable Selection		0	Disable BANK_SEL1 allocation.	1	Enable BANK_SEL1 allocation.																					
	BANK_SEL1 Allocation Enable/Disable Selection																																				
	0	Disable BANK_SEL1 allocation.																																			
	1	Enable BANK_SEL1 allocation.																																			
		<table border="1"> <thead> <tr> <th colspan="2">LT_DISABLE Allocation (Option)</th> </tr> </thead> <tbody> <tr><td>0 to F</td><td>The settings are the same as for the V_PPI allocations.</td></tr> </tbody> </table>								LT_DISABLE Allocation (Option)		0 to F	The settings are the same as for the V_PPI allocations.																								
LT_DISABLE Allocation (Option)																																					
0 to F	The settings are the same as for the V_PPI allocations.																																				
		<table border="1"> <thead> <tr> <th colspan="2">LT_DISABLE Allocation Enable/Disable Selection</th> </tr> </thead> <tbody> <tr><td>0</td><td>Disable LT_DISABLE allocation.</td></tr> <tr><td>1</td><td>Enable LT_DISABLE allocation.</td></tr> </tbody> </table>								LT_DISABLE Allocation Enable/Disable Selection		0	Disable LT_DISABLE allocation.	1	Enable LT_DISABLE allocation.																						
LT_DISABLE Allocation Enable/Disable Selection																																					
0	Disable LT_DISABLE allocation.																																				
1	Enable LT_DISABLE allocation.																																				

Continued on next page.

Continued from previous page.

Parameter No.	Size	Name	Setting Range	Setting Unit	Default Setting	Applicable Motors	When Enabled	Classification	Reference	
Pn82E M2 *13	2	Option Field Allocations 5	0000 to 1D1F	-	0000	All	After restart	Setup	*12	
	n.□□□X		Reserved parameter (Do not change.)							
	n.□□X□		Reserved parameter (Do not change.)							
	n.□X□□		OUT_SIGNAL Allocation (Option)							
			0	Allocate bits 0 to 2 to OUT_SIGNAL.						
			1	Allocate bits 1 to 3 to OUT_SIGNAL.						
			2	Allocate bits 2 to 4 to OUT_SIGNAL.						
			3	Allocate bits 3 to 5 to OUT_SIGNAL.						
			4	Allocate bits 4 to 6 to OUT_SIGNAL.						
			5	Allocate bits 5 to 7 to OUT_SIGNAL.						
			6	Allocate bits 6 to 8 to OUT_SIGNAL.						
			7	Allocate bits 7 to 9 to OUT_SIGNAL.						
			8	Allocate bits 8 to 10 to OUT_SIGNAL.						
	9	Allocate bits 9 to 11 to OUT_SIGNAL.								
	A	Allocate bits 10 to 12 to OUT_SIGNAL.								
B	Allocate bits 11 to 13 to OUT_SIGNAL.									
C	Allocate bits 12 to 14 to OUT_SIGNAL.									
D	Allocate bits 13 to 15 to OUT_SIGNAL.									
n.X□□□		OUT_SIGNAL Allocation Enable/Disable Selection								
		0	Disable OUT_SIGNAL allocation.							
		1	Enable OUT_SIGNAL allocation.							
Pn833	2	Motion Settings	0000 to 0001	-	0000	All	After restart	Setup	*2	
	n.□□□X		Linear Acceleration/Deceleration Constant Selection							
			0	Use Pn80A to Pn80F and Pn827. (The settings of Pn834 to Pn840 are ignored.)						
			1	Use Pn834 to Pn840. (The settings of Pn80A to Pn80F and Pn827 are ignored.)						
	n.□□X□		Reserved parameter (Do not change.)							
	n.□X□□		Reserved parameter (Do not change.)							
n.X□□□		Reserved parameter (Do not change.)								
Pn834	4	First Stage Linear Acceleration Constant 2	1 to 20,971,520	10,000 reference units/s ²	100	All	Immediately *10	Setup	*2	
Pn836	4	Second Stage Linear Acceleration Constant 2	1 to 20,971,520	10,000 reference units/s ²	100	All	Immediately *10	Setup	*2	
Pn838	4	Acceleration Constant Switching Speed 2	0 to 2,097,152,000	1 reference unit/s	0	All	Immediately *10	Setup	*2	
Pn83A	4	First Stage Linear Deceleration Constant 2	1 to 20,971,520	10,000 reference units/s ²	100	All	Immediately *10	Setup	*2	

Continued on next page.

Continued from previous page.

Parameter No.	Size	Name	Setting Range	Setting Unit	Default Setting	Applicable Motors	When Enabled	Classification	Reference	
Pn83C	4	Second Stage Linear Deceleration Constant 2	1 to 20,971,520	10,000 reference units/s ²	100	All	Immediately *10	Setup	*2	
Pn83E	4	Deceleration Constant Switching Speed 2	0 to 2,097,152,000	1 reference unit/s	0	All	Immediately *10	Setup	*2	
Pn840	4	Linear Deceleration Constant 2 for Stopping	1 to 20,971,520	10,000 reference units/s ²	100	All	Immediately *10	Setup	*2	
Pn842 *14	4	Second Origin Approach Speed 1	0 to 20,971,520	100 reference units/s	0	All	Immediately *10	Setup	*2	
Pn844 *15	4	Second Origin Approach Speed 2	0 to 20,971,520	100 reference units/s	0	All	Immediately *10	Setup	*2	
Pn846	2	POSING Command Scurve Acceleration/Deceleration Rate	0 to 50	1%	0	All	Immediately *10	Setup	–	
Pn850	2	Number of Latch Sequences	0 to 8	–	0	All	Immediately	Setup	*2	
Pn851	2	Continuous Latch Sequence Count	0 to 255	–	0	All	Immediately	Setup	*2	
Pn852	2	Latch Sequence 1 to 4 Settings	0000 to 3333	–	0000	All	Immediately	Setup	*2	
			Latch Sequence 1 Signal Selection							
	n.□□□X		0	Phase C						
			1	EXT1 signal						
			2	EXT2 signal						
			3	EXT3 signal						
			Latch Sequence 2 Signal Selection							
	n.□□X□		0 to 3	The settings are the same as those for the Latch Sequence 1 Signal Selection.						
			Latch Sequence 3 Signal Selection							
	n.□X□□		0 to 3	The settings are the same as those for the Latch Sequence 1 Signal Selection.						
		Latch Sequence 4 Signal Selection								
n.X□□□		0 to 3	The settings are the same as those for the Latch Sequence 1 Signal Selection.							

Continued on next page.

Continued from previous page.

Parameter No.	Size	Name	Setting Range	Setting Unit	Default Setting	Applicable Motors	When Enabled	Classification	Reference
Pn861 M3 *8	2	SVCMD_IO Input Signal Monitor Allocations 2	0000 to 1717	-	0000	All	Immediately	Setup	*2
	n.□□□X	Input Signal Monitor Allocation for CN1-8 (SVCMD_IO)							
		0 to 7	The settings are the same as the CN1-13 allocations.						
	n.□□X□	CN1-8 Input Signal Monitor Enable/Disable Selection							
		0	Disable allocation for CN1-8 input signal monitor.						
		1	Enable allocation for CN1-8 input signal monitor.						
	n.□X□□	Input Signal Monitor Allocation for CN1-9 (SVCMD_IO)							
		0 to 7	The settings are the same as the CN1-13 allocations.						
	n.X□□□	CN1-9 Input Signal Monitor Enable/Disable Selection							
		0	Disable allocation for CN1-9 input signal monitor.						
		1	Enable allocation for CN1-9 input signal monitor.						
	Pn862 M3 *6	2	SVCMD_IO Input Signal Monitor Allocations 3	0000 to 1717	-	0000	All	Immediately	Setup
n.□□□X		Input Signal Monitor Allocation for CN1-10 (SVCMD_IO)							
		0 to 7	The settings are the same as the CN1-13 allocations.						
n.□□X□		CN1-10 Input Signal Monitor Enable/Disable Selection							
		0	Disable allocation for CN1-10 input signal monitor.						
		1	Enable allocation for CN1-10 input signal monitor.						
n.□X□□		Input Signal Monitor Allocation for CN1-11 (SVCMD_IO)							
		0 to 7	The settings are the same as the CN1-13 allocations.						
n.X□□□		CN1-11 Input Signal Monitor Enable/Disable Selection							
		0	Disable allocation for CN1-11 input signal monitor.						
		1	Enable allocation for CN1-11 input signal monitor.						
Pn863 M3 *8		2	SVCMD_IO Input Signal Monitor Allocations 4	0000 to 1717	-	0000	All	Immediately	Setup
	n.□□□X	Input Signal Monitor Allocation for CN1-12 (SVCMD_IO)							
		0 to 7	The settings are the same as the CN1-13 allocations.						
	n.□□X□	CN1-12 Input Signal Monitor Enable/Disable Selection							
		0	Disable allocation for CN1-12 input signal monitor.						
		1	Enable allocation for CN1-12 input signal monitor.						
	n.□X□□	Reserved parameter (Do not change.)							
	n.X□□□	Reserved parameter (Do not change.)							

Continued on next page.





Continued from previous page.

Parameter No.	Size	Name	Setting Range	Setting Unit	Default Setting	Applicable Motors	When Enabled	Classification	Reference	
Pn868 M3 *8	2	SVCMD_IO Output Signal Monitor Allocations 1	0000 to 1717	–	0000	All	Immediately	Setup	*2	
			Output Signal Monitor Allocation for CN1-1 and CN1-2 (SVCMD_IO)							
	n.□□□X		0	Allocate bit 24 (IO_STS1) to CN1-1/CN1-2 output signal monitor.						
			1	Allocate bit 25 (IO_STS2) to CN1-1/CN1-2 output signal monitor.						
			2	Allocate bit 26 (IO_STS3) to CN1-1/CN1-2 output signal monitor.						
			3	Allocate bit 27 (IO_STS4) to CN1-1/CN1-2 output signal monitor.						
			4	Allocate bit 28 (IO_STS5) to CN1-1/CN1-2 output signal monitor.						
			5	Allocate bit 29 (IO_STS6) to CN1-1/CN1-2 output signal monitor.						
			6	Allocate bit 30 (IO_STS7) to CN1-1/CN1-2 output signal monitor.						
			7	Allocate bit 31 (IO_STS8) to CN1-1/CN1-2 output signal monitor.						
			CN1-1/CN1-2 Output Signal Monitor Enable/Disable Selection							
	n.□□X□		0	Disable allocation for CN1-1/CN1-2 output signal monitor.						
			1	Enable allocation for CN1-1/CN1-2 output signal monitor.						
			Output Signal Monitor Allocation for CN1-23 and CN1-24 (SVCMD_IO)							
	n.□X□□		0 to 7	The settings are the same as the CN1-1/CN1-2 allocations.						
			CN1-23/CN1-24 Output Signal Monitor Enable/Disable Selection							
n.X□□□		0	Disable allocation for CN1-23/CN1-24 output signal monitor.							
		1	Enable allocation for CN1-23/CN1-24 output signal monitor.							
Pn869 M3 *8	2	SVCMD_IO Output Signal Monitor Allocations 2	0000 to 1717	–	0000	All	Immediately	Setup	*2	
	n.□□□X		0 to 7	The settings are the same as the CN1-1/CN1-2 allocations.						
			CN1-25/CN1-26 Output Signal Monitor Enable/Disable Selection							
	n.□□X□		0	Disable allocation for CN1-25/CN1-26 output signal monitor.						
			1	Enable allocation for CN1-25/CN1-26 output signal monitor.						
	n.□X□□		Reserved parameter (Do not change.)							
n.X□□□		Reserved parameter (Do not change.)								
Pn880	2	Station Address Monitor (for maintenance, read only)	03 to EF	–	0	All	Immediately	Setup	–	
Pn881	2	Set Transmission Byte Count Monitor [bytes] (for maintenance, read only)	17, 32, 48	–	0	All	Immediately	Setup	–	
Pn882	2	Transmission Cycle Setting Monitor [$\times 0.25 \mu\text{s}$] (for maintenance, read only)	0 to FFFF	–	0	All	Immediately	Setup	–	
Pn883	2	Communications Cycle Setting Monitor [transmission cycles] (for maintenance, read only)	0 to 32	–	0	All	Immediately	Setup	–	

Continued on next page.

Continued from previous page.

Parameter No.	Size	Name	Setting Range	Setting Unit	Default Setting	Applicable Motors	When Enabled	Classification	Reference	
Pn884 M3 *8	2	Communications Controls 2	0000 to 0001	-	0000	All	Immediately	Setup	*2	
	n.□□□X		MECHATROLINK Communications Error Holding Brake Signal Setting							
			0	Maintain the status set by the BRK_ON or BRK_OFF command when a MECHATROLINK communications error occurs.						
			1	Apply the holding brake when a MECHATROLINK communications error occurs.						
	n.□□X□		Reserved parameter (Do not change.)							
	n.□X□□		Reserved parameter (Do not change.)							
n.X□□□		Reserved parameter (Do not change.)								
Pn88A	2	MECHATROLINK Receive Error Counter Monitor (for maintenance, read only)	0 to 65,535	-	0	All	Immediately	Setup	-	
Pn890 to Pn8A6	4	Command Data Monitor during Alarm/Warning (for maintenance, read only)	0 to FFFFFFFF	-	0	All	Immediately	Setup	*2	
Pn8A8 to Pn8BE	4	Response Data Monitor during Alarm/Warning (for maintenance, read only)	0 to FFFFFFFF	-	0	All	Immediately	Setup	*2	
Pn900	2	Number of Parameter Banks	0 to 16	-	0	All	After restart	Setup	*2	
Pn901	2	Number of Parameter Bank Members	0 to 15	-	0	All	After restart	Setup	*2	
Pn902 to Pn910	2	Parameter Bank Member Definition	0000 to 08FF	-	0	All	After restart	Setup	*2	
Pn920 to Pn95F	2	Parameter Bank Data (Not saved in nonvolatile memory.)	0000 to FFFF	-	0	All	Immediately	Setup	*2	

- *1. Refer to the following manual for details.
 Σ -7-Series Σ -7S SERVOPACK with MECHATROLINK-III Communications References Product Manual (Manual No.: SIEP S800001 28)
- *2. Refer to the following manual for details.
 Σ -7-Series MECHATROLINK-III Communications Standard Servo Profile Command Manual (Manual No.: SIEP S800001 31)
- *3. Set a percentage of the motor rated torque.
- *4. These parameters are for SERVOPACKs with a Safety Module. Refer to the following manual for details.
 Σ -V-Series/ Σ -V-Series for Large-Capacity Models/ Σ -7-Series User's Manual Safety Module (Manual No.: SIEP C720829 06)
- *5. Normally set this parameter to 0. If you use an External Regenerative Resistor, set the capacity (W) of the External Regenerative Resistor.
- *6. The upper limit is the maximum output capacity (W) of the SERVOPACK.
- *7. These parameters are for SERVOPACKs with the dynamic brake option. Refer to the following manual for details.
 Σ -7-Series Σ -7S/ Σ -7W SERVOPACK with Hardware Option Specifications Dynamic Brake Product Manual (Manual No.: SIEP S800001 73)
- *8. This parameter is valid only when the MECHATROLINK-III standard servo profile is used.
- *9. The parameter setting is enabled after SENS_ON command execution is completed.
- *10. Change the setting when the reference is stopped (i.e., while DEN is set to 1). If you change the setting during operation, the reference output will be affected.
- *11. The settings are updated only if the reference is stopped (i.e., only if DEN is set to 1).
- *12. Refer to the following manual for details.
 Σ -7-Series MECHATROLINK-II Communications Command Manual (Manual No.: SIEP S800001 30)
- *13. This parameter is valid only when the MECHATROLINK-II-compatible profile is used.
- *14. The setting of Pn842 is valid while Pn817 is set to 0.
- *15. The setting of Pn844 is valid while Pn818 is set to 0.

5.2.3 List of MECHATROLINK-III Common Parameters

The following table lists the common MECHATROLINK-III parameters. These common parameters are used to make settings from the host controller via MECHATROLINK communications. Do not change the settings with the Digital Operator or any other device.

Parameter No.	Size	Name	Setting Range	Setting Unit [Resolution]	Default Setting	Applicable Motors	When Enabled	Classification	
01 PnA02	4	Encoder Type Selection (read only)	0 to 1	-	-	All	-	Device information	
		0000 hex							Absolute encoder
		0001 hex							Incremental encoder
02 PnA04	4	Motor Type Selection (read only)	0 to 1	-	-	All	-		
		0000 hex							Rotary Servomotor
		0001 hex							Linear Servomotor
03 PnA06	4	Semi-closed/Fully-closed Selection (read only)	0 to 1	-	-	All	-		
		0000 hex							Semi-closed
		0001 hex							Fully-closed
04 PnA08	4	Rated Motor Speed (read only)	0 to FFFFFFFF	1 min ⁻¹	-	All	-		Device information
05 PnA0A	4	Maximum Output Speed (read only)	0 to FFFFFFFF	1 min ⁻¹	-	All	-		
06 PnA0C	4	Speed Multiplier (read only)	-1,073,741,823 to 1,073,741,823	-	-	All	-		
07 PnA0E	4	Rated Torque (read only)	0 to FFFFFFFF	1 N·m	-	All	-		
08 PnA10	4	Maximum Output Torque (read only)	0 to FFFFFFFF	1 N·m	-	All	-		
09 PnA12	4	Torque Multiplier (read only)	-1,073,741,823 to 1,073,741,823	-	-	All	-		
0A PnA14	4	Resolution (read only)	0 to FFFFFFFF	1 pulse/rev	-	Rotary	-		
0B PnA16	4	Scale Pitch	0 to 65,536,000	1 nm [0.01 μm]	0	Linear	After restart*1		
0C PnA18	4	Pulses per Scale Pitch (read only)	0 to FFFFFFFF	1 pulse/pitch	-	Linear	-		

Continued on next page.

Continued from previous page.

Parameter No.	Size	Name	Setting Range	Setting Unit [Resolution]	Default Setting	Applicable Motors	When Enabled	Classification	
21 PnA42	4	Electronic Gear Ratio (Numerator)	1 to 1,073,741,824	–	16	All	After restart	Machine specifications	
22 PnA44	4	Electronic Gear Ratio (Denominator)	1 to 1,073,741,824	–	1	All	After restart		
23 PnA46	4	Absolute Encoder Origin Offset	-1,073,741,823 to 1,073,741,823	1 reference unit	0	All	Immediately*1		
24 PnA48	4	Multiturn Limit Setting	0 to 65,535	1 Rev	65535	Rotary	After restart		
25 PnA4A	4	Limit Setting	0 to 33 hex	–	0000 hex	All	After restart		
		Bit 0	P-OT (0: Enabled, 1: Disabled)						
		Bit 1	N-OT (0: Enabled, 1: Disabled)						
		Bit 2	Reserved.						
		Bit 3	Reserved.						
		Bit 4	P-SOT (0: Disabled, 1: Enabled)						
		Bit 5	N-SOT (0: Disabled, 1: Enabled)						
26 PnA4C	4	Forward Software Limit	-1,073,741,823 to 1,073,741,823	1 reference unit	1073741823	All	Immediately		
27 PnA4E	4	Reserved parameter (Do not change.)	–	–	0	All	Immediately		
28 PnA50	4	Reverse Software Limit	-1,073,741,823 to 1,073,741,823	1 reference unit	-1073741823	All	Immediately		
29 PnA52	4	Reserved parameter (Do not change.)	–	–	0	All	Immediately		
41 PnA82	4	Speed Unit Selection*2	0 to 4	–	0	All	After restart	Unit settings	
		0000 hex	Reference units/s						
		0001 hex	Reference units/min						
		0002 hex	Percentage (%) of rated speed*3						
		0003 hex	min ⁻¹ *3						
		0004 hex	Maximum motor speed/40000000 hex*4						
42 PnA84	4	Speed Base Unit Selection*3, *4 (Set the value of n from the following formula: Speed unit selection (41 PnA82) × 10 ⁿ)	-3 to 3	–	0	All	After restart		
43 PnA86	4	Position Unit Selection	0	–	0	All	After restart		
		0000 hex	Reference units						

Continued on next page.

5.2.3 List of MECHATROLINK-III Common Parameters

Continued from previous page.

Parameter No.	Size	Name	Setting Range	Setting Unit [Resolution]	Default Setting	Applicable Motors	When Enabled	Classification																																							
44 PnA88	4	Position Base Unit Selection (Set the value of n from the following formula: Position unit selection (43 PnA86) × 10 ⁿ)	0	-	0	All	After restart	Unit settings																																							
45 PnA8A	4	Acceleration Unit Selection	0	-	0	All	After restart																																								
		0000 hex Reference units/s ²																																													
46 PnA8C	4	Acceleration Base Unit Selection (Set the value of n from the following formula: Acceleration unit selection (45 PnA8A) × 10 ⁿ)	4 to 6	-	4	All	After restart																																								
47 PnA8E	4	Torque Unit Selection	1 to 2	-	1	All	After restart																																								
		0001 hex Percentage (%) of rated torque																																													
		0002 hex Maximum torque/40000000 hex ⁵																																													
48 PnA90	4	Torque Base Unit Selection ^{*5} (Set the value of n from the following formula: Torque unit selection (47 PnA8E) × 10 ⁿ)	-5 to 0	-	0	All	After restart																																								
49 PnA92	4	Supported Unit Systems (read only)	-	-	0601011F hex	All	-																																								
		<table border="1" style="width: 100%; border-collapse: collapse;"> <thead> <tr> <th colspan="2" style="background-color: #cccccc;">Speed Units</th> </tr> </thead> <tbody> <tr> <td>Bit 0</td> <td>Reference units/s (1: Enabled)</td> </tr> <tr> <td>Bit 1</td> <td>Reference units/min (1: Enabled)</td> </tr> <tr> <td>Bit 2</td> <td>Percentage (%) of rated speed (1: Enabled)</td> </tr> <tr> <td>Bit 3</td> <td>min⁻¹ (rpm) (1: Enabled)</td> </tr> <tr> <td>Bit 4</td> <td>Maximum motor speed/4000000 hex (1: Enabled)</td> </tr> <tr> <td>Bits 5 to 7</td> <td>Reserved (0: Disabled).</td> </tr> <tr> <th colspan="2" style="background-color: #cccccc;">Position Units</th> </tr> <tr> <td>Bit 8</td> <td>Reference units (1: Enabled)</td> </tr> <tr> <td>Bits 9 to 15</td> <td>Reserved (0: Disabled).</td> </tr> <tr> <th colspan="2" style="background-color: #cccccc;">Acceleration Units</th> </tr> <tr> <td>Bit 16</td> <td>Reference units/s² (1: Enabled)</td> </tr> <tr> <td>Bit 17</td> <td>ms (acceleration time required to reach rated speed) (0: Disabled)</td> </tr> <tr> <td>Bits 18 to 23</td> <td>Reserved (0: Disabled).</td> </tr> <tr> <th colspan="2" style="background-color: #cccccc;">Torque Units</th> </tr> <tr> <td>Bit 24</td> <td>N·m (0: Disabled)</td> </tr> <tr> <td>Bit 25</td> <td>Percentage (%) of rated torque (1: Enabled)</td> </tr> <tr> <td>Bit 26</td> <td>Maximum torque/40000000 hex</td> </tr> <tr> <td>Bits 27 to 31</td> <td>Reserved (0: Disabled).</td> </tr> </tbody> </table>								Speed Units		Bit 0	Reference units/s (1: Enabled)	Bit 1	Reference units/min (1: Enabled)	Bit 2	Percentage (%) of rated speed (1: Enabled)	Bit 3	min ⁻¹ (rpm) (1: Enabled)	Bit 4	Maximum motor speed/4000000 hex (1: Enabled)	Bits 5 to 7	Reserved (0: Disabled).	Position Units		Bit 8	Reference units (1: Enabled)	Bits 9 to 15	Reserved (0: Disabled).	Acceleration Units		Bit 16	Reference units/s ² (1: Enabled)	Bit 17	ms (acceleration time required to reach rated speed) (0: Disabled)	Bits 18 to 23	Reserved (0: Disabled).	Torque Units		Bit 24	N·m (0: Disabled)	Bit 25	Percentage (%) of rated torque (1: Enabled)	Bit 26	Maximum torque/40000000 hex	Bits 27 to 31	Reserved (0: Disabled).
		Speed Units																																													
		Bit 0	Reference units/s (1: Enabled)																																												
		Bit 1	Reference units/min (1: Enabled)																																												
		Bit 2	Percentage (%) of rated speed (1: Enabled)																																												
		Bit 3	min ⁻¹ (rpm) (1: Enabled)																																												
		Bit 4	Maximum motor speed/4000000 hex (1: Enabled)																																												
		Bits 5 to 7	Reserved (0: Disabled).																																												
		Position Units																																													
		Bit 8	Reference units (1: Enabled)																																												
		Bits 9 to 15	Reserved (0: Disabled).																																												
		Acceleration Units																																													
		Bit 16	Reference units/s ² (1: Enabled)																																												
		Bit 17	ms (acceleration time required to reach rated speed) (0: Disabled)																																												
		Bits 18 to 23	Reserved (0: Disabled).																																												
		Torque Units																																													
		Bit 24	N·m (0: Disabled)																																												
		Bit 25	Percentage (%) of rated torque (1: Enabled)																																												
		Bit 26	Maximum torque/40000000 hex																																												
Bits 27 to 31	Reserved (0: Disabled).																																														

Continued on next page.

Continued from previous page.

Parameter No.	Size	Name	Setting Range	Setting Unit [Resolution]	Default Setting	Applicable Motors	When Enabled	Classification
61 PnAC2	4	Speed Loop Gain	1,000 to 2,000,000	0.001 Hz [0.1 Hz]	40000	All	Immediately	Tuning
62 PnAC4	4	Speed Loop Integral Time Constant	150 to 512,000	1 μs [0.01 ms]	20000	All	Immediately	
63 PnAC6	4	Position Loop Gain	1,000 to 2,000,000	0.001/s [0.1/s]	40000	All	Immediately	
64 PnAC8	4	Feedforward Compensation	0 to 100	1%	0	All	Immediately	
65 PnACA	4	Position Loop Integral Time Constant	0 to 5,000,000	1 μs [0.1 ms]	0	All	Immediately	
66 PnACC	4	Positioning Completed Width	0 to 1,073,741,824	1 reference unit	7	All	Immediately	
67 PnACE	4	Near Signal Width	1 to 1,073,741,824	1 reference unit	1073741824	All	Immediately	
81 PnB02	4	Exponential Acceleration/Deceleration Time Constant	0 to 510,000	1 μs [0.1 ms]	0	All	Immediately*6	
82 PnB04	4	Movement Average Time	0 to 510,000	1 μs [0.1 ms]	0	All	Immediately*6	
83 PnB06	4	External Positioning Final Travel Distance	-1,073,741,823 to 1,073,741,823	1 reference unit	100	All	Immediately	
84 PnB08	4	Origin Approach Speed	0 to 3FFFFFFF hex	10 ⁻³ min ⁻¹	× 5,000 reference units/s converted to 10 ⁻³ min ⁻¹	All	Immediately	
85 PnB0A	4	Origin Return Creep Speed	0 to 3FFFFFFF hex	10 ⁻³ min ⁻¹	× 500 reference units/s converted to 10 ⁻³ min ⁻¹	All	Immediately	
86 PnB0C	4	Final Travel Distance for Origin Return	-1,073,741,823 to 1,073,741,823	1 reference unit	100	All	Immediately	
87 PnB0E	4	Fixed Monitor Selection 1	0 to F	-	1	All	Immediately	
		0000 hex	APOS					
		0001 hex	CPOS					
		0002 hex	PERR					
		0003 hex	LPOS1					
		0004 hex	LPOS2					
		0005 hex	FSPD					
		0006 hex	CSPD					
		0007 hex	TRQ					
		0008 hex	ALARM					
		0009 hex	MPOS					
		000A hex	Reserved (undefined value).					
		000B hex	Reserved (undefined value).					
		000C hex	CMN1 (common monitor 1)					
		000D hex	CMN2 (common monitor 2)					
		000E hex	OMN1 (optional monitor 1)					
000F hex	OMN2 (optional monitor 2)							

Continued on next page.

5.2.3 List of MECHATROLINK-III Common Parameters

Continued from previous page.

Parameter No.	Size	Name	Setting Range	Setting Unit [Resolution]	Default Setting	Applicable Motors	When Enabled	Classification	
88 PnB10	4	Fixed Monitor Selection 2	0 to F	-	0	All	Immediately		
		0000 to 000F hex	The settings are the same as those for Fixed Monitor Selection 1.						
89 PnB12	4	SEL_MON (CMN1) Monitor Selection 1	0 to 9	-	0	All	Immediately	Command-related parameters	
		0000 hex	TPOS (target position in reference coordinate system)						
		0001 hex	IPOS (reference position in reference coordinate system)						
		0002 hex	POS_OFFSET (offset set in POS_SET (Set Coordinate System) command)						
		0003 hex	TSPD (target speed)						
		0004 hex	SPD_LIM (speed limit)						
		0005 hex	TRQ_LIM (torque limit)						
			SV_STAT (servo actual operating status) Monitor Description Byte 1: Current communications phase 00 hex: Phase 0 01 hex: Phase 1 02 hex: Phase 2 03 hex: Phase 3 Byte 2: Current control mode 00 hex: Position control mode 01 hex: Speed control mode 02 hex: Torque control mode Byte 3: Reserved Byte 4: Expansion signal monitor						
		0006 hex	Bit 0	LT_RDY1	Processing status for latch detection for LT_REQ1 in SVCM-D_CTRL region	0	Latch detection not yet processed.		
						1	Processing latch detection in progress.		
			Bit 1	LT_RDY1	Processing status for latch detection for LT_REQ2 in SVCM-D_CTRL region	0	Latch detection not yet processed.		
						1	Processing latch detection in progress.		
			Bits 2 and 3	LT_SEL1R	Latch signal	0	Phase C		
	1					External input signal 1			
	2					External input signal 2			
	Bits 4 and 5		LT_SEL2R	Latch signal	0	Phase C			
					1	External input signal 1			
					2	External input signal 2			
		Bit 6	Reserved (0).						
	0007 hex	Reserved.							
	0008 hex	INIT_PGPOS (Low)	Lower 32 bits of initial encoder position converted to 64-bit position reference data						
	0009 hex	INIT_PGPOS (High)	Upper 32 bits of initial encoder position converted to 64-bit position reference data						

Continued on next page.

Continued from previous page.

Parameter No.	Size	Name	Setting Range	Setting Unit [Resolution]	Default Setting	Applicable Motors	When Enabled	Classification		
8A PnB14	4	SEL_MON (CMN2) Monitor Selection 2	0 to 9	–	0	All	Immediately	Command-related parameters		
		0000 to 0009 hex	The settings are the same as those for SEL_MON Monitor Selection 1.							
8B PnB16	4	Origin Detection Width	0 to 250	1 reference unit	10	All	Immediately			
8C PnB18	4	Forward Torque Limit	0 to 800	1%	100	All	Immediately			
8D PnB1A	4	Reverse Torque Limit	0 to 800	1%	100	All	Immediately			
8E PnB1C	4	Zero Speed Detection Range	1,000 to 10,000,000	10 ⁻³ min ⁻¹	20000	All	Immediately			
8F PnB1E	4	Speed Coincidence Signal Detection Width	0 to 100,000	10 ⁻³ min ⁻¹	10000	All	Immediately			
90 PnB20	4	Servo Command Control Field Enable/Disable Selections (read only)	–	–	0FFF3F3F hex	All	–			
		Bit 0	CMD_PAUSE (1: Enabled)							
		Bit 1	CMD_CANCEL (1: Enabled)							
		Bits 2 and 3	STOP_MODE (1: Enabled)							
		Bits 4 and 5	ACCFIL (1: Enabled)							
		Bits 6 and 7	Reserved (0: Disabled).							
		Bit 8	LT_REQ1 (1: Enabled)							
		Bit 9	LT_REQ2 (1: Enabled)							
		Bits 10 and 11	LT_SEL1 (1: Enabled)							
		Bits 12 and 13	LT_SEL2 (1: Enabled)							
		Bits 14 and 15	Reserved (0: Disabled).							
		Bits 16 to 19	SEL_MON1 (1: Enabled)							
		Bits 20 to 23	SEL_MON2 (1: Enabled)							
		Bits 24 to 27	SEL_MON3 (1: Enabled)							
Bits 28 to 31	Reserved (0: Disabled).									

Continued on next page.

5.2.3 List of MECHATROLINK-III Common Parameters

Continued from previous page.

Parameter No.	Size	Name	Setting Range	Setting Unit [Resolution]	Default Setting	Applicable Motors	When Enabled	Classification
91 PnB22	4	Servo Status Field Enable/Disable Selections (read only)	-	-	0FFF3F33 hex	All	-	Command-related parameters
		Bit 0	CMD_PAUSE_CMP (1: Enabled)					
		Bit 1	CMD_CANCEL_CMP (1: Enabled)					
		Bit 2 and 3	Reserved (0: Disabled).					
		Bits 4 and 5	ACCFIL (1: Enabled)					
		Bits 6 and 7	Reserved (0: Disabled).					
		Bit 8	L_CMP1 (1: Enabled)					
		Bit 9	L_CMP2 (1: Enabled)					
		Bit 10	POS_RDY (1: Enabled)					
		Bit 11	PON (1: Enabled)					
		Bit 12	M_RDY (1: Enabled)					
		Bit 13	SV_ON (1: Enabled)					
		Bits 14 and 15	Reserved (0: Disabled).					
		Bits 16 to 19	SEL_MON1 (1: Enabled)					
		Bits 20 to 23	SEL_MON2 (1: Enabled)					
		Bits 24 to 27	SEL_MON3 (1: Enabled)					
Bits 28 to 31	Reserved (0: Disabled).							
92 PnB24	4	Output Bit Enable/Disable Selections (read only)	-	-	007F01F0 hex	All	-	Command-related parameters
		Bits 0 to 3	Reserved (0: Disabled).					
		Bit 4	V_PPI (1: Enabled)					
		Bit 5	P_PPI (1: Enabled)					
		Bit 6	P_CL (1: Enabled)					
		Bit 7	N_CL (1: Enabled)					
		Bit 8	G_SEL (1: Enabled)					
		Bits 9 to 11	G_SEL (0: Disabled)					
		Bits 12 to 15	Reserved (0: Disabled).					
		Bits 16 to 19	BANK_SEL (1: Enabled)					
		Bits 20 to 22	SO1 to SO3 (1: Enabled)					
		Bit 23	Reserved (0: Disabled).					
		Bits 24 to 31	Reserved (0: Disabled).					

Continued on next page.

Continued from previous page.

Parameter No.	Size	Name	Setting Range	Setting Unit [Resolution]	Default Setting	Applicable Motors	When Enabled	Classification	
93 PnB26	4	Input Bit Enable/Disable Selections (read only)	–	–	FF0FFEFE hex	All	–	Command-related parameters	
		Bit 0	Reserved (0: Disabled).						
		Bit 1	DEC (1: Enabled)						
		Bit 2	P-OT (1: Enabled)						
		Bit 3	N-OT (1: Enabled)						
		Bit 4	EXT1 (1: Enabled)						
		Bit 5	EXT2 (1: Enabled)						
		Bit 6	EXT3 (1: Enabled)						
		Bit 7	ESTP (1: Enabled)						
		Bit 8	Reserved (0: Disabled).						
		Bit 9	BRK_ON (1: Enabled)						
		Bit 10	P-SOT (1: Enabled)						
		Bit 11	N-SOT (1: Enabled)						
		Bit 12	DEN (1: Enabled)						
		Bit 13	NEAR (1: Enabled)						
		Bit 14	PSET (1: Enabled)						
		Bit 15	ZPOINT (1: Enabled)						
		Bit 16	T_LIM (1: Enabled)						
		Bit 17	V_LIM (1: Enabled)						
		Bit 18	V_CMP (1: Enabled)						
		Bit 19	ZSPD (1: Enabled)						
	Bits 20 to 23	Reserved (0: Disabled).							
	Bits 24 to 31	IO_STS1 to IO_STS8 (1: Enabled)							

*1. The parameter setting is enabled after SENS_ON command execution is completed.

*2. When using fully-closed loop control, set the reference units/s.

*3. If you set the Speed Unit Selection (parameter 41) to either 0002 hex or 0003 hex, set the Speed Base Unit Selection (parameter 42) to a number between -3 and 0.

*4. If you set the Speed Unit Selection (parameter 41) to 0004 hex, set the Speed Base Unit Selection (parameter 42) to 0.

*5. If you set the Torque Unit Selection (parameter 47) to 0002 hex, set the Torque Base Unit Selection (parameter 48) to 0.

*6. Change the setting when the reference is stopped (i.e., while DEN is set to 1). If you change the setting during operation, the reference output will be affected.

5.2.4 Parameter Recording Table

Use the following table to record the settings of the parameters.

Parameter No.	Default Setting					Name	When Enabled
Pn000	0000					Basic Function Selections 0	After restart
Pn001	0000					Application Function Selections 1	After restart
Pn002	0011					Application Function Selections 2	After restart
Pn006	0002					Application Function Selections 6	Immediately
Pn007	0000					Application Function Selections 7	Immediately
Pn008	4000					Application Function Selections 8	After restart
Pn009	0010					Application Function Selections 9	After restart
Pn00A	0001					Application Function Selections A	After restart
Pn00B	0000					Application Function Selections B	After restart
Pn00C	0000					Application Function Selections C	After restart
Pn00D	0000					Application Function Selections D	After restart
Pn00F	0000					Application Function Selections F	After restart
Pn021	0000					Reserved parameter	–
Pn040	0000					Σ -V Compatible Function Switch	After restart
Pn080	0000					Application Function Selections 80	After restart
Pn081	0000					Application Function Selections 81	After restart
Pn100	400					Speed Loop Gain	Immediately
Pn101	2000					Speed Loop Integral Time Constant	Immediately
Pn102	400					Position Loop Gain	Immediately
Pn103	100					Moment of Inertia Ratio	Immediately
Pn104	400					Second Speed Loop Gain	Immediately
Pn105	2000					Second Speed Loop Integral Time Constant	Immediately
Pn106	400					Second Position Loop Gain	Immediately
Pn109	0					Feedforward	Immediately
Pn10A	0					Feedforward Filter Time Constant	Immediately
Pn10B	0004					Gain Application Selections	*1
Pn10C	200					Mode Switching Level for Torque Reference	Immediately
Pn10D	0					Mode Switching Level for Speed Reference	Immediately
Pn10E	0					Mode Switching Level for Acceleration	Immediately
Pn10F	0					Mode Switching Level for Position Deviation	Immediately

Continued on next page.

Continued from previous page.

Parameter No.	Default Setting				Name	When Enabled
Pn11F	0				Position Integral Time Constant	Immediately
Pn121	100				Friction Compensation Gain	Immediately
Pn122	100				Second Friction Compensation Gain	Immediately
Pn123	0				Friction Compensation Coefficient	Immediately
Pn124	0				Friction Compensation Frequency Correction	Immediately
Pn125	100				Friction Compensation Gain Correction	Immediately
Pn131	0				Gain Switching Time 1	Immediately
Pn132	0				Gain Switching Time 2	Immediately
Pn135	0				Gain Switching Waiting Time 1	Immediately
Pn136	0				Gain Switching Waiting Time 2	Immediately
Pn139	0000				Automatic Gain Switching Selections 1	Immediately
Pn13D	2000				Current Gain Level	Immediately
Pn13F	0				Less-Deviation Control 2 Second Position Integral Time Constant	Immediately
Pn140	0100				Model Following Control-Related Selections	Immediately
Pn141	500				Model Following Control Gain	Immediately
Pn142	1000				Model Following Control Gain Correction	Immediately
Pn143	1000				Model Following Control Bias in the Forward Direction	Immediately
Pn144	1000				Model Following Control Bias in the Reverse Direction	Immediately
Pn145	500				Vibration Suppression 1 Frequency A	Immediately
Pn146	700				Vibration Suppression 1 Frequency B	Immediately
Pn147	1000				Model Following Control Speed Feedforward Compensation	Immediately
Pn148	500				Second Model Following Control Gain	Immediately
Pn149	1000				Second Model Following Control Gain Correction	Immediately
Pn14A	800				Vibration Suppression 2 Frequency	Immediately
Pn14B	100				Vibration Suppression 2 Correction	Immediately
Pn14F	0021				Control-Related Selections	After restart
Pn160	0010				Anti-Resonance Control-Related Selections	Immediately
Pn161	1000				Anti-Resonance Frequency	Immediately
Pn162	100				Anti-Resonance Gain Correction	Immediately

Continued on next page.

Continued from previous page.

Parameter No.	Default Setting					Name	When Enabled
Pn163	0					Anti-Resonance Damping Gain	Immediately
Pn164	0					Anti-Resonance Filter Time Constant 1 Correction	Immediately
Pn165	0					Anti-Resonance Filter Time Constant 2 Correction	Immediately
Pn166	0					Anti-Resonance Damping Gain 2	Immediately
Pn170	1400					Tuning-less Function-Related Selections	*1
Pn181	0					Mode Switching Level for Speed Reference	Immediately
Pn182	0					Mode Switching Level for Acceleration	Immediately
Pn190	0100					Less-Deviation Control-Related Switches	After restart
Pn191	1000					Less-Deviation Control 1 Feedforward Gain	Immediately
Pn192	1000					Less-Deviation Control 1 Second Feedforward Gain	Immediately
Pn193	30					Less-Deviation Control 1 Feedforward Filter Time Constant	Immediately
Pn195	2102					Less-Deviation Function Selection Switches	After restart
Pn196	1000					Less-Deviation Control 2 Speed Feedforward Gain	Immediately
Pn197	50					Less-Deviation Control 2 Torque Feedforward Filter Time Constant	Immediately
Pn198	1000					Less-Deviation Control 2 Forward Torque Feedforward Gain	Immediately
Pn199	1000					Less-Deviation Control 2 Reverse Torque Feedforward Gain	Immediately
Pn19A	10000					Less-Deviation Control 2 Incomplete Integration Rate	Immediately
Pn19B	0					Less-Deviation Control 2 Rotary Servomotor Viscous Friction Compensation Coefficient	Immediately
Pn19C	0					Reserved parameter	Immediately
Pn19D	0					Less-Deviation Control 2 Linear Servomotor Viscous Friction Compensation Coefficient	Immediately
Pn19E	0					Reserved parameter	Immediately
Pn19F	0					Less-Deviation Control 2 Torque Feedforward Moving Average Time	Immediately
Pn1A4	36					Reserved parameter	Immediately
Pn1A5	0					Reserved parameter	Immediately
Pn1AE	0					Reserved parameter	Immediately
Pn1AF	0					Reserved parameter	Immediately
Pn205	65535					Multiturn Limit	After restart

Continued on next page.

Continued from previous page.

Parameter No.	Default Setting				Name	When Enabled
Pn207	1000				Position Control Function Selections	After restart
Pn20A	32768				Number of External Scale Pitches	After restart
Pn20E	16				Electronic Gear Ratio (Numerator)	After restart
Pn210	1				Electronic Gear Ratio (Denominator)	After restart
Pn212	2048				Number of Encoder Output Pulses	After restart
Pn22A	0000				Fully-closed Control Selections	After restart
Pn230	0000				Position Control Expansion Function Selections	After restart
Pn231	0				Backlash Compensation	Immediately
Pn233	0				Backlash Compensation Time Constant	Immediately
Pn234	0				Second Position Reference Acceleration/Deceleration Time Constant	Immediately
Pn281	20				Encoder Output Resolution	After restart
Pn282	0				Linear Encoder Scale Pitch	After restart
Pn304	500				Jogging Speed	Immediately
Pn305	0				Soft Start Acceleration Time	Immediately
Pn306	0				Soft Start Deceleration Time	Immediately
Pn308	0				Speed Feedback Filter Time Constant	Immediately
Pn30A	0				Deceleration Time for Servo OFF and Forced Stops	Immediately
Pn30C	0				Speed Feedforward Average Movement Time	Immediately
Pn310	0000				Vibration Detection Selections	Immediately
Pn311	100				Vibration Detection Sensitivity	Immediately
Pn312	50				Vibration Detection Level	Immediately
Pn316	10000				Maximum Motor Speed	After restart
Pn324	300				Moment of Inertia Calculation Starting Level	Immediately
Pn383	50				Jogging Speed	Immediately
Pn384	10				Vibration Detection Level	Immediately
Pn385	50				Maximum Motor Speed	After restart
Pn401	100				First Stage First Torque Reference Filter Time Constant	Immediately
Pn402	800				Forward Torque Limit	Immediately
Pn403	800				Reverse Torque Limit	Immediately
Pn404	100				Forward External Torque Limit	Immediately
Pn405	100				Reverse External Torque Limit	Immediately
Pn406	800				Emergency Stop Torque	Immediately

Continued on next page.

Continued from previous page.

Parameter No.	Default Setting					Name	When Enabled
Pn407	10000					Speed Limit during Torque Control	Immediately
Pn408	0000					Torque-Related Function Selections	*1
Pn409	5000					First Stage Notch Filter Frequency	Immediately
Pn40A	70					First Stage Notch Filter Q Value	Immediately
Pn40B	0					First Stage Notch Filter Depth	Immediately
Pn40C	5000					Second Stage Notch Filter Frequency	Immediately
Pn40D	70					Second Stage Notch Filter Q Value	Immediately
Pn40E	0					Second Stage Notch Filter Depth	Immediately
Pn40F	5000					Second Stage Second Torque Reference Filter Frequency	Immediately
Pn410	50					Second Stage Second Notch Filter Q Value	Immediately
Pn412	100					First Stage Second Torque Reference Filter Time Constant	Immediately
Pn416	0000					Torque-Related Function Selections 2	Immediately
Pn417	5000					Third Stage Notch Filter Frequency	Immediately
Pn418	70					Third Stage Notch Filter Q Value	Immediately
Pn419	0					Third Stage Notch Filter Depth	Immediately
Pn41A	5000					Fourth Stage Notch Filter Frequency	Immediately
Pn41B	70					Fourth Stage Notch Filter Q Value	Immediately
Pn41C	0					Fourth Stage Notch Filter Depth	Immediately
Pn41D	5000					Fifth Stage Notch Filter Frequency	Immediately
Pn41E	70					Fifth Stage Notch Filter Q Value	Immediately
Pn41F	0					Fifth Stage Notch Filter Depth	Immediately
Pn423	0000					Speed Ripple Compensation Selections	*1
Pn424	50					Torque Limit at Main Circuit Voltage Drop	Immediately
Pn425	100					Release Time for Torque Limit at Main Circuit Voltage Drop	Immediately
Pn426	0					Torque Feedforward Average Movement Time	Immediately
Pn427	0					Speed Ripple Compensation Enable Speed	Immediately
Pn456	15					Sweep Torque Reference Amplitude	Immediately

Continued on next page.

Continued from previous page.

Parameter No.	Default Setting				Name	When Enabled
Pn460	0101				Notch Filter Adjustment Selections 1	Immediately
Pn480	10000				Speed Limit during Force Control	Immediately
Pn481	400				Polarity Detection Speed Loop Gain	Immediately
Pn482	3000				Polarity Detection Speed Loop Integral Time Constant	Immediately
Pn483	30				Forward Force Limit	Immediately
Pn484	30				Reverse Force Limit	Immediately
Pn485	20				Polarity Detection Reference Speed	Immediately
Pn486	25				Polarity Detection Reference Acceleration/Deceleration Time	Immediately
Pn487	0				Polarity Detection Constant Speed Time	Immediately
Pn488	100				Polarity Detection Reference Waiting Time	Immediately
Pn48E	10				Polarity Detection Range	Immediately
Pn490	100				Polarity Detection Load Level	Immediately
Pn495	100				Polarity Detection Confirmation Force Reference	Immediately
Pn498	10				Polarity Detection Allowable Error Range	Immediately
Pn49F	0				Speed Ripple Compensation Enable Speed	Immediately
Pn502	20				Rotation Detection Level	Immediately
Pn503	10				Speed Coincidence Detection Signal Output Width	Immediately
Pn506	0				Brake Reference-Servo OFF Delay Time	Immediately
Pn507	100				Brake Reference Output Speed Level	Immediately
Pn508	50				Servo OFF-Brake Command Waiting Time	Immediately
Pn509	20				Momentary Power Interruption Hold Time	Immediately
Pn50A	1881				Input Signal Selections 1	After restart
Pn50B	8882				Input Signal Selections 2	After restart
Pn50E	0000				Output Signal Selections 1	After restart
Pn50F	0100				Output Signal Selections 2	After restart
Pn510	0000				Output Signal Selections 3	After restart
Pn511	6543				Input Signal Selections 5	After restart
Pn512	0000				Output Signal Inverse Settings	After restart
Pn514	0000				Output Signal Selections 4	After restart
Pn516	8888				Input Signal Selections 7	After restart
Pn51B	1000				Motor-Load Position Deviation Overflow Detection Level	Immediately
Pn51E	100				Position Deviation Overflow Warning Level	Immediately

Continued on next page.

Continued from previous page.

Parameter No.	Default Setting				Name	When Enabled
Pn520	5242880				Position Deviation Overflow Alarm Level	Immediately
Pn522	7				Positioning Completed Width	Immediately
Pn524	1073741824				Near Signal Width	Immediately
Pn526	5242880				Position Deviation Overflow Alarm Level at Servo ON	Immediately
Pn528	100				Position Deviation Overflow Warning Level at Servo ON	Immediately
Pn529	10000				Speed Limit Level at Servo ON	Immediately
Pn52A	20				Multiplier per Fully-closed Rotation	Immediately
Pn52B	20				Overload Warning Level	Immediately
Pn52C	100				Base Current Derating at Motor Overload Detection	After restart
Pn52D	50				Reserved parameter	–
Pn530	0000				Program Jogging-Related Selections	Immediately
Pn531	32768				Program Jogging Travel Distance	Immediately
Pn533	500				Program Jogging Movement Speed	Immediately
Pn534	100				Program Jogging Acceleration/Deceleration Time	Immediately
Pn535	100				Program Jogging Waiting Time	Immediately
Pn536	1				Program Jogging Number of Movements	Immediately
Pn550	0				Analog Monitor 1 Offset Voltage	Immediately
Pn551	0				Analog Monitor 2 Offset Voltage	Immediately
Pn552	100				Analog Monitor 1 Magnification	Immediately
Pn553	100				Analog Monitor 2 Magnification	Immediately
Pn55A	1				Power Consumption Monitor Unit Time	Immediately
Pn560	400				Residual Vibration Detection Width	Immediately
Pn561	100				Overshoot Detection Level	Immediately
Pn581	20				Zero Speed Level	Immediately
Pn582	10				Speed Coincidence Detection Signal Output Width	Immediately
Pn583	10				Brake Reference Output Speed Level	Immediately
Pn584	10000				Speed Limit Level at Servo ON	Immediately
Pn585	50				Program Jogging Movement Speed	Immediately
Pn586	0				Motor Running Cooling Ratio	Immediately

Continued on next page.

Continued from previous page.

Parameter No.	Default Setting				Name	When Enabled
Pn587	0000				Polarity Detection Execution Selection for Absolute Linear Encoder	Immediately
Pn600	0				Regenerative Resistor Capacity	Immediately
Pn601	0				Dynamic Brake Resistor Allowable Energy Consumption	After restart
Pn603	0				Regenerative Resistance	Immediately
Pn604	0				Dynamic Brake Resistance	After restart
Pn800	1040				Communications Controls	Immediately
Pn801	0003				Application Function Selections 6 (Software Limits)	Immediately
Pn803	10				Origin Range	Immediately
Pn804	1073741823				Forward Software Limit	Immediately
Pn806	-1073741823				Reverse Software Limit	Immediately
Pn808	0				Absolute Encoder Origin Offset	Immediately ^{*2}
Pn80A	100				First Stage Linear Acceleration Constant	Immediately ^{*3}
Pn80B	100				Second Stage Linear Acceleration Constant	Immediately ^{*3}
Pn80C	0				Acceleration Constant Switching Speed	Immediately ^{*3}
Pn80D	100				First Stage Linear Deceleration Constant	Immediately ^{*3}
Pn80E	100				Second Stage Linear Deceleration Constant	Immediately ^{*3}
Pn80F	0				Deceleration Constant Switching Speed	Immediately ^{*3}
Pn810	0				Exponential Acceleration/Deceleration Bias	Immediately ^{*3}
Pn811	0				Exponential Acceleration/Deceleration Time Constant	Immediately ^{*3}
Pn812	0				Movement Average Time	Immediately ^{*3}
Pn814	100				External Positioning Final Travel Distance	Immediately ^{*3}
Pn816	0000				Origin Return Mode Settings	Immediately ^{*3}
Pn817	50				Origin Approach Speed 1	Immediately ^{*3}
Pn818	5				Origin Approach Speed 2	Immediately ^{*3}
Pn819	100				Final Travel Distance for Origin Return	Immediately ^{*3}
Pn81E	0000				Input Signal Monitor Selections	Immediately
Pn81F	0010				Command Data Allocations	After restart
Pn820	0				Forward Latching Area	Immediately
Pn822	0				Reverse Latching Area	Immediately
Pn824	0000				Option Monitor 1 Selection	Immediately
Pn825	0000				Option Monitor 2 Selection	Immediately

Continued on next page.

Continued from previous page.

Parameter No.	Default Setting					Name	When Enabled
Pn827	100					Linear Deceleration Constant 1 for Stopping	Immediately ^{*3}
Pn829	0					SVOFF Waiting Time (for SVOFF at Deceleration to Stop)	Immediately
Pn82A	1813					Option Field Allocations 1	After restart
Pn82B	1D1C					Option Field Allocations 2	After restart
Pn82C	1F1E					Option Field Allocations 3	After restart
Pn82D	0000					Option Field Allocations 4	After restart
Pn82E	0000					Option Field Allocations 5	After restart
Pn833	0000					Motion Settings	After restart
Pn834	100					First Stage Linear Acceleration Constant 2	Immediately ^{*3}
Pn836	100					Second Stage Linear Acceleration Constant 2	Immediately ^{*3}
Pn838	0					Acceleration Constant Switching Speed 2	Immediately ^{*3}
Pn83A	100					First Stage Linear Deceleration Constant 2	Immediately ^{*3}
Pn83C	100					Second Stage Linear Deceleration Constant 2	Immediately ^{*3}
Pn83E	0					Deceleration Constant Switching Speed 2	Immediately ^{*3}
Pn840	100					Linear Deceleration Constant 2 for Stopping	Immediately ^{*3}
Pn842	0					Second Origin Approach Speed 1	Immediately ^{*3}
Pn844	0					Second Origin Approach Speed 2	Immediately ^{*3}
Pn846	0					POSING Command Scurve Acceleration/Deceleration Rate	Immediately ^{*3}
Pn850	0					Number of Latch Sequences	Immediately
Pn851	0					Continuous Latch Sequence Count	Immediately
Pn852	0000					Latch Sequence 1 to 4 Settings	Immediately
Pn853	0000					Latch Sequence 5 to 8 Settings	Immediately
Pn860	0000					SVCMD_IO Input Signal Monitor Allocations 1	Immediately
Pn861	0000					SVCMD_IO Input Signal Monitor Allocations 2	Immediately
Pn862	0000					SVCMD_IO Input Signal Monitor Allocations 3	Immediately
Pn863	0000					SVCMD_IO Input Signal Monitor Allocations 4	Immediately
Pn868	0000					SVCMD_IO Output Signal Monitor Allocations 1	Immediately
Pn869	0000					SVCMD_IO Output Signal Monitor Allocations 2	Immediately
Pn880	0					Station Address Monitor (for maintenance, read only)	Immediately

Continued on next page.

Continued from previous page.

Parameter No.	Default Setting				Name	When Enabled
Pn881	0				Set Transmission Byte Count Monitor [bytes] (for maintenance, read only)	Immediately
Pn882	0				Transmission Cycle Setting Monitor [$\times 0.25 \mu\text{s}$] (for maintenance, read only)	Immediately
Pn883	0				Communications Cycle Setting Monitor [transmission cycles] (for maintenance, read only)	Immediately
Pn884	0000				Communications Controls 2	Immediately
Pn88A	0				MECHATROLINK Receive Error Counter Monitor (for maintenance, read only)	Immediately
Pn890 to Pn8A6	0				Command Data Monitor during Alarm/Warning (for maintenance, read only)	Immediately
Pn8A8 to Pn8BE	0				Response Data Monitor during Alarm/Warning (for maintenance, read only)	Immediately
Pn900	0				Number of Parameter Banks	After restart
Pn901	0				Number of Parameter Bank Members	After restart
Pn902 to Pn910	0				Parameter Bank Member Definition	After restart
Pn920 to Pn95F	0				Parameter Bank Data (Not saved in nonvolatile memory.)	Immediately
01 PnA02	–				Encoder Type Selection (read only)	–
02 PnA04	–				Motor Type Selection (read only)	–
03 PnA06	–				Semi-closed/Fully-closed Selection (read only)	–
04 PnA08	–				Rated Motor Speed (read only)	–
05 PnA0A	–				Maximum Output Speed (read only)	–
06 PnA0C	–				Speed Multiplier (read only)	–
07 PnA0E	–				Rated Torque (read only)	–
08 PnA10	–				Maximum Output Torque (read only)	–
09 PnA12	–				Torque Multiplier (read only)	–
0A PnA14	–				Resolution (read only)	–
0B PnA16	0				Scale Pitch	After restart
0C PnA18	–				Pulses per Scale Pitch (read only)	–
21 PnA42	16				Electronic Gear Ratio (Numerator)	After restart

Continued on next page.

Continued from previous page.

Parameter No.	Default Setting					Name	When Enabled
22 PnA44	1					Electronic Gear Ratio (Denominator)	After restart
23 PnA46	0					Absolute Encoder Origin Offset	Immediately* ²
24 PnA48	65535					Multiturn Limit Setting	After restart
25 PnA4A	0000 hex					Limit Setting	After restart
26 PnA4C	1073741823					Forward Software Limit	Immediately
27 PnA4E	0					Reserved parameter (Do not change.)	Immediately
28 PnA50	-1073741823					Reverse Software Limit	Immediately
29 PnA52	0					Reserved parameter (Do not change.)	Immediately
41 PnA82	0					Speed Unit Selection	After restart
42 PnA84	0					Speed Base Unit Selection	After restart
43 PnA86	0					Position Unit Selection	After restart
44 PnA88	0					Position Base Unit Selection	After restart
45 PnA8A	0					Acceleration Unit Selection	After restart
46 PnA8C	4					Acceleration Base Unit Selection	After restart
47 PnA8E	1					Torque Unit Selection	After restart
48 PnA90	0					Torque Base Unit Selection	After restart
49 PnA92	0601011F hex					Supported Unit Systems (read only)	-
61 PnAC2	40000					Speed Loop Gain	Immediately
62 PnAC4	20000					Speed Loop Integral Time Constant	Immediately
63 PnAC6	40000					Position Loop Gain	Immediately
64 PnAC8	0					Feedforward Compensation	Immediately
65 PnACA	0					Position Loop Integral Time Constant	Immediately
66 PnACC	7					Positioning Completed Width	Immediately
67 PnACE	1073741824					Near Signal Width	Immediately
81 PnB02	0					Exponential Acceleration/Deceleration Time Constant	Immediately* ³
82 PnB04	0					Movement Average Time	Immediately* ³
83 PnB06	100					External Positioning Final Travel Distance	Immediately

Continued on next page.

Continued from previous page.

Parameter No.	Default Setting				Name	When Enabled
84 PnB08	× 5,000 reference units/s converted to 10^{-3} min^{-1}				Origin Approach Speed	Immediately
85 PnB0A	× 500 reference units/s converted to 10^{-3} min^{-1}				Origin Return Creep Speed	Immediately
86 PnB0C	100				Final Travel Distance for Origin Return	Immediately
87 PnB0E	1				Fixed Monitor Selection 1	Immediately
88 PnB10	0				Fixed Monitor Selection 2	Immediately
89 PnB12	0				SEL_MON (CMN1) Monitor Selection 1	Immediately
8A PnB14	0				SEL_MON (CMN2) Monitor Selection 2	Immediately
8B PnB16	10				Origin Detection Width	Immediately
8C PnB18	100				Forward Torque Limit	Immediately
8D PnB1A	100				Reverse Torque Limit	Immediately
8E PnB1C	20000				Zero Speed Detection Range	Immediately
8F PnB1E	10000				Speed Coincidence Signal Detection Width	Immediately
90 PnB20	0FFF3F3F hex				Servo Command Control Field Enable/Disable Selections (read only)	–
91 PnB22	0FFF3F33 hex				Servo Status Field Enable/Disable Selections (read only)	–
92 PnB24	007F01F0 hex				Output Bit Enable/Disable Selections (read only)	–
93 PnB26	FF0FFEFE hex				Input Bit Enable/Disable Selections (read only)	–

*1. The enable timing depends on the digit that is changed. Refer to the following section for details.

 5.2.2 List of Servo Parameters on page 5-44

 5.2.3 List of MECHATROLINK-III Common Parameters on page 5-84

*2. The parameter setting is enabled after SENS_ON command execution is completed.

*3. Change the setting when the reference is stopped (i.e., while DEN is set to 1). If you change the setting during operation, the reference output will be affected.

Index

A

adjustment procedure - - - - - 3-12

adjustment procedures- - - - - 3-4

advanced autotuning with reference - - - - - 1-8

advanced autotuning without reference - - - - - 1-8

alarm code output - - - - - 4-2

automatic gain switching- - - - - 1-8

B

base block (BB) - - - - - ix

C

coefficient of speed fluctuation - - - - - 2-9, 2-12

F

feedforward - - - - - 1-8

L

less-deviation control- - - - - 3-2

Linear Servomotor - - - - - ix

list of alarms- - - - - 4-2, 4-55

list of parameters - - - - - 5-2, 5-43

list of warnings - - - - - 4-38, 4-92

M

Main Circuit Cable - - - - - ix

manual gain switching - - - - - 3-10, 3-15

model following control - - - - - 1-8

O

one-parameter tuning - - - - - 1-8

P

parameter settings recording table - - - - - 5-35, 5-92

parameters

 notation (numeric settings) - - - - - x

 notation (selecting functions) - - - - - x

R

Rotary Servomotor - - - - - ix

S

Servo Drive - - - - - ix

servo lock - - - - - ix

servo OFF - - - - - ix

servo ON - - - - - ix

Servo System - - - - - ix

Servomotor - - - - - ix

SERVOPACK - - - - - ix

 model designations - - - - - 1-3

 specifications - - - - - 2-5

SigmaWin+ - - - - - ix

storage humidity - - - - - 2-5, 2-9

storage temperature - - - - - 2-5, 2-9

surrounding air humidity - - - - - 2-5, 2-9

surrounding air temperature - - - - - 2-5, 2-9

T

troubleshooting alarms - - - - - 4-9, 4-61

troubleshooting warnings - - - - - 4-39, 4-94

tuning-less function - - - - - 1-8

tuning-less level setting - - - - - 1-8

V

vibration suppression - - - - - 1-8

W

warning code output- - - - - 4-38

Revision History

The revision dates and numbers of the revised manuals are given on the bottom of the back cover.

MANUAL NO. SIEP S800001 89A

Published in Japan September 2015

_____ Date of publication

Date of Publication	Rev. No.	Web Rev. No.	Section	Revised Contents
September 2015	—	—	—	First edition
	—	—	—	Based on Japanese product manual, SIJP S800001 89A<0>-1, published in August 2015.

Σ-7-Series AC Servo Drive

Σ-7S SERVOPACK with FT/EX Specification for Tracking Application Product Manual

IRUMA BUSINESS CENTER (SOLUTION CENTER)

480, Kamifujisawa, Iruma, Saitama, 358-8555, Japan
Phone 81-4-2962-5151 Fax 81-4-2962-6138
<http://www.yaskawa.co.jp>

YASKAWA AMERICA, INC.

2121, Norman Drive South, Waukegan, IL 60085, U.S.A.
Phone 1-800-YASKAWA (927-5292) or 1-847-887-7000 Fax 1-847-887-7310
<http://www.yaskawa.com>

YASKAWA ELÉTRICO DO BRASIL LTDA.

777, Avenida Piraporinha, Diadema, São Paulo, 09950-000, Brasil
Phone 55-11-3585-1100 Fax 55-11-3585-1187
<http://www.yaskawa.com.br>

YASKAWA EUROPE GmbH

185, Hauptstraße, Eschborn, 65760, Germany
Phone 49-6196-569-300 Fax 49-6196-569-398
<http://www.yaskawa.eu.com>

YASKAWA ELECTRIC KOREA CORPORATION

9F, Kyobo Securities Bldg, 26-4, Yeouido-dong, Yeongdeungpo-gu, Seoul, 150-737, Korea
Phone 82-2-784-7844 Fax 82-2-784-8495
<http://www.yaskawa.co.kr>

YASKAWA ELECTRIC (SINGAPORE) PTE. LTD.

151, Lorong Chuan, #04-02A, New Tech Park, 556741, Singapore
Phone 65-6282-3003 Fax 65-6289-3003
<http://www.yaskawa.com.sg>

YASKAWA ELECTRIC (THAILAND) CO., LTD.

59, 1st-5th Floor, Flourish Building, Soi Ratchadapisek 18, Ratchadapisek Road, Huaykwang, Bangkok, 10310, Thailand
Phone 66-2-017-0099 Fax 66-2-017-0799
<http://www.yaskawa.co.th>

YASKAWA ELECTRIC (CHINA) CO., LTD.

22F, One Corporate Avenue, No.222, Hubin Road, Shanghai, 200021, China
Phone 86-21-5385-2200 Fax 86-21-5385-3299
<http://www.yaskawa.com.cn>

YASKAWA ELECTRIC (CHINA) CO., LTD. BEIJING OFFICE

Room 1011, Tower W3 Oriental Plaza, No.1, East Chang An Ave.,
Dong Cheng District, Beijing, 100738, China
Phone 86-10-8518-4086 Fax 86-10-8518-4082

YASKAWA ELECTRIC TAIWAN CORPORATION

9F, 16, Nanking E. Rd., Sec. 3, Taipei, 104, Taiwan
Phone 886-2-2502-5003 Fax 886-2-2505-1280

YASKAWA

YASKAWA ELECTRIC CORPORATION

In the event that the end user of this product is to be the military and said product is to be employed in any weapons systems or the manufacture thereof, the export will fall under the relevant regulations as stipulated in the Foreign Exchange and Foreign Trade Regulations. Therefore, be sure to follow all procedures and submit all relevant documentation according to any and all rules, regulations and laws that may apply. Specifications are subject to change without notice for ongoing product modifications and improvements.

© 2015 YASKAWA ELECTRIC CORPORATION

MANUAL NO. SIEP S800001 89A

Published in Japan September 2015

15-8-11

Original instructions